

Treatability Test Report for Calcium Polysulfide in the 100-K Area

Prepared for the U.S. Department of Energy
Assistant Secretary for Environmental Management



**United States
Department of Energy**
P.O. Box 550
Richland, Washington 99352

Approved for Public Release;
Further Dissemination Unlimited

Treatability Test Report for Calcium Polysulfide in the 100-K Area

S. W. Petersen
K. A. Hedquist
Fluor Hanford

Date Published
February 2006

Prepared for the U.S. Department of Energy
Assistant Secretary for Environmental Management



**United States
Department of Energy**
P.O. Box 550
Richland, Washington 99352

Nancy A. Fouad for
Sanis K. Braden
Release Approval 3-8-06
Date

**Approved for Public Release;
Further Dissemination Unlimited**

TRADEMARK DISCLAIMER

Reference herein to any specific commercial product, process, or service by trade name, trademark, manufacturer, or otherwise, does not necessarily constitute or imply its endorsement, recommendation, or favoring by the United States Government or any agency thereof or its contractors or subcontractors.

This report has been reproduced from the best available copy.
Available in paper copy.

Printed in the United States of America

-

CONTENTS

1.0	INTRODUCTION.....	1-1
1.1	BACKGROUND INFORMATION	1-1
1.2	TREATMENT TECHNOLOGY DESCRIPTION	1-4
1.3	TESTING PROCEDURE	1-6
2.0	CONCLUSIONS AND RECOMMENDATIONS.....	2-1
2.1	CONCLUSIONS.....	2-1
2.2	RECOMMENDATIONS	2-1
2.3	EVALUATION WITH RESPECT TO CERCLA CRITERIA	2-2
	2.3.1 Threshold Criteria	2-2
	2.3.2 Balancing Criteria	2-3
3.0	TREATABILITY STUDY APPROACH.....	3-1
3.1	TEST OBJECTIVES AND RATIONALE.....	3-1
3.2	EXPERIMENTAL DESIGN AND PROCEDURE.....	3-2
	3.2.1 Scoping Tests	3-2
	3.2.2 Field Test	3-4
	3.2.3 Equipment and Materials	3-15
3.3	SAMPLING AND ANALYSIS.....	3-16
	3.3.1 Hydrologic Properties	3-17
	3.3.2 Groundwater Chemistry.....	3-18
	3.3.3 Process Data.....	3-19
3.4	DATA MANAGEMENT.....	3-20
3.5	DEVIATIONS FROM THE WORK PLAN.....	3-20
4.0	RESULTS AND DISCUSSION	4-1
4.1	DATA ANALYSIS AND INTERPRETATION	4-1
	4.1.1 Analysis of Slug and Tracer Test Data	4-1
	4.1.2 Analysis of Treatability Test Chemical Data	4-2
	4.1.3 Analysis of Process Data	4-6
	4.1.4 Analysis of Waste	4-7
	4.1.5 Comparison to Test Objectives.....	4-8
4.2	QUALITY ASSURANCE/QUALITY CONTROL	4-8
4.3	COSTS/SCHEDULE FOR PERFORMING THE TREATABILITY STUDY	4-9
4.4	KEY CONTACTS	4-10
5.0	REFERENCES.....	5-1

APPENDICES

A	HYDROLOGIC TEST CHARACTERIZATION RESULTS FOR THE 100-KR-4 ISRM FIELD SITE DEMONSTRATION	A-i
B	ANALYTICAL RESULTS	B-i
C	FLOW DATA FROM TREATABILITY TEST	C-i

FIGURES

Figure 1-1.	Map of 100-KR-4 Operable Unit.	1-2
Figure 1-2.	100-KR-4 Area Plume Showing Treatability Test Site.....	1-3
Figure 1-3.	Areal Extent of Modeled Percent Concentration of Calcium Polysulfide for 100-KR-4 Treatability Test.	1-6
Figure 3-1.	Density and Oxidation/Reduction Potential as a Function of Polysulfide Dose.....	3-4
Figure 3-2.	Map of Wells Used for the 100-KR-4 Treatability Test.	3-7
Figure 3-3.	Reaction Tank used in the Treatability Test.	3-8
Figure 3-4.	Site Plan for the Treatability Test System.....	3-9
Figure 3-5.	Schematic Drawing of the Treatability Test Skid.....	3-11
Figure 3-6.	Treatability Test Skid Before Piping was Connected.	3-12
Figure 4-1.	Plot of Oxidation/Reduction Potential and Dissolved Oxygen of Samples Collected from Well 199-K-126.....	4-3
Figure 4-2.	Plot of Hexavalent Chromium Versus Time for Samples Collected from Well 199-K-126.....	4-4
Figure 4-3.	Nitrate and Nitrite Concentrations in Well 199-K-126.....	4-4
Figure 4-4.	Sulfate Concentrations in Well 199-K-126.....	4-5
Figure 4-5.	Manganese and Arsenic Concentrations in Well 199-K-126.....	4-6
Figure 4-6.	Plot of Cumulative Volume of Groundwater Extracted and Injected During the Treatability Test.....	4-7
Figure 4-7.	Treatability Test Schedule.....	4-10

TABLES

Table 3-1. Data from Field Scoping Tests..... 3-3

Table 3-2. Well Construction Summary..... 3-6

Table 3-3. Sampling Schedule for 100-KR-4 Treatability Test Monitoring. 3-17

Table 3-4. Extraction Well Sampling Dates and the Laboratories. 3-19

Table 3-5. Summary of Total Volume and Average Flow for Treatability Test. 3-20

Table 4-1. Analytical Results of Precipitate Produced from the Treatability Test..... 4-8

Table 4-2. Actual Costs for the Treatability Test (in 1,000s). 4-9

This page intentionally left blank.

TERMS

bgs	below ground surface
CERCLA	<i>Comprehensive Environmental Response, Compensation, and Liability Act of 1980</i>
CPS	calcium polysulfide
ID	identification
ISRM	in situ redox manipulation
NM	not measured
ORP	oxidation/reduction potential
OU	operable unit
SRB	sulfate-reducing bacteria
TBD	to be determined
Tri-Party Agreement	<i>Hanford Federal Facility Agreement and Consent Order</i>
TTP	Treatability Test Plan
WAC	<i>Washington Administrative Code</i>

NOTE: Trademarks and registered trademarks are the property of their respective owners.

METRIC CONVERSION CHART

Into Metric Units			Out of Metric Units		
<i>If You Know</i>	<i>Multiply By</i>	<i>To Get</i>	<i>If You Know</i>	<i>Multiply By</i>	<i>To Get</i>
Length			Length		
inches	25.4	Millimeters	millimeters	0.039	inches
inches	2.54	Centimeters	centimeters	0.394	inches
feet	0.305	Meters	meters	3.281	feet
yards	0.914	Meters	meters	1.094	yards
miles	1.609	Kilometers	kilometers	0.621	miles
Area			Area		
sq. inches	6.452	sq. centimeters	sq. centimeters	0.155	sq. inches
sq. feet	0.093	sq. meters	sq. meters	10.76	sq. feet
sq. yards	0.0836	sq. meters	sq. meters	1.196	sq. yards
sq. miles	2.6	sq. kilometers	sq. kilometers	0.4	sq. miles
acres	0.405	Hectares	hectares	2.47	acres
Mass (weight)			Mass (weight)		
ounces	28.35	Grams	grams	0.035	ounces
pounds	0.454	Kilograms	kilograms	2.205	pounds
ton	0.907	metric ton	metric ton	1.102	ton
Volume			Volume		
teaspoons	5	Milliliters	milliliters	0.033	fluid ounces
tablespoons	15	Milliliters	liters	2.1	pints
fluid ounces	30	Milliliters	liters	1.057	quarts
cups	0.24	Liters	liters	0.264	gallons
pints	0.47	Liters	cubic meters	35.315	cubic feet
quarts	0.95	Liters	cubic meters	1.308	cubic yards
gallons	3.8	Liters			
cubic feet	0.028	cubic meters			
cubic yards	0.765	cubic meters			
Temperature			Temperature		
Fahrenheit	subtract 32, then multiply by 5/9	Celsius	Celsius	multiply by 9/5, then add 32	Fahrenheit
Radioactivity			Radioactivity		
picocuries	37	Millibecquerel	millibecquerel	0.027	picocuries

1.0 INTRODUCTION

This report presents the results of a treatability test performed in the 100-K Area during the summer of 2005. This test used the chemical calcium polysulfide (CPS) to remediate chromium that was present in the groundwater. This treatment also chemically reduced a portion of the aquifer materials to form a permeable reactive barrier that will continue to treat chromium in the groundwater.

This test was conducted to evaluate the practicality and cost-effectiveness of using CPS to remediate chromium in the aquifer, and to gain operational experience in its use. The test also determined important hydrologic information for the 100-K Area aquifer, provided experience in designing systems to implement this type of technology, and revealed several lessons learned that will be valuable if this technology is implemented.

The work described here was performed to satisfy *Hanford Federal Facility Agreement and Consent Order* (Ecology et al. 1989) (Tri-Party Agreement) Milestone M-016-28B, Initiate In-Field Treatability Test Using Calcium Polysulfide at 100-KR-4, which was due July 1, 2005. The test followed a treatability test plan (DOE/RL-2005-05, *Treatability Test Plan for Fixation of Chromium in the Groundwater at 100-K*), which was approved by the U.S. Environmental Protection Agency on January 28, 2005. The treatability test plan included a sampling and analysis plan. Disposal of wastes produced during the course of this test were done in accordance with DOE/RL-97-01, *Interim Waste Management Plan for the 100-HR-3 and 100-KR-4 Operable Units*.

1.1 BACKGROUND INFORMATION

The treatability test area is located in the 100-K Area, which is in the northwestern portion of the Hanford Site (Figure 1-1). Contaminated groundwater in this area is in the 100-KR-4 Operable Unit (OU). The groundwater became contaminated from cooling water discharged from the two plutonium production reactors located in the 100-K Area and operating between 1954 and 1971. These were "single-pass" reactors, where the water used to cool the reactor core was pumped only once through the reactor and then discharged into the ground or directly into the river. This cooling water contained approximately 700 µg/L of hexavalent chromium (Cr^{6+}), added from a stock solution of sodium dichromate ($\text{Na}_2\text{Cr}_2\text{O}_7$) to inhibit corrosion in the reactor. The hexavalent form of chromium found in sodium dichromate is highly mobile and toxic to aquatic organisms, particularly salmon fry.

During reactor operation, much of the reactor cooling water was discharged to the 116-K-2 Trench (DOE/RL-2004-21, *Calendar Year 2003 Annual Summary Report for the 100-HR-3, 100-KR-4, and 100-NR-2 Operable Unit Pump-and-Treat Operations*). This trench is west of the treatability test area (Figure 1-2), approximately 250 m (820 ft) from the Columbia River. The reactor coolant water and other liquids discharged to the trench contained an estimated 300,000 kg (660,000 lbs) of sodium dichromate, as well as other chemical and radiological wastes.

Figure 1-1. Map of 100-KR-4 Operable Unit.

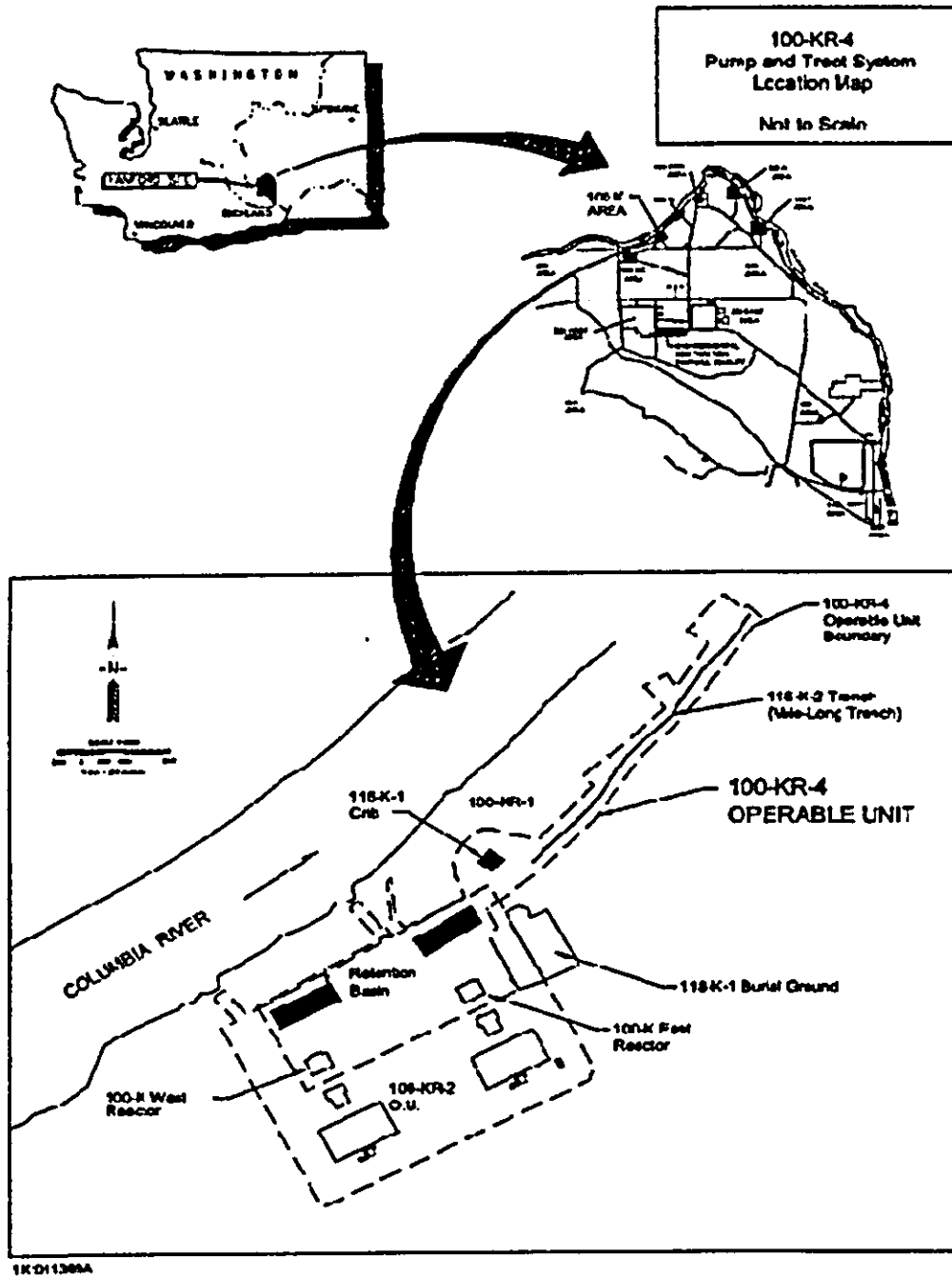
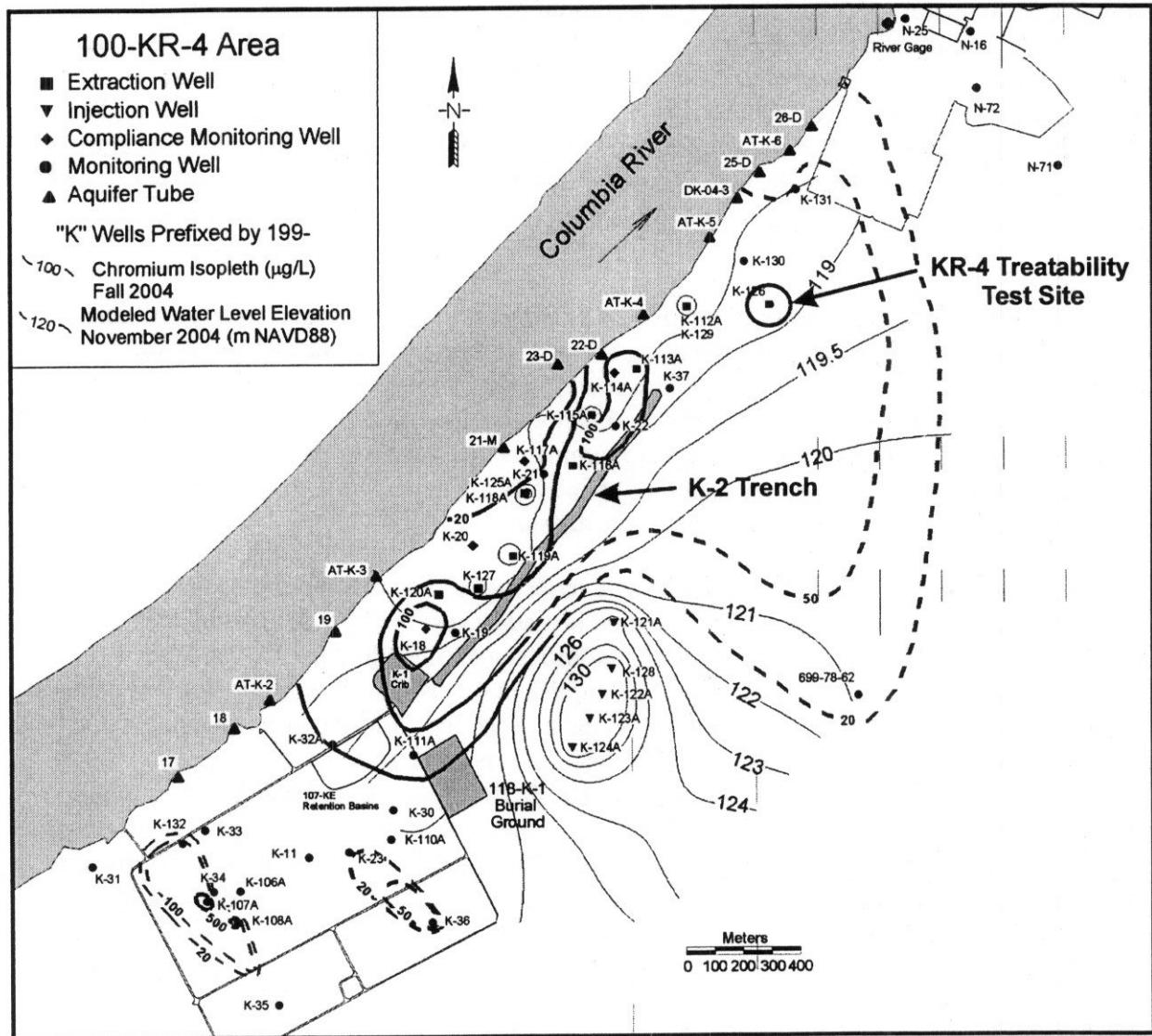

Figure 1-2. 100-KR-4 Area Plume Showing Treatability Test Site.



The depth to groundwater in the treatability test area is approximately 19.8 m (65 ft); the unconfined aquifer is approximately 7.6 m (25 ft) thick. Groundwater flow is predominantly toward the Columbia River, to the northwest. This flow is influenced by the level of the Columbia River; during the high-river stage, typically from May through August, the groundwater flow direction may become reversed. Artificial mounding caused by effluent disposal in the 199-K-2 Trench and other sites also has affected groundwater flow in the past. Evidence shows that the entire soil column was saturated during peak operating periods.

The flow rate in the 100-K Area is strongly influenced by local geohydrologic heterogeneities. Hydraulic conductivities vary from 200 m/day (656 ft/day) in local areas downgradient of the 116-K-2 Trench to 2 m/day (6.6 ft/day) in the injection well area. The range of hydraulic conductivities is a function of the degree of aquifer cementation and character of the hydrostratigraphic units.

Figure 1-2 shows that the high concentration portions of the chromium plume are downgradient of the 116-K-2 Trench. The pump-and-treat system, which has been operating since 1997, has removed approximately 285 kg (630 lbs) of chromium from the aquifer. The remedial action objective for chromium in the 100 Areas is 20 µg/L, which is based on the ambient water quality criterion (*Washington Administrative Code* [WAC] 173-201A-240[3], "Toxic Substances," "Toxic Substances Criteria") of 10 µg/L for Cr⁶⁺ and a conservative dilution ratio of 1:1. The mass of chromium remaining in the aquifer and vadose zone is unknown. The less-concentrated portion of the chromium plume has been slowly moving to the northeast, probably as a response to seasonal variations in river stage. Groundwater in the test area contains approximately 60 µg/L of Cr⁶⁺.

Two commonly employed technologies exist for treating chromium plumes in groundwater: pump-and-treat systems and in situ reduction. Pump-and-treat systems bring groundwater to the surface and remove Cr⁶⁺ from it; the treated water typically is injected back into the aquifer. Properly designed pump-and-treat systems can be effective in remediating some contaminants in some hydrogeologic settings. Specifically, contaminants that have low partition coefficients (i.e., do not readily adsorb to aquifer materials) generally are amenable to remediation by pump-and-treat systems, especially in permeable aquifers.

The reduction technology relies on establishing a reducing environment in the aquifer. This changes Cr⁶⁺ to trivalent chromium (Cr³⁺), which is readily adsorbed by soil particles, basically insoluble in groundwater under Hanford Site conditions, and much less toxic to aquatic organisms. The reducing environment can be established by installing a wall of reactant material in the aquifer (typically by digging a trench into the aquifer and filling it with iron shavings); permeating the aquifer with a strong reductant (such as was done with the in situ redox manipulation [ISRM] barrier in the Hanford Site 100-D Area); or stimulating microbes in the aquifer (either indigenous or exotic), which in turn creates a reducing environment to transform chromium, nitrate, and other reducible constituents. The 100-KR-4 treatability test described in this report used CPS in conjunction with a groundwater circulation system to reduce and fix chromium in the aquifer.

1.2 TREATMENT TECHNOLOGY DESCRIPTION

CPS is a water-soluble compound that has been shown to be a cost-effective and environmentally protective alternative in varied geohydrological regimes such as cavernous limestone in Australia; glacial outwash sand in the north-central part of the United States; and alluvial sand, silt, and clay in California (Rouse 2001, "In Situ Reduction and Geochemical Fixation of Chromium in Soils and Ground Water in Varied Geohydrological Regimes"). Cation metals such as arsenic, lead, cadmium, and copper are precipitated as non-toxic sulfides in the presence of CPS. Oxidized metals such as Cr⁶⁺ are reduced in the presence of CPS and then precipitated readily, typically as a chromium hydroxide.

Manufactured mostly for use as an agricultural soil conditioner and to prevent fungal infections in fruit trees, the National Sanitation Foundation has approved CPS for application in potable water systems. In concentrated form, polysulfide is corrosive as a result of its elevated pH, but it

is not highly alkaline in the dilute concentrations used in remedial activities. CPS is sold as an approximately 29 percent aqueous solution of CaS_x (where "x" is from 3 to 7). Commercial quantities are available from at least two manufacturers, one of which is located in Finley, Washington. Also referred to as "lime sulfur solution," it is a deep orange-red, alkaline solution with a pH between 11.3 and 11.5 and a specific gravity of 1.273.

When mixed with water, polysulfide dissociates to form the hydrogen sulfide ion or dissolved hydrogen sulfide gas, with the relative percentage a function of the solution pH. The sulfide ion then is capable of direct reduction of Cr^{6+} , as well as the reduction of ferric iron to the ferrous form, which itself is capable of reducing Cr^{6+} . Equation 1 shows a generalized equation describing the overall process:

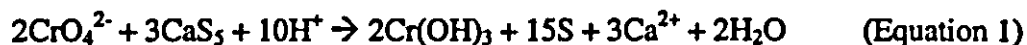

Chromium hydroxide is relatively insoluble in the neutral pH region between 7 and 9, with solubility increasing under acidic and alkaline conditions. Reducing conditions created following the addition of CPS enable reduction of other oxidized species such as Fe^{3+} to Fe^{2+} , which in turn enhances the reduction of Cr^{6+} , as shown in Equation 2:

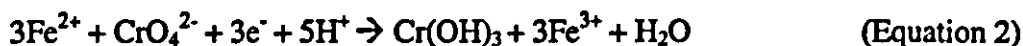

As the reactions between CaS_x and Cr^{6+} take place in groundwater, most of the sulfur precipitates as elemental sulfur, although a minor amount goes to form sulfate (SO_4^{2-}). The reduced conditions generated in the aquifer can promote the growth of sulfate-reducing bacteria (SRB) that tend to convert the native and additional sulfate ion back to hydrogen sulfide ion or hydrogen sulfide gas dissolved in the water, thereby achieving further reduction of Cr^{6+} . Nitrate ion also is reduced by polysulfide to form nitrogen gas (Jenneman and Gervertz 1999, "Identification, Characterization, and Application of Sulfide-Oxidizing Bacteria in Oil Fields, Microbial Biosystems: New Frontiers").

The formation of reducing conditions in the subsurface (Eh [soil redox potential] values in the range of -250 to -400 mV) generates conditions optimal to the growth of SRB. These organisms occur naturally in many aquifers but thrive under anaerobic, reducing conditions and convert sulfate ion into the sulfide ion (Sheldon and Rouse 2000, *Sulfate Reduction Under Natural and Enhanced Conditions*). The advantage of enhanced SRB growth, in conjunction with inorganic Cr^{6+} reduction by the application of polysulfide, is that the SRB convert ambient sulfate ion and any sulfate formed by polysulfide oxidation back into the sulfide ion, thereby getting maximum benefit from the applied sulfur, and reducing the formation of sulfate ion, which is subject to a secondary drinking water standard. While many sites contain sufficient total organic carbon to support an SRB population, active remediation projects frequently result in the depletion of the native total organic carbon concentrations, and total organic carbon needs to be added. Such addition has been in the form of molasses, corn syrup, ethanol, lactate, or virtually any available waste carbon source (e.g., whey, brewing waste). Increasingly, SRB are being used for the remediation of sulfate-bearing acid mine drainage (Van Hullebusch et al. 2004, "Examination of Chemical Speciation for Enhanced Metal Removal by Sulfate Reducing Bioreactors"; James and Tibbals 2004, "Two-Stage Biological Treatment of Acid Mine Drainage"; and Zaluski et al. 2004, "Designing Sulfate-Reducing Bacteria

Field-Reactors Using the BEST Model"). Hexavalent chromium has been treated by polysulfide at several industrial sites during the last 10 years (Blessing and Rouse 2002, "Keys to Successful In-Situ Remediation of Cr(VI) in Soil and Groundwater").

1.3 TESTING PROCEDURE

The intent of the treatability test (Chapter 3.0) was to treat chromium from an approximately 30 by 30 m (100 by 100 ft) portion of the aquifer, at the same time reducing native materials in the aquifer that would act as a permeable reactive barrier in the subsurface. To do this, four injection wells were drilled orthogonally around an existing well from which groundwater was withdrawn and mixed with CPS. This solution then was injected in approximately equal amounts to set up a circulation in the aquifer (Figure 1-3). This typically is called a "five-spot" configuration, and is ideal for a test of this type because it provides operational field experience and kinetics information in a manageable area and cleans up a section of the aquifer.

Figure 1-3. Areal Extent of Modeled Percent Concentration of Calcium Polysulfide for 100-KR-4 Treatability Test.
(Further details in Appendix A.)

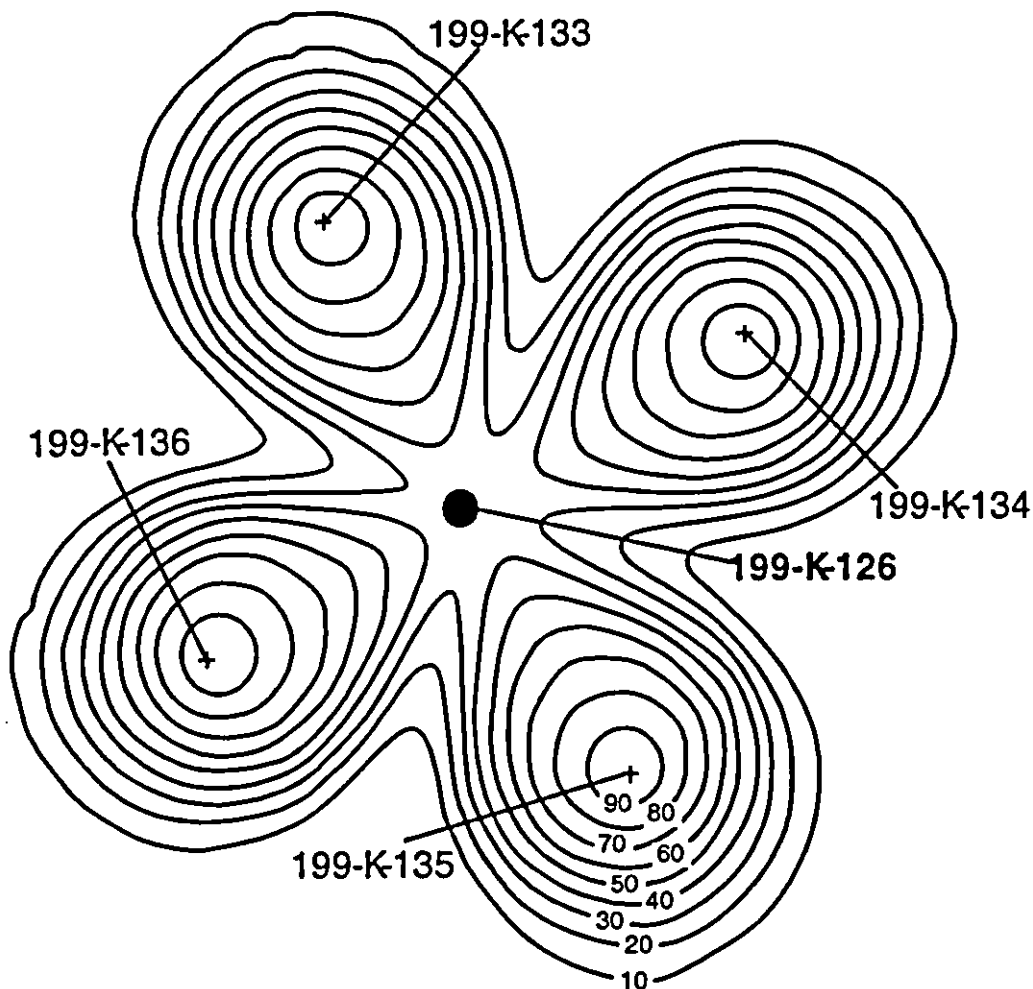

The treatability test was performed in three sequential tasks. The first task was a scoping test to determine the proper concentration of CPS to mix with the extracted water and inject into the aquifer. The second task was to design and construct the surface treatment/injection system, and the third task was to conduct the test. Details of all aspects of the test are presented in subsequent sections.

This page intentionally left blank.

2.0 CONCLUSIONS AND RECOMMENDATIONS

2.1 CONCLUSIONS

The test was conducted during the summer of 2005 for a period of 45 days. All of the performance goals were met at the end of the test. Hexavalent chromium effectively was eliminated from the treated aquifer, which was demonstrated by the lack of this contaminant in groundwater in the injection wells and extraction well. Measurements of dissolved oxygen and oxidation/reduction potential (ORP) show that the treated aquifer also was strongly reduced by the treatment; this portion of the aquifer should remain a persistent permeable reactive barrier that will treat chromium under natural groundwater flow conditions. Analysis of groundwater chemistry before, during, and after the test shows that manganese, iron, and arsenic were mobilized under the strongly reducing conditions in the aquifer, but all of these remained far below drinking water standards.

2.2 RECOMMENDATIONS

The design and equipment used in the test performed well, but some improvements could be made before using this technology again. The primary problem was precipitation of chemicals inside pipes, flowmeters, and pumps. Because of the chemical changes induced by addition of CPS, some precipitation is unavoidable. The components in the treatment system most affected by precipitation were the extraction pump and the injection pump. Sulfur accumulated on the screen of the extraction pump in well 199-K-126, which caused reduced flow and required the pump to be changed/cleaned every few days near the end of the test. The injection pump needed to be manually adjusted frequently because calcium carbonate precipitated on its impeller, causing extra internal friction. Both phenomena acted to decrease pumping efficiency. Subsequent tests should consider using a jet pump or similar technology that would not be seriously influenced by precipitation.

The type of carbon used to augment reduction in the aquifer also could be improved. During this test, a proprietary emulsified vegetable oil was injected into the aquifer, but tended to separate and coat the piping and flowmeters with a semi-solid grease. A number of other carbon sources would not cause similar problems, and these should be investigated, along with the need to add carbon, if this technology is used again.

The process may be simplified in future applications by eliminating the mixing tank and injecting CPS directly into the injection wells. The primary purpose of the tank was to separate precipitate from the treated groundwater, but very little precipitation occurred. Using this approach virtually would eliminate a waste stream and the added expense and handling complications. Because the amount of precipitate will vary with groundwater chemistry, deploying this technology in a different area will require some testing to determine the amount of precipitate before deciding if a mixing tank is a necessary part of the treatment system.

This test is considered successful because chromium was removed from the groundwater and the aquifer was reduced. Both were accomplished significantly faster than predicted. The data

collected are sufficient to scale up the treatment technology and incorporate equipment modifications to increase efficiency.

Two factors that have not been evaluated in this test should be considered in future deployments on the Hanford Site. One factor is the potential effects of oxygen-deficient groundwater on organisms in the Columbia River. Groundwater beneath the test area should at least partially reoxidize by mixing with untreated groundwater before it reaches the river, but deploying this technology too close to the river may result in anoxic conditions in the riverbed, which could affect biota in the river. The aquifer near the test area will continue to be monitored for oxygen content and other selected constituents, specifically in well 199-K-130, located between the test area and the Columbia River.

The other factor that needs to be evaluated on a site-specific basis is mobility of constituents in the aquifer, specifically radionuclides. It is unlikely that any of the radionuclides occurring in the 100 Areas would be mobilized under reducing conditions. Near the river, uranium, Tc-99, and Sr-90 are the three radionuclides that might be present in the aquifer above regulatory limits. Uranium and technetium are less mobile under reducing conditions, so would not mobilize during treatment with CPS. Strontium-90 is not sensitive to oxidation-reduction or pH changes, so would be unaffected under the influence of this treatment technology.

2.3 EVALUATION WITH RESPECT TO CERCLA CRITERIA

This section provides a summary of the performance of CPS treatment technology with respect to the *Comprehensive Environmental Response, Compensation, and Liability Act of 1980* (CERCLA) evaluation criteria.

2.3.1 Threshold Criteria

2.3.1.1 Overall Protection of Human Health and the Environment

This technology has proved that it can reduce the concentration of Cr^{6+} in the groundwater to levels well below the drinking water standard and the freshwater ambient water quality criterion. In the process of doing this, dissolved oxygen is depleted from groundwater and some metals in the aquifer can be mobilized. If these conditions are allowed to affect the Columbia River, they may adversely impact aquatic life. This concern mandates that future deployments of the technology should be significantly far away from the river to minimize the potential for adverse impacts, or that further study of these conditions be assessed to establish any additional controls needed for future deployments.

2.3.1.2 Compliance with Applicable or Relevant and Appropriate Requirements

Groundwater quality within the test zone has achieved compliance with all primary drinking water standards and has effectively reduced the concentration of chromium to below the freshwater chronic toxicity criteria. Sulfate concentrations within this zone are likely to exceed the secondary drinking water standard. The metals manganese and arsenic were mobilized

during the test and may represent a concern for aquatic species. Further evaluation of these and other trace metals may be necessary.

2.3.2 Balancing Criteria

2.3.2.1 Long-Term Effectiveness and Permanence

Because of the short-term nature of the test, the degree to which the permanence can be established is uncertain. The longevity of the chemical conditions and continued effectiveness of groundwater treatment within the zone continue to be monitored to assess permanence.

2.3.2.2 Reduction of Toxicity, Mobility, or Volume through Treatment

Treatment of groundwater by CPS reduces the toxicity, mobility, and volume of chromium by treating the groundwater as an ex situ treatment as well as in situ treatment by reducing Cr^{6+} to Cr^{3+} in the aquifer.

2.3.2.3 Short-Term Effectiveness

Treatment by CPS meets the short-term effectiveness in that the application reduces the chromium concentration to below 20 $\mu\text{g/L}$ upon contact. This technology is not expected to present a significant increased risk to the community.

2.3.2.4 Implementability

This technology is easily implementable for the following reasons.

- It does not require difficult construction and operation activities.
- The chemical can be readily obtained locally.
- The effectiveness of the treatment can be monitored readily from existing monitoring wells.
- Maintenance costs are expected to be low.

2.3.2.5 Costs

The treatability study can help provide the data necessary for equipment scaleup. The cost to plan, design, construct, conduct, and evaluate the treatability test in the 100-KR-4 OU is approximately \$930,000.

This page intentionally left blank.

3.0 TREATABILITY STUDY APPROACH

The test was performed to evaluate the effectiveness of using CPS to remove Cr^{6+} from the groundwater at the test area, estimate the cost of deploying this technology, and obtain the data needed to design a larger remediation system. Before the test was performed, a data quality objectives workshop was conducted to determine the data requirements needed to verify the effectiveness of Cr^{6+} removal from the groundwater and to ascertain any unacceptable secondary impacts on groundwater from the treatment process. Details of the data quality objectives workshop can be found in DOE/RL-2005-05.

3.1 TEST OBJECTIVES AND RATIONALE

The objectives of the test were as follows.

- Verify the ability to achieve in situ chromium reduction using an active remediation system involving CPS and a carbon source, which together reduce the groundwater and aquifer by inorganic and microbiological processes.
- Determine if other species such as manganese or arsenic are mobilized as a result of this reduction, and how other parameters such as nitrate or dissolved oxygen are affected as a result of the groundwater treatment.
- Obtain operational experience in the treatment of chromium-contaminated groundwater by the use of CPS as the reducing medium.

As mentioned in Chapter 1.0, chemical reduction of the aquifer has been used elsewhere on the Hanford Site to treat chromium contamination. The ISRM barrier was installed in the 100-D Area between 1997 and 2002 by injecting sodium dithionite, a strong reductant, into the aquifer through a linearly arranged series of 66 boreholes. The sodium dithionite acts to reduce oxidized materials in the aquifer (predominantly changing ferric iron to ferrous), which in turn will reduce Cr^{6+} to Cr^{3+} as contaminated groundwater flows through the treated area. The ISRM barrier has been effective in treating the targeted chromium plume, but some portions of the barrier have shown signs of failure as soon as 2 years after emplacement, far short of the predicted 20-year lifespan of the barrier. To address this issue a panel of outside experts was invited to the site to suggest ways to "mend" the ISRM barrier. One of the suggestions contained in their report (WMP-28124, *Evaluation of Amendments for Mending the ISRM Barrier*) was to use CPS instead of sodium dithionite to remediate the chromium plume. The advantages to this approach are as follows.

- CPS has been demonstrated to be highly effective in rapidly reducing Cr^{6+} (Blessing and Rouse 2002) at industrial sites throughout the United States and Australia.
- This approach is capable of reducing NO_3 to N_2 gas and reducing dissolved oxygen, creating a reducing environment in the aquifer that will act as a permeable reactive barrier.

- CPS is more stable than dithionite, so it has the potential to create a larger reactive zone downstream of the injection wells.
- Relatively little CPS is needed to achieve reduction of Cr^{6+} concentrations to less than $10 \mu\text{g/L}$, commonly 1 to 3 percent of the 29 percent stock solution. CPS also is less costly and easier to manage than dithionite.

3.2 EXPERIMENTAL DESIGN AND PROCEDURE

This section will detail the laboratory tests performed to determine the effects of CPS on the groundwater, which also established the optimum concentration to introduce into the aquifer, and the design and performance of the field test.

3.2.1 Scoping Tests

In the middle of March 2005, a series of scoping tests were conducted on a bulk sample of groundwater obtained from well 199-K-126. This water was collected the morning the tests began, in four 5-gal (19-L) flexible containers. To closely maintain aquifer conditions after collection, the temperature and redox conditions were maintained during the course of the tests, the latter parameter accomplished by limiting headspace in the containers as water was withdrawn. This groundwater was analyzed to establish its baseline chemistry (see Section 4.1.2). The tests were conducted by mixing groundwater and CPS, then observing the solutions for physical changes, measuring field parameters and fundamental chemical properties, and sending subsamples to a fixed laboratory for analysis.

To determine the range of CPS concentrations needed to achieve proper reducing conditions, nine groundwater samples were reacted with varying doses of CPS in 100 mL beakers. Visual observations were made on the samples approximately 1 hour after dosing, and measurement of the sample's ORP was recorded after approximately 2 hours. The ORP meter was not calibrated correctly so these results only can be used to evaluate relative ORP. Color of the solution is a good guide to the geochemistry, where a clear orange indicates presence of polysulfide along with an elevated pH and a strongly reducing environment; a yellow cloudy solution results from precipitation of sulfur in a slightly lower pH and reducing conditions. A green solution is indicative of Cr^{3+} without excess CPS and thus only mildly reducing conditions. From these experiments it was determined that between 5 and 10 percent (of the 29 percent CPS concentrate) should be used during the treatability test, with the goal of approximately 7 percent.

After obtaining these results, Imhoff flasks containing 1 L of groundwater were dosed with 30, 60, 120, and 150 mL (3 to 15 percent) of CPS and allowed to react. This was done primarily to estimate the amount of precipitate that would be generated during the treatability test. These flasks, which are cone-shaped to allow an accurate measurement of settled material, were observed for approximately 2 hours. The results, presented in Table 3-1, show that only about 0.02 percent of the volume of reacted water is expected to precipitate.

Table 3-1. Data from Field Scoping Tests.

Calcium Polysulfide Dose, mL/L	Relative ORP, mV	Density	Remarks, 1-Hour Observations
0	+150.7	NM	Untreated groundwater
0.5	+73.7	NM	Almost colorless, turbid
1.0	+65.4	NM	Greenish yellow, turbid
2.0	+69.2	NM	Yellow, turbid
3.0	+67.0	NM	Yellow, turbid
5.0	+62.5	NM	Yellow/orange, turbid
10 (1%)	+47.3	NM	Orange, turbid, sulfur layer on surface
15 (1.5%)	+36.6	NM	Orange, slightly turbid
30 (3%)	-0.3/-0.3	1.010	Orange, clear, duplicate ORP readings, settleable solids 0.2 mL/L
50 (5%)	-18.3/-17.9	NM	Orange, clear, duplicate ORP readings
60 (6%)	-22.7	1.016	Settleable solids 0.2 mL/L
120 (12%)	-40.6	1.030	Settleable solids 0.1 mL/L
150 (15%)	-45.0	1.035	Settleable solids 0.05 mL/L

NM = not measured.

ORP = oxidation/reduction potential.

These tests show that CPS doses less than approximately 15 mL/L (1.5 percent, or 15 ppm) result in the dissociation of the polysulfide into hydrogen sulfide ion, which reacts with chromium and nitrate to form a suspension of elemental sulfur in the water; hence the turbidity and yellow color. As discussed in the operational narrative in Section 3.2.2.3, this is an important phenomenon to account for when designing and operating a polysulfide-based remediation system. By contrast, dose rates of 30 mL/L (3 percent) or more tend to remain largely as polysulfide (hence the orange color), with little sulfur in suspension. It is advantageous to add more than 3 percent CPS so the dissociation into the hydrogen sulfide ion takes place in the subsurface beyond the injection wells, when the solution mixes with groundwater and the pH drops. Sulfur then is formed in the aquifer and not on the surface where it can clog the injection/mixing system.

Figure 3-1 illustrates the relationship between CPS concentration and ORP in the groundwater. At low concentrations, an increase of CPS results in a nearly linear decrease of ORP. This decrease is moderated at concentrations close to 3 percent and the ORP becomes negative. This is the point at which CPS begins reducing Cr^{6+} and nitrate, having essentially depleted dissolved oxygen on the water. Experience has found that dose rates greater than 3 percent yield less precipitate, which also settles into a more discrete solid mass, in comparison to the more flocculent solids that form at lower dose rates. The solution density also is plotted in Figure 3-1, and shows the expected increase of density with CPS concentration.

Figure 3-1. Density and Oxidation/Reduction Potential as a Function of Polysulfide Dose.

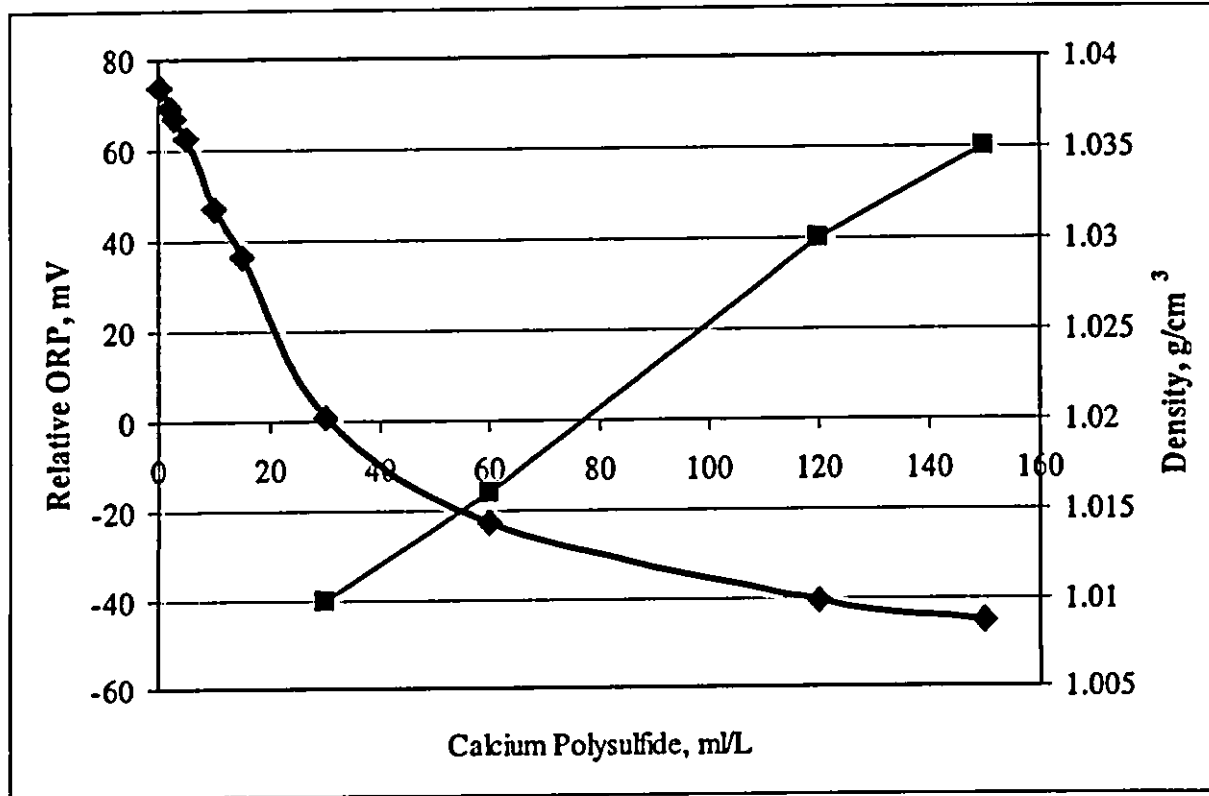

The dose rate of polysulfide is a balance of sufficient polysulfide strength to achieve reduction, not only in the surface treatment system but also in the subsurface, without forming a dense solution or consuming too much reductant. Based on the scoping tests, a dose rate of between 5 and 10 percent (of the 29 percent CPS concentrate) was planned, with the goal of approximately 7 percent (70 mL/L).

3.2.2 Field Test

This section details the work involved in planning and constructing the boreholes and designing the system for treating groundwater and injecting it into the aquifer.

3.2.2.1 Well Configuration

The physical center of the 100-KR-4 OU treatability test is well 199-K-126. This well was constructed in 1999, and used as an extraction well for the 100-KR-4 pump-and-treat system from January 2003 to February 2005. Constructed with 4-in. stainless steel casing and a 0.020-in. slot wire-wrapped screen, the well penetrates approximately 15 ft (4.6 m) into the aquifer (from 70 to 84 ft [21 to 26 m] below ground surface). For the test, an extraction pump (Grundfos submersible) was installed approximately 10 ft (3 m) below the groundwater table, and connected to the surface with a 2-in. stainless steel pipe.

The four injection wells were constructed in April and May 2005, using Becker hammer drilling technology to install 6-in. stainless steel casing and 0.090-in. slot wire-wrapped screen; the

annulus around the screen was packed with 4-8 mesh Colorado silica sand. The screened intervals were approximately 64 to 94 ft (20 to 29) below ground surface, penetrating the upper two-thirds of the Ringold Formation (Unit E). The Ringold Upper Mud is approximately 113 ft (34 m) below ground surface in this area. Pertinent details on the wells are in Table 3-2; further details can be found in WMP-27726, *Borehole Summary Report for Wells 199-K-133, 199-K-134, 199-K-135, and 199-K-136, FY 2005*.

The injection wells were configured to be upgradient and downgradient (199-K-135 and 199-K-133, respectively) of the extraction well, and lateral of the extraction well with respect to groundwater flow. A map of the wells is shown in Figure 3-2. The injection wells were plumbed with 1-in. polyvinyl chloride pipe with two ¼-in. (0.64 cm) holes drilled every 6 in. (15 cm) along the bottom 20 ft (6 m) of the pipes. This was done to minimize exit velocity in the screened area so that the injected water would not damage the sand pack and formation. If this happened, sand and formation material would enter and fill in the well.

3.2.2.2 Treatment System Design

The treatment system used a 5,500-gal (21,000 L) conical tank (Figure 3-3) to mix extracted water with CPS, and a system of metering pumps and valves to treat the water and regulate flow into the injection wells. A site layout of the system is presented in Figure 3-4.

The system was designed to operate by pumping water into the reaction tank from well 199-K-126 and mixing it with the appropriate amount of CPS. This solution would have a minimum residence time of 2 hours to allow precipitate to form and settle, then would be drawn off the upper part of the tank through a pump mounted on the treatment skid. This pressurized flow then would be forced through a filter, mixed with the organic substrate, and distributed to the injection wells, where the flow to each well would be manually regulated by valves through the use of flowmeters. Specific components of the treatability system were as follows:

- Electronic controls to manually set the pumping rate on the extraction pump, CPS metering pump, and organic substrate metering pump
- Electronic controls to automatically adjust the pumping rate on the solution injection pump to maintain the appropriate level in the 5,500-gal mixing tank
- A transducer in the extraction well to measure the amount of drawdown
- A transducer in the mixing tank to measure the depth of solution in the tank and provide feedback for controlling the injection pump speed, calibrated in gallons
- An electronic system to shut down the treatment system if the level in the tank became too low or too high
- Leak detection sensors to shut down the system if spillage into the tank containment berm or injection skid was detected during operation
- A number of flowmeters and pressure gauges to monitor conditions during operation.

Table 3-2. Well Construction Summary.

Well Name	Well ID	Total Depth Drilled (ft bgs)	Water Level (ft bgs)	Permanent 4-in. Diameter Screen and Casing ^a				Top of 6-in. Diameter Protective Casing	Borehole Backfill	Sandpack ^c Interval (ft bgs)	Seal ^{d,e} (ft bgs)	Grout Depth (ft bgs)	
				Top of Screen (ft bgs)	Bottom of Screen (ft bgs)	Screen Length (ft)	Sump (ft)						Top of Casing (ft)
199-K-133	C4734	99	67.8	63.6	93.7 ^a	30.1	3.0	+2.2 ^g	+1.6	None	58.0-97.5 ^e	11.0-52.7 ^d 52.7-58.0 ^e	11.0-0 ^f
199-K-134	C4735	99	69.8	64.4	94.5 ^a	30.1	3.0	+1.6 ^g	+1.6	None	59.4-98.25 ^e	9.1-53.2 ^d 53.2-59.4 ^e	9.1-0 ^f
199-K-135	C4736	113.4	69.2	64.4	94.5 ^a	30.1	3.0	+2.4 ^g	+1.9	105.75-113.4 ^b	59.5-100.55 ^e	9.0-54.5 ^d 54.5-59.5 ^e 100.55-105.75 ^e	9.0-0 ^f
199-K-136	C4737	104	68.5	64.0	94.0 ^a	30.0	3.0	+2.0 ^g	+2.0	96.5-104.0 ^b	59.1-96.5 ^e	10.3-55.3 ^d 55.3-59.1 ^e	10.3-0 ^f

^a0.090-in. slot opening.^b10-20 mesh Colorado silica sand.^c4-8 mesh Colorado silica sand.^dBentonite crumbles.^e0.25-in. bentonite pellets.^fPortland Cement.^gType 316L Schedule 5 stainless steel.

bgs = below ground surface.

ID = identification.

Figure 3-2. Map of Wells Used for the 100-KR-4 Treatability Test.

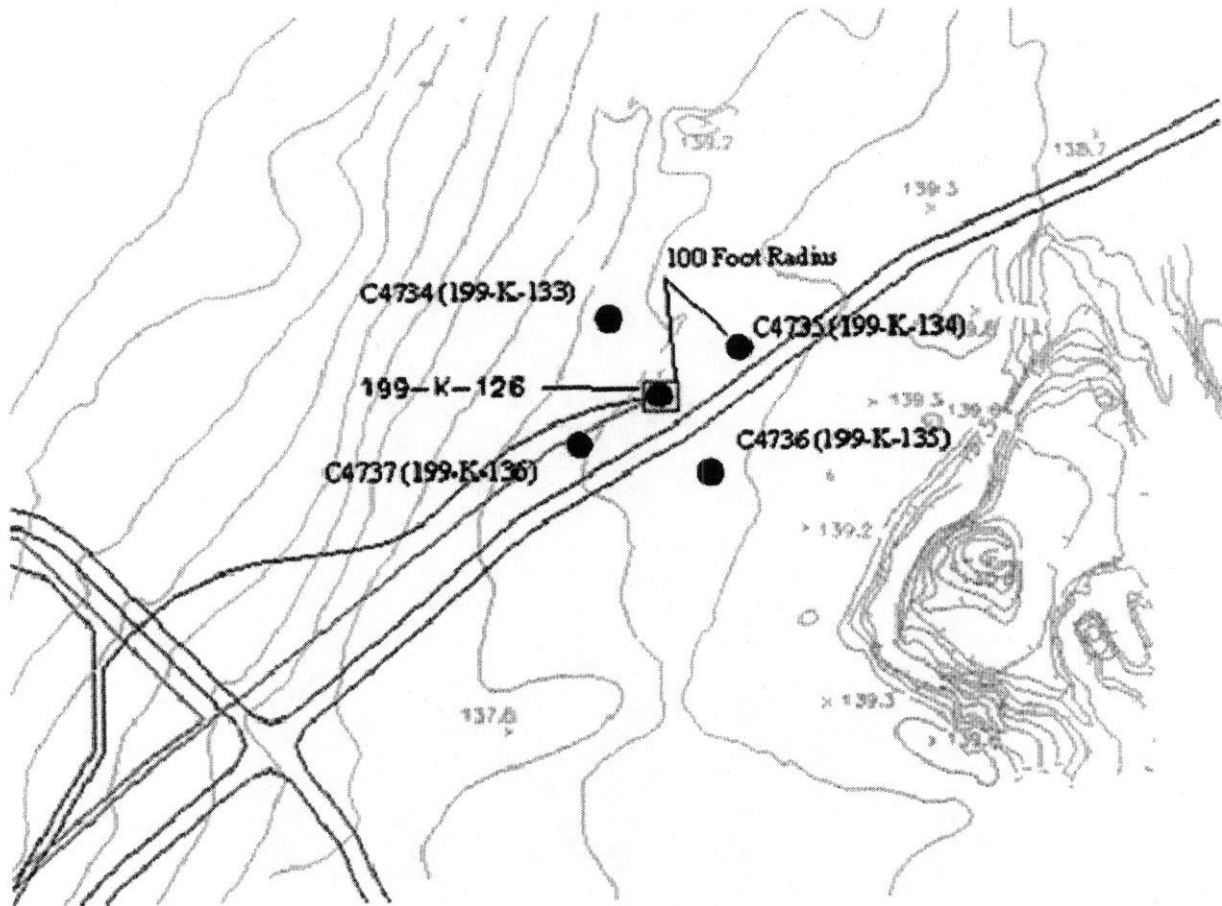

Figure 3-3. Reaction Tank used in the Treatability Test.
The reacted solution was withdrawn from the tank at approximately two-thirds capacity through the 2-in. pipe.

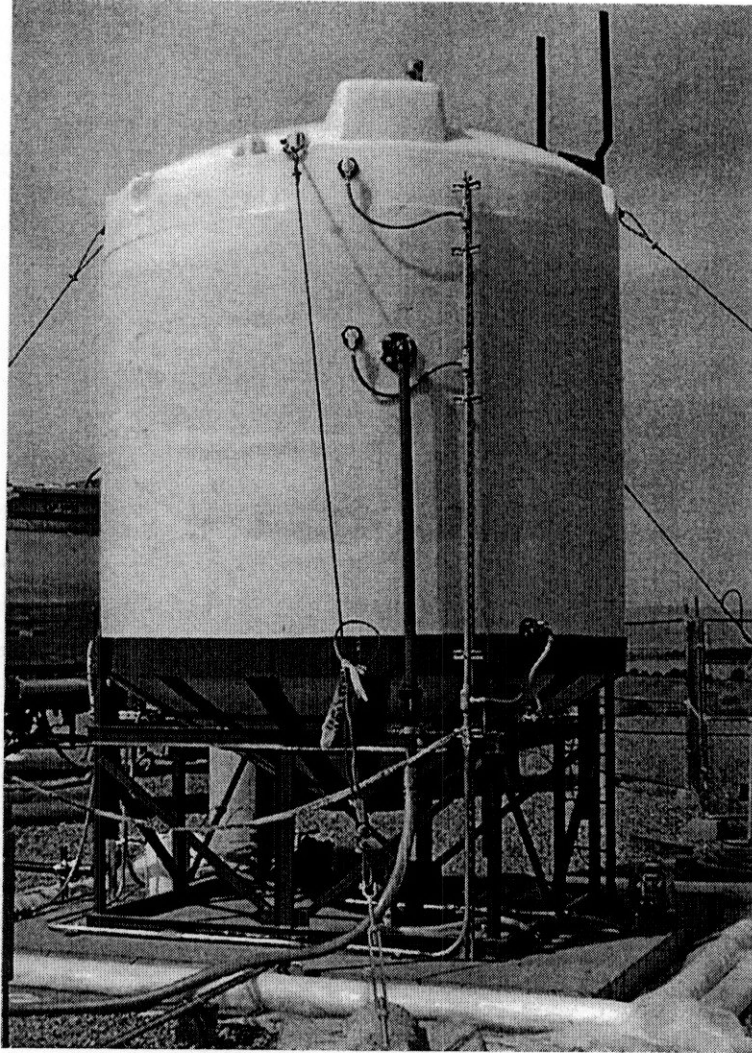
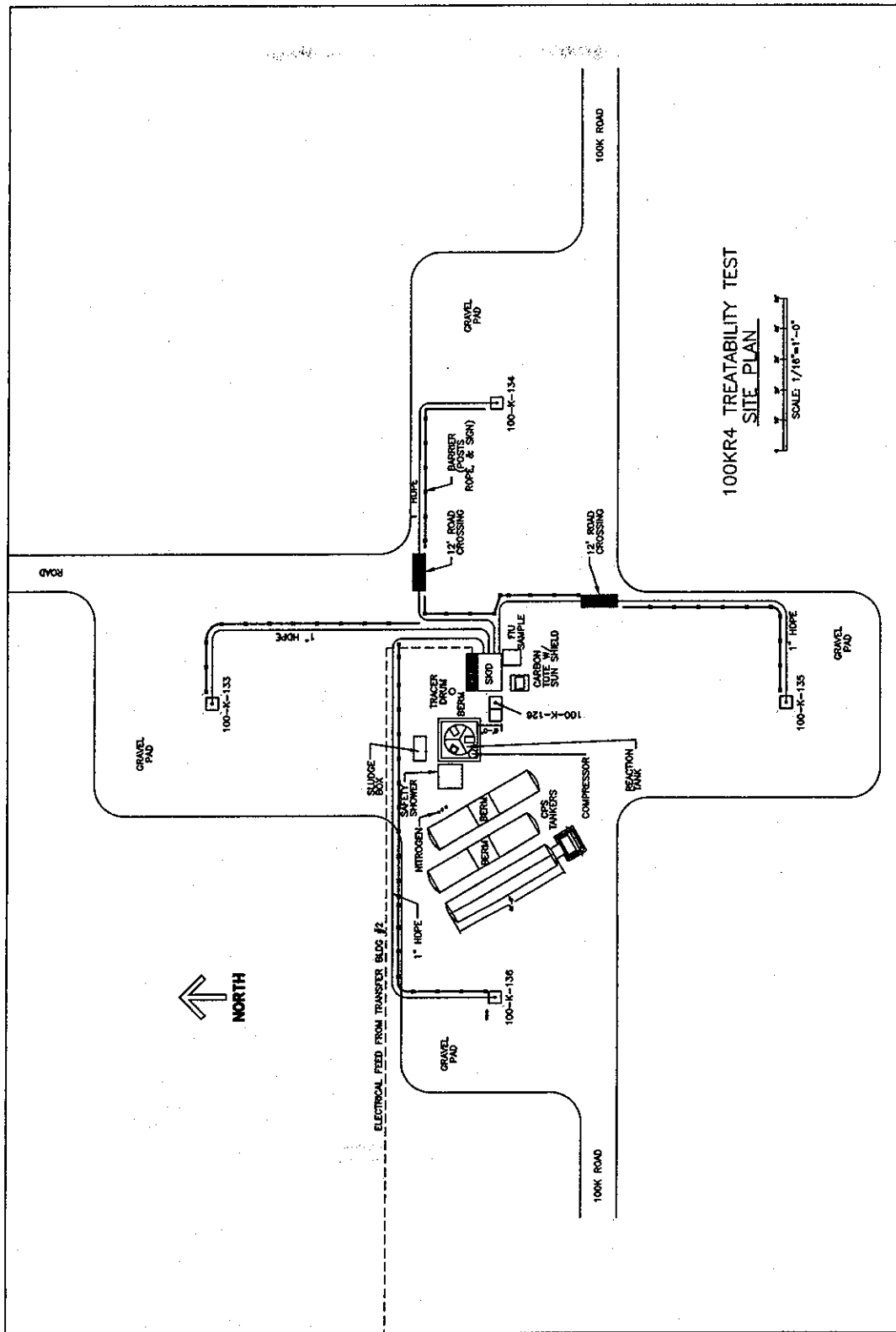

Figure 3-4. Site Plan for the Treatability Test System.



In anticipation of a significant volume of precipitation collecting in the bottom of the conical mixing tank (approximately 100 gal (380 L) , based on the scoping study), a diaphragm pump and associated plumbing were installed to remove these solids. Metering pumps also were installed to inject precise amounts of CPS into the mixing tank and an emulsified vegetable oil into the injection manifold. The latter chemical was used to promote the activity of indigenous SRB in the aquifer (see discussion in Section 1.2).

An engineering drawing and photograph of the skid, onto which most of the pumps and valving were mounted, are presented in Figures 3-5 and 3-6, respectively.

3.2.2.3 Treatment System Operation

The treatability test began operation on June 28, 2005, in compliance with Tri-Party Agreement Milestone M-016-28B, which had a due date of July 1, 2005. Before startup, systems were tested for leaks and proper operation, and a tracer study was initiated. Water was circulated without CPS on June 27, when a lithium bromide tracer was injected into well 100-K-134. This tracer test, along with slug tests carried out in the extraction well and injection wells before and after the treatability test, was conducted to quantify the hydraulic conductivity in the aquifer beneath the treatability test area. A recording bromide sensor was installed to monitor groundwater from the extraction well and collect data during the initial treatment period. Discrete water samples also were collected and analyzed for bromide. Details on the tracer and slug tests are provided in Appendix A.

The system was designed to operate by manually setting the extraction rate and having the injection pump vary the rate of injection to automatically maintain the level in the mixing tank. During the first week of operation, it became clear that the hydraulic head produced by the tank was sufficient to supply the injection wells. The automatically controlled injection pump slowed down and then stopped completely when the tank reached a certain level. Under these conditions, with only gravity driving the injections, often one well would lose flow (due to higher friction losses caused by pipe routing) and the others would increase to match the extraction well flow. This allowed calcium carbonate to precipitate in the pump, which led to failure when the pump was restarted. After this was discovered, the injection pump controls were modified to keep the pump rotating at a minimum speed when the wells were being injected. The pump operated with no further problems for the remainder of the test.

The test skid filters (Figure 3-6), used to keep precipitate from clogging the injection well screen, were changed twice during the test. The first was shortly after the test began, because the groundwater initially was being mixed with CPS. As observed in the laboratory scoping tests (Section 3.2.1), low concentrations of CPS in water produce a sulfur precipitate; this formed as groundwater in the mixing tank was being injected with the polysulfide and subsequently was trapped in the filters. Once the concentration of CPS reached 5 to 7 percent there was no precipitate found in the filters during operation. The second time the filters trapped material was during final shutdown of the system, when polysulfide was diluted in preparation for tank cleanout.

Figure 3.5. Schematic Drawing of the Treatability Test Skid.

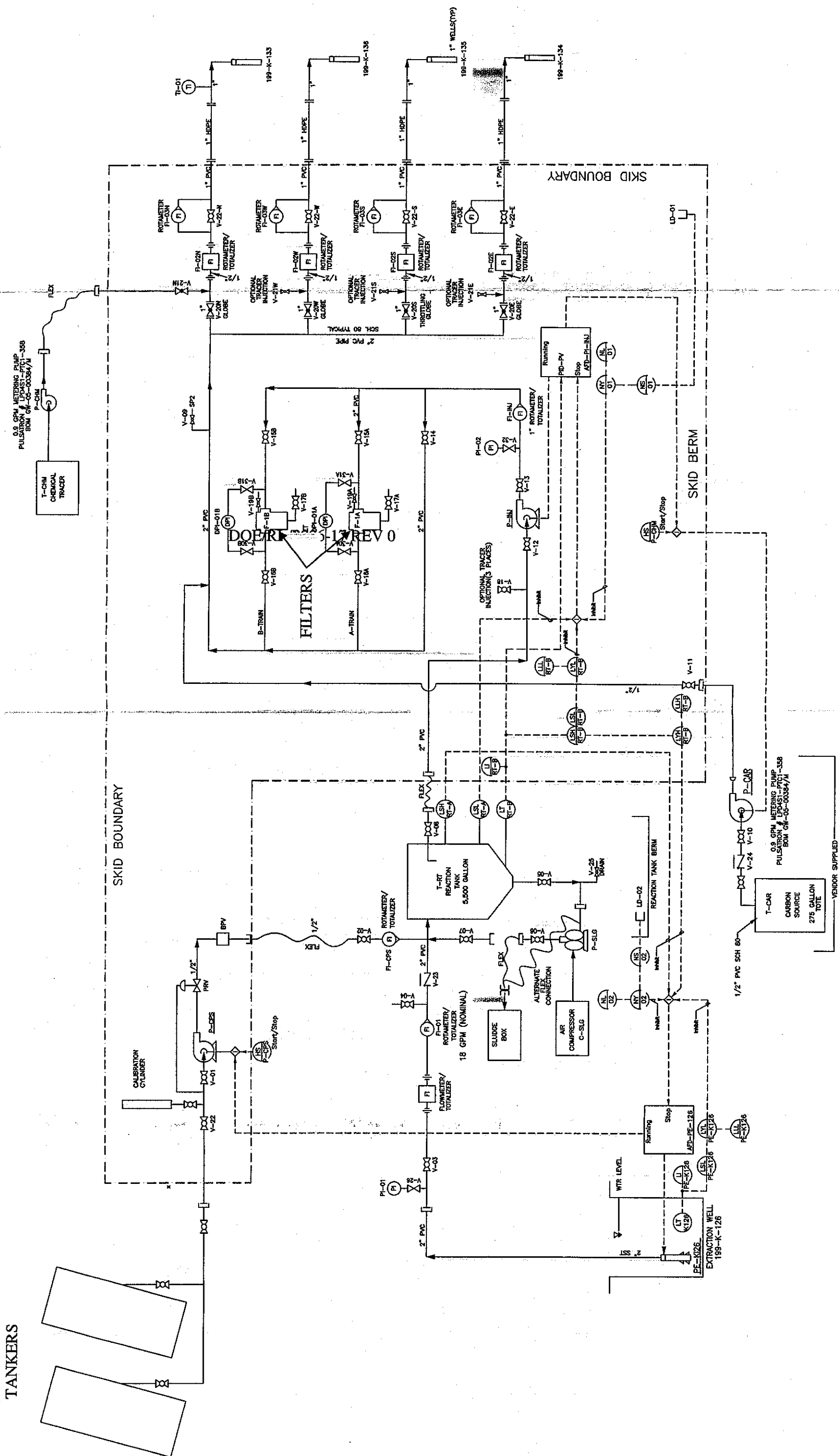

TANKERS

Figure 3-6. Treatability Test Skid Before Piping was Connected. Treated groundwater from the tank entered the skid on the left side and was distributed to the four injection wells via valving on the right side. View is to the northwest.

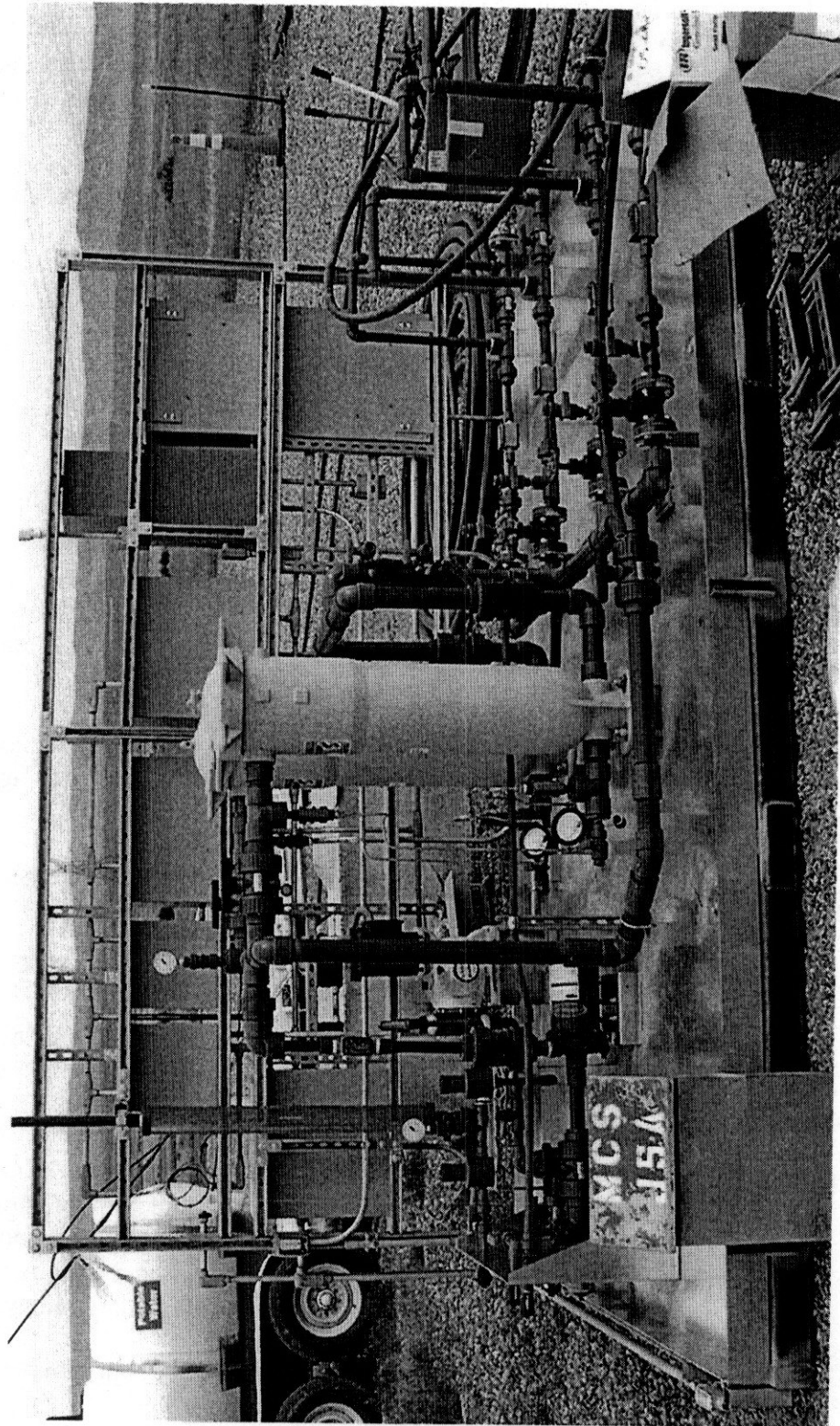

Near the end of the test, the system was shut down over weekends because the extraction pump experienced a loss of efficiency during the course of the week. This happened after the treated water reached the extraction well and sulfur began coating the intake screen. When the pump was disassembled, it was discovered that the interior also was plugged with sulfur, which had the consistency of toothpaste. The screen and impeller stages were pressure washed with water, which removed the substance, then reassembled and placed back in service.

Samples of precipitates in the injection and extraction pumps were collected and analyzed; information from these analyses is discussed in Section 4.1.2.

3.2.2.4 Treatment System Key Operation Dates

<u>Day</u>	<u>Date</u>	<u>Event description</u>
Tuesday	6-21-05	Started fill of reaction tank.
Thursday	6-23-05	Test skid located at test site; initial electrical testing started.
Friday	6-24-05	First tanker of "Calmet" CPS arrived at test site.
Monday	6-27-05	First integrated operation of test skid and completion of acceptance testing. 10:30 a.m. started injecting ~500 gal (130 gal) of lithium bromide tracer into well 199-K-135, completed at 11:10 a.m.
Tuesday	6-28-05	08:00 started CPS injection to reaction tank and four injection wells. 15:30 running in auto mode; carbon source injection running. Left system running overnight unattended.
Wednesday	6-29-05	Installed backup manual rotometers on four injection wells to add redundant flow indication to turbine meters.
Thursday	6-30-05	Second CPS tanker staged on site and hooked in.
Friday	7-1-05	Pumped from bottom of reaction tank to remove any precipitate/sludge from conical bottom. None accumulated. Discharge water crystal clear to golden yellow.
Sunday	7-3-05	Manual rotometers on injection wells appear to have oil sludge building up. Secured carbon source injection. First injection line turbine meter stopped working. Adjusted CPS metering pump to 5 percent dosing. Reaction tank concentration ~12 percent. Secured system for holiday, because there is insufficient CPS to run through the holiday.
Tuesday	7-5-05	Started system back up. Injection pump seized, but gravity/siphoning allows system to continue to run.
Wednesday	7-6-05	Reaction tank level transmitter flange started leaking. Drained tank to fix flange leak. System down until 7/12/05 for parts.

- Tuesday 7-12-05 Refilled reaction tank and maintained CPS flow to match well water flow, ~6.2 percent CPS concentration. Replaced injection pump and placed back in service.
- Wednesday 7-13-05 Second turbine meter stopped working; observed plating on rotometer glass surface.
- Thursday 7-14-05 Verified no sludge from bottom of reaction tank to waste box. When taking bromide sample of extraction well water noticed greenish tint to water when observed in white 5-gal bucket. Extraction well 199-K-126 pump flow has been decreasing. System shut down. Chromium sample from well 199-K-126 is less than detection.
- Monday 7-18-05 Chromium sample from well 199-K-126 at 5 ppb.
- Wednesday 7-20-05 Pulled and replaced well 199-K-126 pump. Cleaned and replaced injection pump. System back up and running in automatic. Chromium samples from well 199-K-126 are 9 and 11 ppb.
- Thursday 7-21-05 Removed turbine meters and spooled through because all four had stopped working. Verified reaction tank bottom flow still clear with no sludge.
- Friday 7-22-05 Secured system at end of day. Chromium sample from well 199-K-126 back to less than detectable.
- Monday 7-25-05 Secured system at end of day to change out well pump next day.
- Tuesday 7-26-05 Swapped extraction well pump. New well pump is 3 hp. Removed pump suction strainer covered with sludge.
- Wednesday 7-27-05 New pump dropped 10 gal/min overnight. Secured system to evaluate pump replacement. Chromium sample from well 199-K-126 is less than detectable.
- Monday 8-8-05 Started system back up.
- Tuesday 8-9-05 Extraction flow dropped overnight. Flow dropped during day; secured at end of day shift.
- Wednesday 8-10-05 Started extraction well pump to take samples at 50-, 100-, and 500-gal pump to evaluate securing test.
- Thursday 8-11-05 Changed out extraction well pump; pumped for 3 hours, then secured.
- Monday 8-15-05 Lined up to drain reaction tank. Test to be secured.

3.2.3 Equipment and Materials

The following is a summary of equipment used during the test.

- Tanker staging area:
 - Two tankers with a capacity of ~6,000 gal (23,000 L) each of CPS. The tankers were refilled by the chemical vendor with a third tanker and a tractor. CPS was pumped from the supply tanker to either of the staged tankers as required.
 - Valves and hoses with camlock fittings to route the CPS as required.
- Waste staging area:
 - 55-gal waste drums
 - 4- by 4- by 8-ft lined waste box for liquid waste (sample water and liquid chemical waste)
- Reaction tank area (see Figure 3-3):
 - 5,500-gal conical bottom reaction/mixing tank and stand on a 6-in. concrete pad with a leak containment berm
 - Electrical air compressor to drive the sludge diaphragm pump
 - Air-driven diaphragm pump to recirculate the reaction tank liquid and pump sludge from the tank bottom to a 4- by 4- by 8-ft lined waste box
 - Valves and hoses with camlock fittings to route the CPS as required
 - Turbine flowmeter (totalized and actual flow) for extraction water
 - Magnetic flowmeter (totalized and actual flow) for extraction water
 - Turbine flowmeter (totalized and actual flow) for CPS injection
 - Level transmitter for reaction tank level
 - Two float switches for reaction tank level trip
 - Leak detection sensor in berm area

- Safety shower trailer
- Treatability test skid (see Figure 3-5):
 - Control panels: Power distribution, pump adjustable-frequency drive control, and level indication
 - CPS meter pump and control piping
 - Injection pump and valving
 - Dual bag filter housing and pressure gauges
 - Turbine flowmeter for injection flow
 - Carbon source metering pump
 - Manual throttle valves for the four injection well lines
 - Turbine flowmeters for the four injection well lines
 - Backup manual rotometers for the four injection well lines
 - Leak detection sensor inside the skid containment tray
- Carbon source tote
- Extraction well 199-K-126:
 - Submerged groundwater pump/motor
 - Well level sensor/transmitter
- Injection wells (four):
 - Sealed piping to inject the treated water below groundwater level
 - Pressure gauge and temperature indication on representative well.

3.3 SAMPLING AND ANALYSIS

The goals of sampling were to collect enough data at sufficient quality to evaluate the hydrologic characteristics of the affected aquifer and assess the efficacy of treating the groundwater and aquifer with CPS.

The sampling and analysis performed during the course of the treatability test were guided by DOE/RL-2005-05 and by the sampling and analysis plan in its appendix. Post-treatment monitoring to evaluate the persistence of aquifer reduction and any deleterious effects that may

arise from the treatment process also was conducted; the sampling schedule is summarized in Table 3-3.

Table 3-3. Sampling Schedule for 100-KR-4 Treatability Test Monitoring.

Well Number	Begin/End Sampling	Field Analysis for pH, Cr ⁶⁺ , Nitrate, Conductivity, ORP	Laboratory Analysis for Metals and Anions ^a
199-K-135 (injection well upgradient of 199-K-126)	After treatment ends/6 months after Cr ⁶⁺ breakthrough ^b	Every 2 weeks	Monthly
199-K-126 (extraction well)	After treatment ends/6 months after Cr ⁶⁺ breakthrough	Every 2 weeks	Monthly
199-K-133 (injection well downgradient of 199-K-126)	After breakthrough in 199-K-126/6 months after Cr ⁶⁺ breakthrough in this well	Monthly	Monthly
199-K-130 (monitoring well ~400 m downgradient of 199-K-126)	2 weeks after breakthrough in 199-K-133/6 months after Cr ⁶⁺ breakthrough	Monthly	Monthly after ORP drops in well

^aSpecific metals and anions are specified in Table 2 of DOE/RL-2005-05, *Treatability Test Plan for Fixation of Chromium in the Groundwater at 100-K*.

^bBreakthrough is defined as detection of Cr⁶⁺ in the well.

ORP = oxidation/reduction potential.

3.3.1 Hydrologic Properties

The hydrologic characteristics of the aquifer were evaluated by conducting slug tests on the extraction well and four injection wells before and after the treatability test, and a tracer test in conjunction with the treatability test. Only injection slug tests were performed on the injection wells, because the coarse screen/pack used for construction of these wells might have been degraded with a slug withdrawal test. Injection and extraction slug tests were performed on the extraction well. Slug test stresses in the well were produced by rapidly submerging (slug injection) or withdrawing (slug withdrawal) various-sized slugging rods of known volumetric displacement. At all test sites, two different sizes of slugging rods were used to impart varying stress levels for individual slug tests. The slug tests were repeated at each stress level to assess reproducibility of the test results. Further details on these tests are contained in Appendix A, and the results are summarized in Section 4.1.1.

Lithium bromide was injected into well 199-K-135 at the beginning of the treatability test. Approximately 450 gal (1,700 L) of bromide solution at a concentration of 1,420 mg/L was injected over a 1-hour period. Water from the extraction well was analyzed with a solid-state bromide probe connected to automated recording equipment. Bromide was detected with this system approximately 32 hours after injection. The goal was to monitor bromide in the extraction well for up to a month, which would yield a complete arrival curve and allow an accurate assessment of the aquifer's hydrologic characteristics between the injection wells and the extraction well. Within a few days of test initiation, the bromide probe failed due to the arrival of sulfur-containing breakdown products from the CPS, as expected. At this point physical samples were collected daily or more frequently, and analyzed for bromide in a fixed laboratory. Sampling intervals and selected data from the slug tests and the tracer test are contained in Appendix A. Results of the tracer test using these data are discussed in Section 4.1.1.

3.3.2 Groundwater Chemistry

Groundwater from the extraction well was sampled before the test began and periodically as the test progressed. The extraction well and the injection wells were sampled after completion of the test. The sampling dates and analyses for each sample are presented in Table 3-4. Analyses were conducted at the Fluor Hanford Groundwater Remediation Project Field Laboratory in the 200 West Area, at the Waste Sampling and Characterization Facility in the 200 West Area, and at the Lionville Laboratory in Pennsylvania. The analytical constituents were determined as part of the data quality objective process (DOE/RL-2005-05), and consisted of the following:

- Field Laboratory: pH, ORP, dissolved oxygen, nitrate, nitrite, sulfate, and Cr^{6+}
- Waste Sampling and Characterization Facility: Cr^{6+} ; alkalinity; total organic carbon; chloride; nitrate; nitrite; sulfate; bromide; and the metals magnesium, manganese, potassium, sodium, calcium, total chromium, lead, and arsenic
- Lionville Laboratory: hardness and total inorganic carbon.

The interval at which samples were collected during the test was keyed to the amount of time anticipated for one pore volume to permeate the aquifer from the injection wells to the extraction well. This was modeled to be approximately 1 month, based on sparse aquifer data in the vicinity of the test. When breakthrough of the bromide tracer was detected after approximately 3 days, the sampling intervals were modified from weekly to two to three times per week.

Most of the samples were collected from the treatment tank feed line, through a valve installed just for this task. After the treatment system was winterized in September 2005, samples were obtained from the injection wells and extraction well with a bailer. Collection, bottling, labeling, and shipping were conducted as outlined in the sampling and analysis plan (DOE/RL-2005-05, Appendix A).

Complete analytical results are contained in Appendix B; quality assurance/quality control data are summarized in Section 4.2.

Table 3-4. Extraction Well Sampling Dates and the Laboratories.

Sampling Date	Field Laboratory	Waste Sampling and Characterization Facility	Lionville Laboratory
06/27/2005	X	X	X
06/30/2005	X	X	X
07/05/2005	X	X	X
07/06/2005	X		
07/08/2005	X		
07/12/2005	X	X	X
07/14/2005	X		
07/18/2005	X		
07/20/2005	X	X	X
07/22/2005	X		
07/25/2005	X		
07/27/2005	X		
07/28/2005	X	X	X
08/02/2005	X		
08/03/2005	X	X	X
08/05/2005	X		
08/08/2005	X		
08/09/2005	X		
08/10/2005	X	X	X
08/17/2005	X		
08/25/2005	X	X	
09/20/2005	X	X	
11/21/2005	X	X	
12/06/2005	X	X	

3.3.3 Process Data

Most of the process data collected during the treatability test were related to the volume of water and chemicals that went through the system. It was especially important to have accurate extraction and injection records to analyze and interpret the conservative tracer test and to characterize the hydrology. Measuring the flow and volume of chemicals also was important to ensure that the proper concentration of CPS was injected into the aquifer.

Manual readings from six different flowmeters were recorded during the test: one for the volume of water extracted from well 199-K-126, one to record the volume of CPS injected into the mixing tank, and one on each of the four injection well manifolds. A summary of these data is presented in Table 3-5; all of the process data collected are contained in Appendix C.

Table 3-5. Summary of Total Volume and Average Flow for Treatability Test.

Flowmeter	Total Volume (gal)	Average Flow (gal/min)
Extraction well	352,875	15.90*
Calcium polysulfide	25,028	0.97
Injection wells	353,572	12.60*
199-K-133	87,414	2.90
199-K-134	86,159	2.75
199-K-135	81,997	3.02
199-K-136	98,002	3.43

*Discrepancy of flow rate between injection wells and extraction well can be explained by (1) occasional inaccuracy in the injection well readings owing to clogging by organic additive, and (2) water was flowing into the injection wells for longer than the extraction pump was running.

3.4 DATA MANAGEMENT

The laboratory sampling data were managed and stored in the *Hanford Environmental Information System* database. All reports from fixed laboratories and supporting analytical data packages were subject to final technical review by qualified reviewers.

3.5 DEVIATIONS FROM THE WORK PLAN

The primary deviations from the work plan were as follows.

- The sampling interval was decreased, due to refinement of hydrologic conditions in the first few days of the test.
- Injection of the treated groundwater occasionally was unbalanced among the four wells because of mechanical problems with the injection pump, balancing valves in the injection wells, and the siphoning effect that made it hard to maintain balanced flow.
- Approximately 25 L (7 gal) of precipitate was captured during the process, less than the 70 L (18 gal) the laboratory scoping tests predicted. This did not negatively impact the test.
- Injection of the carbon source was suspended for days or sometimes weeks, due to clogging. This substance lost its emulsification as soon as it was injected into the 7 percent CPS solution, where it became separated into a liquid and a semi-solid.
- The extraction pump in well 199-K-126 clogged and flow degraded over 4 days during the last few weeks of the test. A white, chalky substance, later identified as elemental sulfur, collected on the pump screen and internal parts of the pump. This began occurring approximately 20 days after initiation of the test, when reaction products from the CPS migrated to the extraction well in sufficient concentration to cause the pump to plug.

- The system did not operate continuously until the treatment goals were met, partially because the extraction pump was clogging after only a few days of operation during the latter part of the test. The system typically was shut down over weekends.
- The bag filters that were placed downstream of the mixing tank (see Figure 3-5) plugged with precipitate during the initial mixing of the groundwater with CPS. The polyfiber filter bag hardened when it trapped the sulfur, after which the treated groundwater was rerouted to bypass the filters. New filter bags were installed and no additional precipitate was found in the filter bags until the test shut down and the mixing tank was cleaned.
- The test lasted for 45 days, instead of the anticipated 90 days, because the transmissivity of the aquifer was greater than that initially assumed.

4.0 RESULTS AND DISCUSSION

4.1 DATA ANALYSIS AND INTERPRETATION

Three different types of data were obtained during this test: hydrologic, hydrochemical, and process. Results are discussed separately below. The waste produced during operation of this technology also is presented and discussed.

4.1.1 Analysis of Slug and Tracer Test Data

Analysis of the pre-injection slug test results indicate relatively consistent estimates for hydraulic conductivity (i.e., 6.8 to 8.2 m/day [22 to 27 ft/day]) for the extraction well and three of the injection well sites. This suggests that hydrogeologic conditions were relatively uniform across the test area. It should be noted that the lower conductivity estimate for injection well 199-K-135 (i.e., 2.2 m/day [7.2 ft/day]) is considered to have a high level of uncertainty, due to the high dissipation of stress (i.e., greater than 90 percent) during slug testing.

Data from the post-injection slug test indicate that formation hydraulic conductivity increased slightly, ranging from 4.1 to 12.5 m/day (13.5 to 41 ft/day). This general increase in local formation hydraulic conductivity conditions may be attributable to mobilization and removal of fine-grained aquifer materials in the region immediately surrounding the wells, and/or minor dissolution of aquifer materials (e.g., calcium carbonate coatings on minerals) resulting from introducing CPS into the formation. These tests indicate a hydraulic conductivity of between 7 and 8 m/day (23 and 26 ft/day), which was relatively consistent among all five wells.

All 100-KR-4 OU injection wells exhibited high-conductivity ($\sim K \geq 40$ m/day [130 ft/day]) in the well screen and sandpack zone surrounding the well. The extraction well also showed a high-conductivity ($K = 18.1$ m/day [59.4 ft/day]) inner zone surrounding the well, but this zone also extends beyond the artificial sandpack; this is attributed to extended pumping/development during the time it was used as an extraction well.

Bromide tracer breakthrough levels at the extraction well peaked at a concentration level of 0.29 mg/L, 4.9 days after injection of the tracer pulse. Because the tracer containing groundwater was re-injected, the bromide tracer concentration at the extraction well did not decline to non-detection levels, but ranged between 0.15 and 0.25 mg/L over the 25-day period of tracer sample collection/observation.

Analysis of the tracer data was complicated by the fact that the wells used for the treatability test only penetrated the top 70 percent of the unconfined aquifer, and the injection wells and extraction well penetrate different aquifer depths. As a result, a unique analysis solution was not possible so ranges of hydrogeologic values were computed.

Based on numerical model analysis of the bromide tracer breakthrough pattern and sensitivity analysis runs, the following best-match estimate and parameter ranges are indicated for various hydraulic and transport parameters: effective porosity = 0.17, range = 0.10 to 0.25; vertical

anisotropy = 0.1, range 0.05 to 0.5; and longitudinal dispersivity = 45 m (148 ft), range = 15 to 45 m (49 to 148 ft). Because the tracer was re-injected at the test site along with the CPS reactant solution, tracer breakthrough (recovery limb) analysis is particularly insensitive to variations in dispersivity. A full presentation and discussion of these tests is contained in Appendix A.

4.1.2 Analysis of Treatability Test Chemical Data

Two important goals of this test that relate to the chemistry of the groundwater were to verify reduction in the groundwater and to evaluate the potential of any negative effects from this technology (e.g., significant mobilization of toxic metals). The data will be discussed in this section with those goals in mind. Groundwater chemistry data are presented in Appendix B.

Measurements of ORP and Cr^{6+} from the extraction well were the primary means used to evaluate the progress of the treatment test and monitor persistence of the treatment. As seen in Figure 4-1, ORP began dropping within 2 days after beginning the test, and had decreased to negative values after 7 days of treatment. Near the end of the test, approximately 40 days after the beginning of treatment, ORP was measured at -400 mV. Hexavalent chromium exhibited a similarly dramatic decline, dropping to less than detection (<1 $\mu\text{g/L}$) 20 days after starting the test (Figure 4-2). Nitrate was reduced to levels near zero during the test, but rose shortly after the test ended (Figure 4-3).

As discussed earlier, the treatment system was shut down over most weekends, allowing the aquifer to rebound. These rebound periods are marked in Figures 4-1 and 4-2, and yield a qualitative assessment of the completeness of aquifer reduction during the course of the test. Chromium levels in the extraction well increase after groundwater circulation has been shut off for several days, suggesting that the reduced groundwater is not communicating with all the aquifer materials. This indicates that the aquifer is hydrogeologically inhomogeneous, with the more transmissive layers being rapidly reduced when reductant is circulated. It takes longer for the reductant to infuse the lower transmissive layers, so when circulation is stopped chromium-containing groundwater "bleeds" from these (finer-grained) layers and is detected when pumping resumes.

Several constituents were monitored to determine if the treatment adversely influenced the aquifer. One of these constituents was sulfate, which can be a byproduct of CPS breakdown. Figure 4-4 shows the sulfate concentration increasing from a baseline value of 45 to 120 mg/L. This is below the secondary maximum contaminant level of 250 mg/L established by the U.S. Environmental Protection Agency, but the concentrations appear to be increasing and will continue to be monitored. To moderate sulfate increases in the aquifer, an organic substance was pumped into the injection wells to stimulate growth of SRB. Total organic carbon concentration was monitored to determine if the carbon source permeated the aquifer. None of the samples in the extraction well contained organic carbon above detection levels; at the end of the test the injection wells contained up to 39 mg/L organic carbon. It is not known how far into the aquifer the organic substance penetrated, but substantial amounts of semi-solid fat were found in the injection wells after completion of the treatability test.

Figure 4-1. Plot of Oxidation/Reduction Potential and Dissolved Oxygen of Samples Collected from Well 199-K-126.

Symbols with horizontal lines represent samples taken immediately after the system was shut down for at least 2 days.

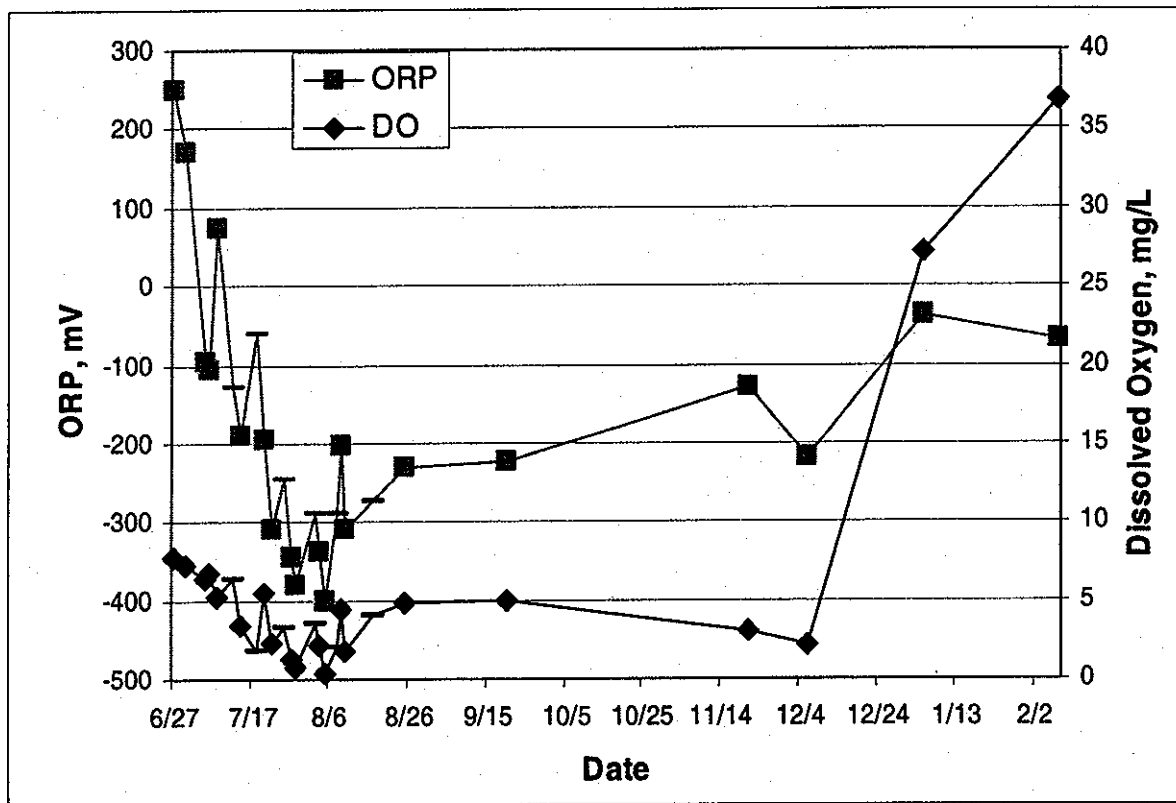

Figure 4-2. Plot of Hexavalent Chromium Versus Time for Samples Collected from Well 199-K-126.

Symbols with horizontal lines represent samples taken immediately after system was shut down for at least 2 days.

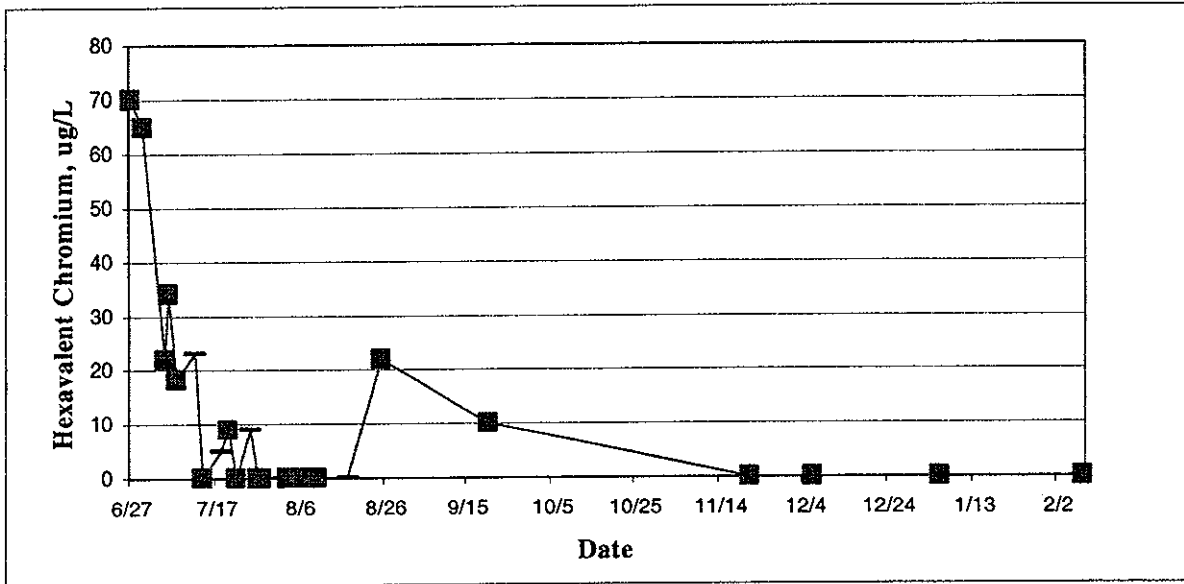

Figure 4-3. Nitrate and Nitrite Concentrations in Well 199-K-126.

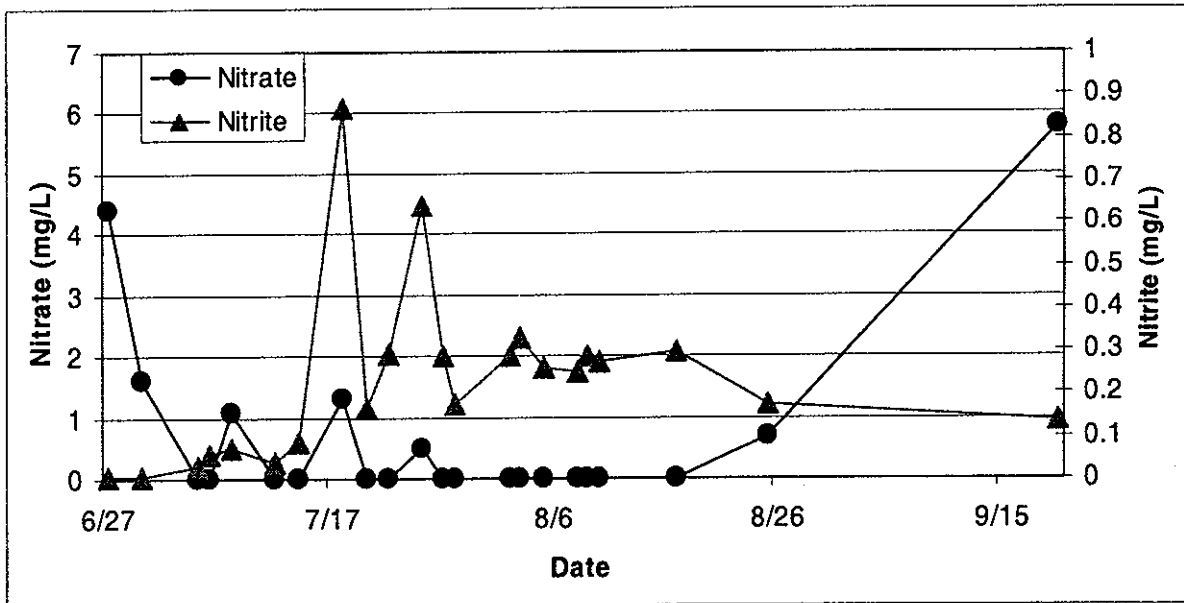
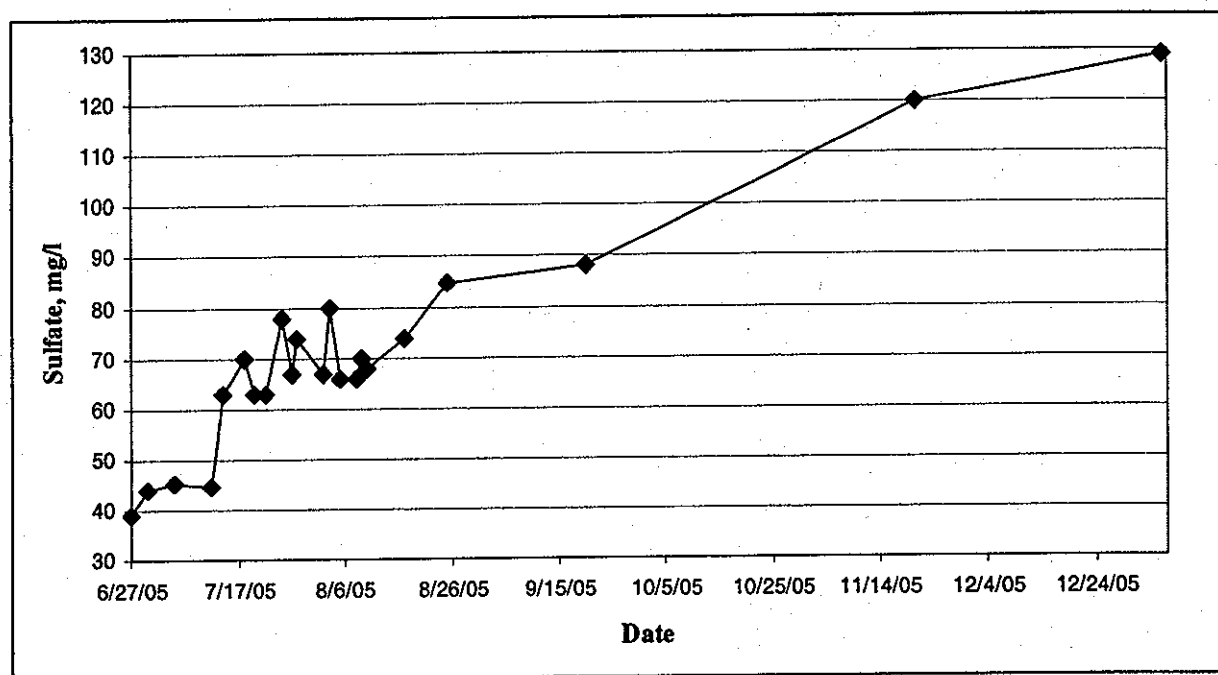

Figure 4-4. Sulfate Concentrations in Well 199-K-126.



Concentrations of certain metals were determined from samples collected from the injection wells and extraction well. As mentioned in Section 3.1, certain metals may be affected when the groundwater chemistry is perturbed from natural conditions. Some metals, such as chromium, become less mobile in a reduced environment and others, such as, arsenic, manganese, and iron, may become mobilized. The treatment also changed the pH and added calcium and sulfur, which could influence how constituents in the aquifer partition into groundwater.

Three elements that are particularly sensitive to redox conditions are arsenic, manganese, and iron. As seen in Figure 4-5, arsenic and manganese increase in concentration in the extraction well during the treatment test. Arsenic decreases soon after pumping ceases, and is below the initial concentration 3 months after the end of the test. Arsenic is rising in three of the four injection wells, but the highest value of 0.02 mg/L is almost 3 orders of magnitude below the drinking water standard (10 mg/L). Manganese concentrations continue to rise in the extraction well. Manganese has a secondary maximum contaminant level of 0.05 mg/L, owing to its ability to influence the smell and taste of water. Three of the four injection wells are below 0.05 mg/L.

Figure 4-5. Manganese and Arsenic Concentrations in Well 199-K-126.

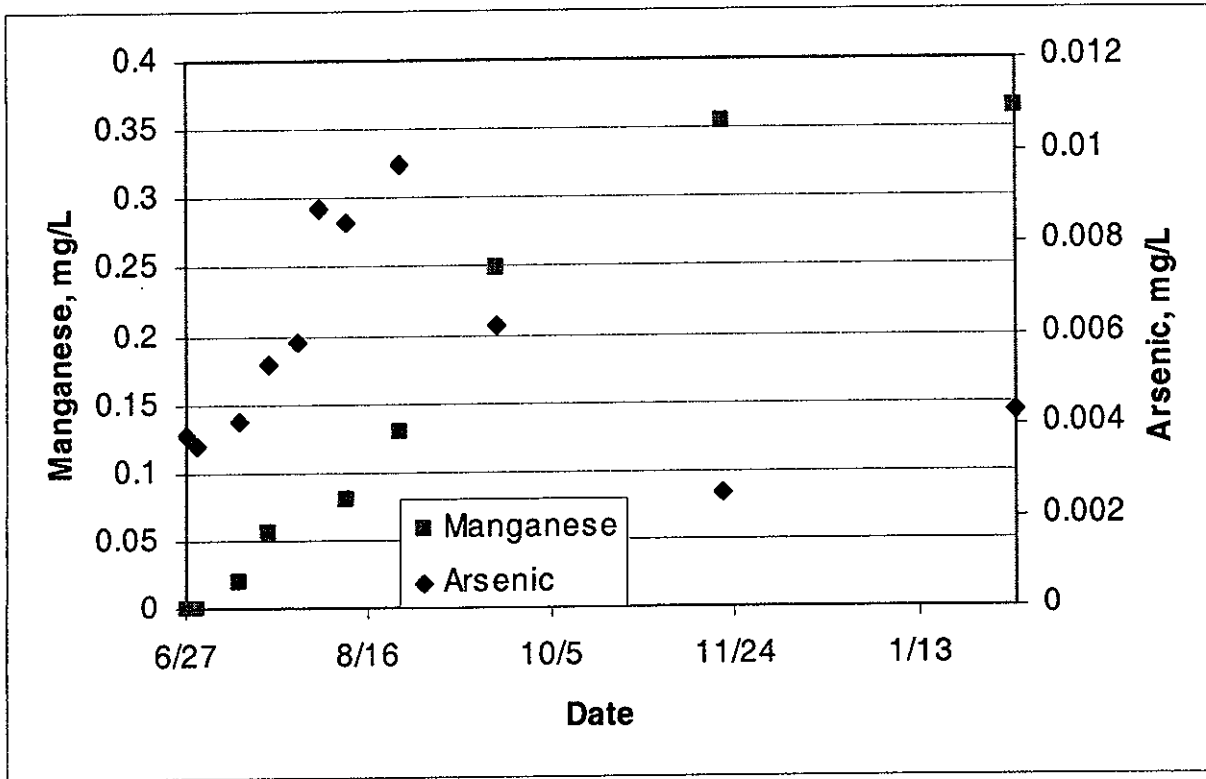

As discussed in Section 3.2.2.3, the extraction pump and other components periodically clogged during the last half of the treatability test. Samples collected from the extraction pump screen and injection pump impeller were analyzed by X-ray diffraction to determine their mineralogy. The “toothpaste-like” material that coated the extraction pump screen and internal parts was mostly elemental sulfur; it appeared that there was another component to this sample, but it was not identified. The hard, white coatings on the injection pump impeller were identified as calcium carbonate.

Iron remained at low levels in the extraction well throughout the test, but increased abruptly 2 to 3 months after ending the test, from generally less than detection limit (~ 0.03 mg/L) to 0.43 mg/L. The mobility of these metals should decrease to initial levels once they are carried out of the reduced zone by natural groundwater flow.

4.1.3 Analysis of Process Data

The flow data were used to interpret the tracer test (Appendix A) and to calculate the volume of aquifer reduced and the number of pore volumes of reactant that were circulated through the aquifer. Figure 4-6 depicts the extraction and injection volumes as a function of time, where periods of system shutdown are immediately obvious. A summary of the flow data collected is contained in Appendix C.

Figure 4-6. Plot of Cumulative Volume of Groundwater Extracted and Injected During the Treatability Test.

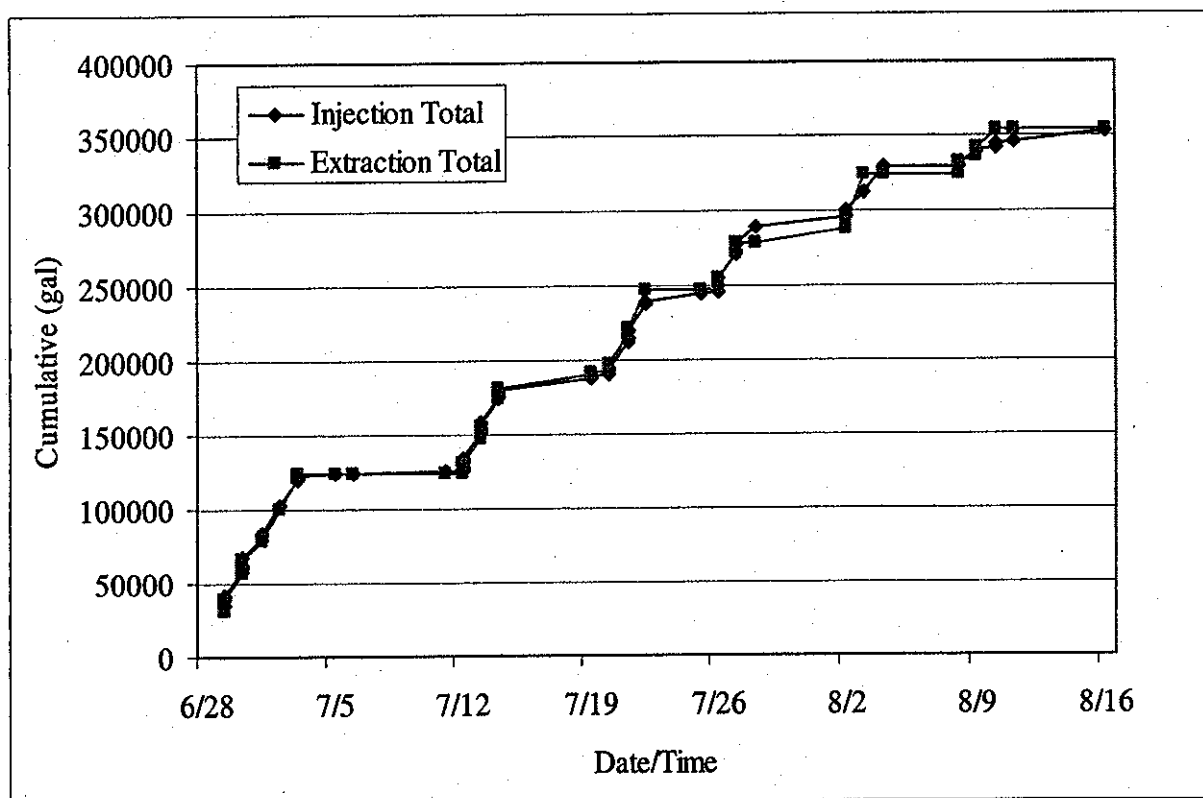

4.1.4 Analysis of Waste

The waste produced during the operation of this test includes miscellaneous solid waste (e.g., wipes) and precipitate produced during the reaction of CPS with groundwater. The latter consists mainly of calcium carbonate, sulfur, and chromium hydroxide (Equation 1). Approximately 25 L (7 gal) of precipitate was captured in the filters. A composite sample was collected from the four filter bags and analyzed by the Toxic Characteristics Leaching Procedure (SW-846, *Test Methods for Evaluating Solid Waste: Physical/Chemical Methods, Third Edition; Final Update III-A, Method 1311*). Results from this analysis are presented in Table 4-1, along with the regulatory limits for hazardous waste. Based on the results of this test, the waste would not be classified as hazardous. This waste was disposed of at the Hanford Site's Environmental Restoration Disposal Facility, in accordance with the 100-KR-4 OU waste management plan (DOE/RL-97-01).

Table 4-1. Analytical Results of Precipitate Produced from the Treatability Test.

Analyte	Result	Units	Land Disposal Limit
Arsenic	<0.01	mg/kg	5.0
Barium	0.0257	mg/kg	100
Cadmium	0.00573	mg/kg	1.0
Chromium	<0.007	mg/kg	5.0
Lead	0.00336	mg/kg	5.0
Mercury	0.00219	mg/kg	0.2
Selenium	0.0149	mg/kg	1.0
Silver	0.00438	mg/kg	5.0

4.1.5 Comparison to Test Objectives

The information provided earlier reveals that all of the test objectives were met. Chromium was reduced in the groundwater to less than detectable levels by application of CPS. Chemical analyses of the extracted groundwater were used to evaluate the influence of the treatment process on the mobility of aquifer constituents. Operational experience revealed several important "lessons learned" that will be incorporated if this technology is deployed on the Hanford Site.

4.2 QUALITY ASSURANCE/QUALITY CONTROL

Collection and analysis of operational and monitoring samples were carried out under the sampling and analysis plan for this test (DOE/RL-2005-05, Appendix A). The only deviation to this plan was the addition of manganese to the contaminants of interest.

A quality assurance project plan was included in the sampling and analysis plan (DOE/RL-2005-05, Appendix A) to meet the site-specific needs of the treatability test for sampling and analysis. The quality assurance project plan includes the following elements, which were developed during the data quality objectives process:

- Analytical performance: requirements for detection limits, precision, and accuracy
- Field quality control: frequency and type of quality control samples to be collected
- Quality objectives and criteria for measurement control
- Sample preservation, containers, and holding time
- Onsite measurements quality control
- Data management

- Data validation and usability: specific validation requirements, including the frequency and level of validation
- Technical specification: includes instrument calibration and frequency and inspection/acceptance requirements for supplies and consumables.

4.3 COSTS/SCHEDULE FOR PERFORMING THE TREATABILITY STUDY

Costs for this test are summarized in Table 4-2. The schedule is detailed in Figure 4-7.

Table 4-2. Actual Costs for the Treatability Test (in 1,000s).

Category	Planning	Design	Boreholes	Construction	Operation	Post-TTP	Subtotals
Labor	\$26.2	\$91.8	\$39.5	\$46.7	\$73.6	TBD	\$277.8
Materials	\$0.0	\$0.0	\$0.0	\$30.9	\$74.4	TBD	\$105.3
Subcontractors	\$19.8	\$0.0	\$180.8	\$161.9	\$81.9	TBD	\$444.4
Other costs	\$0.1	\$9.0	\$6.1	\$38.7	\$52.1	TBD	\$106.0
Subtotals	\$46.1	\$100.8	\$226.4	\$278.2	\$282	TBD	933.5
Grand total	\$933.4						

TBD = to be determined.

TTP = Treatability Test Plan.

Figure 4-7. Treatability Test Schedule.

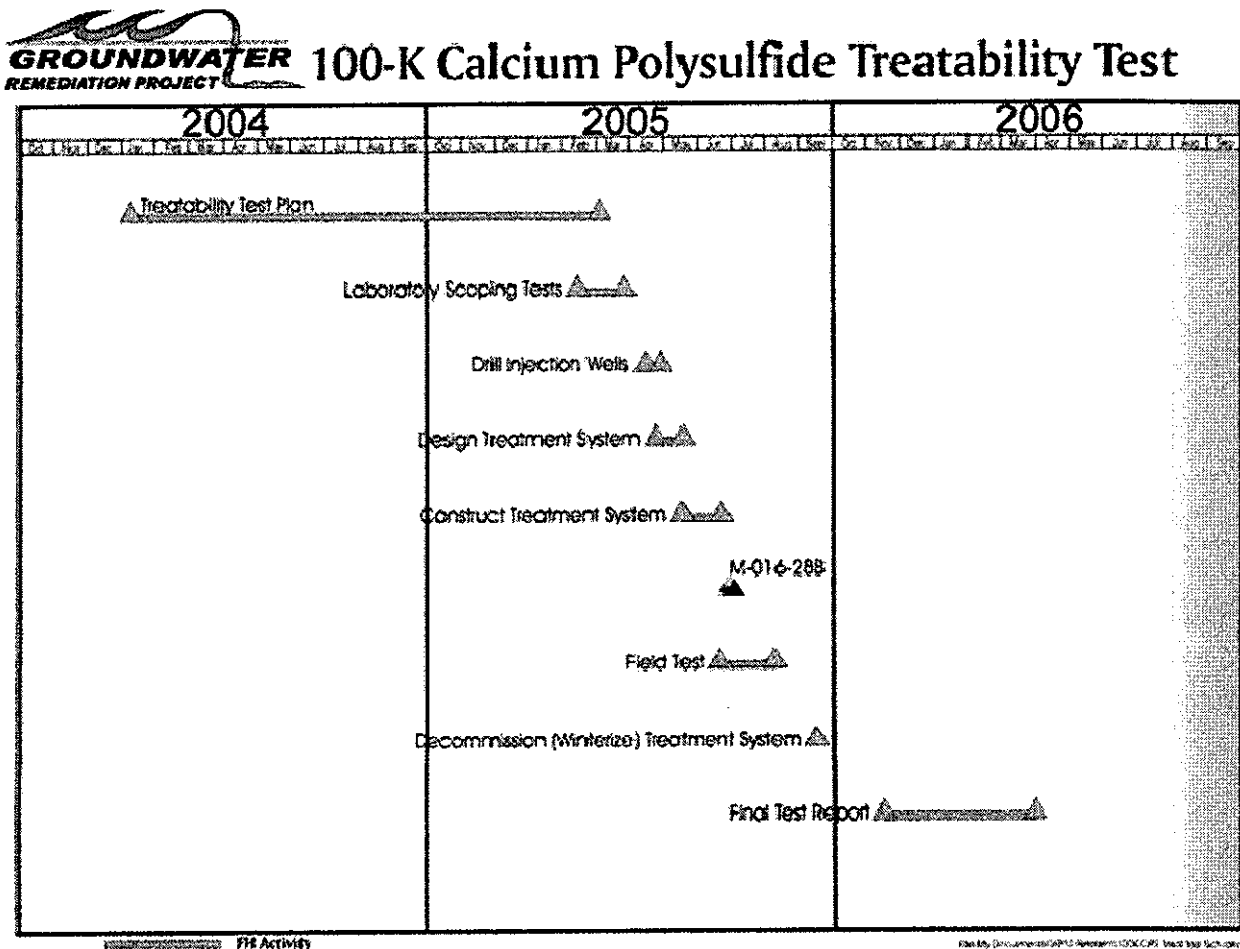

4.4 KEY CONTACTS

The following personnel should be contacted with questions/comments on this technology:

- Programmatic contact: K. M. Thompson, U.S. Department of Energy, Richland Operations Office
- Contractor contact: B. H. Ford/J. G. Riddelle, Fluor Hanford, Inc.

5.0 REFERENCES

- Blessing, T. C., and J. V. Rouse, 2002, "Keys to Successful In-Situ Remediation of Cr(VI) in Soil and Groundwater," *Proceedings of 97th Annual Meeting, American Wood Preserver's Association*, v-98, Minneapolis, Minnesota.
- Comprehensive Environmental Response, Compensation, and Liability Act of 1980*, 42 USC 9601, et seq.
- DOE/RL-97-01, 1997, *Interim Waste Management Plan for the 100-HR-3 and 100-KR-4 Operable Units*, Rev. 4, U.S. Department of Energy, Richland Operations Office, Richland, Washington.
- DOE/RL-2004-21, 2004, *Calendar Year 2003 Annual Summary Report for the 100-HR-3, 100-KR-4, and 100-NR-2 Operable Unit Pump-and-Treat Operations*, Rev. 0, U.S. Department of Energy, Richland Operations Office, Richland, Washington.
- DOE/RL-2005-05, 2005, *Treatability Test Plan for Fixation of Chromium in the Groundwater at 100-K*, Rev. 0, U.S. Department of Energy, Richland Operations Office, Richland, Washington.
- Ecology, EPA, and DOE, 1989, *Hanford Federal Facility Agreement and Consent Order*, 2 vols., Washington State Department of Ecology, U.S. Environmental Protection Agency, and U.S. Department of Energy, Olympia, Washington, as amended.
- Hanford Environmental Information System*, Hanford Site database.
- James, G., and R. Tibbals, 2004, "Two-Stage Biological Treatment of Acid Mine Drainage" (abstract), May, *Remediation of Chlorinated and Recalcitrant Compounds*, Monterey, California.
- Jenneman, G. E., and D. Gervertz, 1999, "Identification, Characterization, and Application of Sulfide-Oxidizing Bacteria in Oil Fields, Microbial Biosystems: New Frontiers," *8th International Symposium on Microbial Ecology*, Atlantic Canadian Society for Microbial Ecology, Halifax, Canada.
- NAVD88, 1988, *North American Vertical Datum of 1988*, National Geodetic Survey, Federal Geodetic Control Committee, Silver Spring, Maryland.
- Rouse, J. V., 2001, "In Situ Reduction and Geochemical Fixation of Chromium in Soils and Ground Water in Varied Geohydrological Regimes," July, *Journal of New England Water Environment Association*.
- Sheldon, J., and J. V. Rouse, 2000, *Sulfate Reduction Under Natural and Enhanced Conditions*, March, MWH for Valley Wood Preserving, submitted to U.S. Environmental Protection Agency, Region IX, San Francisco, California.

SW-846, 1999, *Test Methods for Evaluating Solid Waste: Physical/Chemical Methods, Third Edition; Final Update III-A*, Office of Solid Waste and Emergency Response, U.S. Environmental Protection Agency, Washington, D.C.

Van Hullebusch, E., M. Zandvoort, M. Vallerio, V. Astratinei, and P. Lens, 2004, "Examination of Chemical Speciation for Enhanced Metal Removal by Sulfate Reducing Bioreactors" (abstract), March, *14th Annual West Coast Conference on Soils, Sediments, and Water*, San Diego, California.

WAC 173-201A-240(3), "Toxic Substances," "Toxic Substances Criteria," *Washington Administrative Code*, as amended, Washington State Department of Ecology, Olympia, Washington.

WMP-27726, 2005, *Borehole Summary Report for Wells 199-K-133, 199-K-134, 199-K-135, and 199-K-136, FY 2005*, Rev. 0, Fluor Hanford, Inc., Richland, Washington.

WMP-28124, 2005, *Evaluation of Amendments for Mending the ISRM Barrier*, Fluor Hanford, Richland, Washington.

Zaluski, M., B. T. Park, and D. R. Bless, 2004, "Designing Sulfate-Reducing Bacteria Field-Reactors Using the BEST Model" (abstract), May, *Remediation of Chlorinated and Recalcitrant Compounds*, Monterey, California.

APPENDIX A

**HYDROLOGIC TEST CHARACTERIZATION RESULTS FOR THE 100-KR-4 ISRM
FIELD SITE DEMONSTRATION**

NOTE: This appendix contains *Hydrologic Test Characterization Results for the 100-KR-4 ISRM Field Site Demonstration*, as published in January 2006. The appendix contains the document in its entirety. Beginning with the cover page, pagination for this appendix will follow the pagination of *Hydrologic Test Characterization Results for the 100-KR-4 ISRM Field Site Demonstration*. Normal pagination will resume with the first page of Appendix B.

This page intentionally left blank.

S.W. Petersen
Page 1



Project No. 49454 (F76709)

Internal Distribution

Date
To S.W. Petersen
From F.A. Spane and D.R. Newcomer
Subject Hydrologic Test Characterization Results for the
100-KR-4 Calcium Polysulfide Field Site
Demonstration

K.J. Cantrell
J.S. Fruchter
T.J. Gilmore
K.A. Hedquist
R.L. Jackson
S.P. Luttrell
L.C. Swanson
V.R. Vermeul
File/LB

The following letter report presents the results of a series of hydrologic test characterizations that were conducted at the 100-KR-4 field demonstration site. The tests were designed to evaluate the hydrologic impact of calcium polysulfide treatment and its areal extent within the unconfined aquifer. The treatment zone was created by continuously withdrawing groundwater from a central extraction well (199-K-126), and injecting the chemically-treated, pumped groundwater at four, approximately equally-spaced injection wells (i.e., ~30 m). The effect of this treatment was to reduce hexavalent chromium in the groundwater to the less toxic and less mobile trivalent chromium, and to create a persistent reduced geochemical zone in the aquifer, which would continue to treat hexavalent chromium under natural groundwater-flow conditions.

Pre- and post-injection slug test characterizations were conducted at the KR-4 extraction and injection well sites for the purpose of assessing the local impact of calcium polysulfide treatment on existing in-situ aquifer hydraulic and storage characteristics. This is of importance, because significant decreases to the existing in-situ aquifer hydraulic properties can produce changes in the prevailing groundwater flow direction and limit the effectiveness of the created treatment zone for providing longer-term treatment of the contaminated groundwater plume. For assessing the hydrologic impact to aquifer hydraulic property conditions, pre- and post-injection hydraulic characterization tests were performed utilizing a series of multi-stress slug tests at the central extraction well and surrounding four injection well locations. Slug tests are significantly influenced by near well conditions; therefore, slight changes in hydraulic properties associated with the calcium polysulfide treatment are readily apparent by comparing and analyzing the pre- and post-injection slug test responses.

For assessing in-situ aquifer storage/porosity conditions prior to emplacement of the treatment zone, a forced-gradient, multi-well tracer test was conducted between the central extraction well (199-K-126) and one of the injection well locations (199-K-135). The test was conducted by injecting a "pulse" of conservative tracer (bromide) immediately prior to the start of continuously injecting calcium polysulfide solution at the four injection well centers. Analysis of the

conservative tracer breakthrough pattern provides pre-injection information concerning the effective porosity/storage characteristics over the inter-well region of the test site. Additionally, the tracer arrival and breakthrough pattern also provides information concerning the longitudinal dispersivity, which is an important parameter influencing the lateral extent of the treatment zone. Currently, no follow-on, post-injection tracer tests have been conducted that can be used for assessing any inter-well effective porosity/storage changes within the unconfined aquifer that can be attributed to the calcium polysulfide treatment.

Specifically, this letter report provides the analysis results of pre- and post-injection slug test characterizations and their comparison for individual KR-4 test well locations. A preliminary analysis of a conservative multi-well, forced-gradient, bromide tracer test is also provided using a homogeneous formation model approach. Additionally, based on characterization information provided by the pre- and post-injection slug tests and analysis of the bromide tracer test, computer simulations of area within the aquifer "contacted" by the circulated polysulfide reactant solution is provided. Based on the model predictions of the circulated reactant solution contact area (i.e., areal/vertical extent and concentration level) within the unconfined aquifer, inferences concerning the spatial distribution of treatment can be developed.

For ease in referencing results for the KR-4 field testing characterization program, the following letter report outline is provided:

Outline

1. Executive Summary
2. Introduction
 - 2.1 Site Description
 - 2.2 Well Construction
3. Slug Test Discussion
 - 3.1 Over-Damped Test Analysis Methods
 - 3.1.1 Bouwer and Rice Method
 - 3.1.2 Type-Curve Method
 - 3.2 Heterogeneous Formation Analysis
 - 3.3 Test Radius of Investigation
4. Pre-Injection Test Characterization
 - 4.1 KR-4 Injection Wells
 - 4.2 KR-4 Extraction Well
5. Injection Phase: Bromide Tracer Test and Calcium Polysulfide Injection
 - 5.1 Pre-Test Bromide Tracer Predictions
 - 5.2 Bromide Tracer Test: Observations/Analysis
 - 5.3 Calcium Polysulfide Injection Discussion

6. Post-Injection Test Characterization

6.1 KR-4 Injection Wells

6.2 KR-4 Extraction Well

7. Conclusions

8. References

Appendices

- A. Selected Pre-Injection Slug Test Analysis Plots
- B. Pre-Test Tracer Prediction Plots
- C. Miscellaneous Field Testing Pictures
- D. Selected Post-Injection Slug Test Analysis Plots

1. Executive Summary

A series of field test characterizations were conducted at the 100-KR-4 field demonstration site to assess the hydrologic impact of calcium polysulfide treatment on the unconfined aquifer and any associated implementability constraints for applying the technology. The treatment zone was emplaced by continuously withdrawing groundwater from a central extraction well (199-K-126), and re-injecting the filtered/treated pumped groundwater at four, approximately equally-spaced injection wells (i.e., ~30 m) surrounding the central extraction well location. The objective of this treatment was to reduce hexavalent chromium in the groundwater to the less toxic and less mobile trivalent chromium, and to create a persistent reduced zone in the aquifer which would continue to treat hexavalent chromium under natural groundwater flow conditions.

For the calcium polysulfide treated zone to provide effective, longer-term treatment of the contaminated groundwater plume, no significant changes in the aquifer hydraulic and storage characteristics, which may cause changes in the prevailing groundwater flow conditions, should be produced. To assess potential hydrologic impact on in-situ aquifer hydraulic property conditions, pre- and post-injection hydrologic test characterization was performed utilizing a series of multi-stress slug tests at the central extraction well and surrounding four injection well locations. Slug tests are significantly influenced by near well conditions; therefore, slight changes in near-well hydraulic properties associated with the calcium polyphosphate treatment are readily apparent by comparing and analyzing the pre- and post-injection slug test responses.

Pre-Injection Slug Test Characterization Results:

1. All KR-4 injection well sites exhibited a high-permeability ($\sim K \geq 40$ m/day) well-screen and sandpack zone surrounding the well-screen that "absorbs" ~80 to >90% of the imposed slug stress. The central extraction well (K-126) also exhibits a high-permeability ($K = 18.1$ m/day) surrounding, inner zone. This higher permeability zone extends beyond the emplaced artificial sandpack, and is attributed to extended pumping/development that may have occurred at this

site, since its completion as an extraction well for chromium contaminant plume management within the 100-KR4 Operable Unit.

2. Analysis of the pre-injection slug test results indicate relatively consistent estimates for hydraulic conductivity (i.e., 6.8 to 8.2 m/day) for the extraction well and three of the injection well sites. This suggests that hydrogeologic conditions were relatively uniform across the inter-well field test demonstration location prior to establishing the calcium polysulfide treatment zone. It should be noted that the lower permeability estimate for injection well 199-K-135 (i.e., 2.2 m/day) is considered to have a high-level of uncertainty, due to the high dissipation of stress (i.e., >90%) during slug testing.

Post-Injection Slug Test Characterization Results:

3. Comparison of pre- and post-injection slug test analysis results indicate that the calcium polyphosphate treatment produced no significant change in aquifer hydraulic properties within the immediate vicinity (i.e., within 2 to 3.5 m) of the KR-4 injection and extraction well locations. Specifically, two KR-4 test wells exhibited no change, while two wells displayed a slight increase and one well a decrease in aquifer hydraulic conductivity, based on a comparison of pre- vs. post-injection test type-curve analyses.
4. Higher projected test stress levels were consistently observed at all KR-4 injection well locations indicating that less of the applied stress was “*absorbed*” during the initial phases of the slug tests. These higher stress levels indicate a reduction of the porosity within the artificial, higher permeability inner/sandpack zone (i.e., from an assumed initial pre-injection porosity of 30%, to calculated post-injection sandpack porosity range of 6 to 13%.

Bromide Tracer Test Modeling Results

Tracer test characterization included two modeling elements: pre-injection test prediction and tracer test analysis.

5. The pre-injection slug test characterization results provided valuable input for designing and predicting tracer and reactant solution emplacement. Based on the results of the pre-injection modeling, the need for a ~50% higher bromide tracer pulse concentration was indicated to ensure detecting tracer breakthrough characteristics at the extraction well location. Based on these modeling predictions, a tracer designed solution (volume = 1,700 liters; concentration = 1,420 mg/L) was injected as a pulse (over ~55 minutes), a day before injection of the calcium polysulfide reactant solution.
6. Observed bromide tracer concentration levels at the extraction well peaked at a maximum concentration of 0.29 mg/L, 4.9 days following injection of the tracer pulse. Because the tracer containing groundwater was re-injected, the bromide

tracer concentration at the extraction well did not decline to non-detection levels, but ranged between 0.15 and 0.25 mg/L over the 25-day period of tracer sample collection/observation.

7. Mult-well, force-gradient tracer breakthrough patterns normally can be analyzed definitively to provide estimates for aquifer effective porosity and longitudinal dispersivity over the interwell distance. However, the fact that extraction well K-126 and the surrounding four injection wells do not fully penetrate the unconfined aquifer and penetrate different aquifer depths greatly increases the influence of aquifer vertical anisotropy ratio ($K_D = K_v/K_h$) on tracer breakthrough characteristics and greatly increases the uncertainty and complexity of the tracer analysis. As a result, a "unique" analysis solution is not possible based on these three tracer-influencing aquifer parameters (i.e., n_e , D_l , K_D).
8. Based on numerical model analysis of the bromide tracer breakthrough pattern and sensitivity analysis runs, the following best-match estimate and parameter ranges are indicated for various hydraulic and transport parameters: effective porosity = 0.17, range = 0.10 to 0.25; vertical anisotropy = 0.1, range 0.05 to 0.5; and longitudinal dispersivity = 45 meters, range = 15 to 45 meters. Because the tracer was re-injected at the test site along with the calcium polysulfide reactant solution, tracer breakthrough (recovery limb) analysis is particularly insensitive to variations in dispersivity.

Polysulfide Reactant Solution Modeling Results

9. Computer model simulations utilizing characterization information provided by pre- and post-injection slug tests and analysis of the multi-well, forced-gradient bromide tracer test were conducted to estimate the areal and vertical extent of the circulated polysulfide reactant solution within the KR-4 field demonstration location. These computer simulations did not take into account geochemical reactions, chemical diffusion or reactant density effects. Based on the model predictions of the circulated reactant solution contact area (i.e., areal/vertical extent and concentration level) within the unconfined aquifer, inferences concerning the spatial distribution of treatment can be developed.
10. Computer model simulations produce a characteristic "clover-leaf" contour pattern that is developed within the aquifer over the inter-well extraction and injection well region. The areal extent is less extensive within the lower-section of the unconfined aquifer. This is attributed to the existing partially penetrating well/aquifer relationships and the aquifer vertical anisotropy.
11. As expected, higher percentages of the reactant solution are located near injection well locations, while conversely lower reactant percentages occur at the central extraction well location. The lower reactant concentration in the vicinity of the extraction well is, in part, attributed to the wells' partial penetration to aquifer thickness aspect ratio, which causes significant vertical gradients immediately around the extraction well location. The presence of vertical

gradients causes the extraction well to derive a significant percentage of pumped water from deeper, "untreated" sections of the unconfined aquifer.

2. Introduction

The 100-KR-4 field demonstration was designed to evaluate the performance of calcium polysulfide as a remedial alternative for chromate-contaminated groundwater within the area. The treatment zone was created by continuously withdrawing groundwater from a central extraction well (199-K-126), and re-injecting the filtered/treated groundwater at four, approximately equally-spaced injection wells (i.e., ~30 m from K-126) that surround the central extraction well location (see well location Figures 2.1 and 2.2). The pumped groundwater from the extraction well was discharged to a 5,500 gallon capacity surface mixing tank and was treated with a concentrated calcium polysulfide solution (29 percent solution) creating a designed 7 percent solution (i.e., of calcium polysulfide) for re-injection at the four injection well sites. The re-injected fluid provides direct reductive treatment of hexavalent chromium in groundwater and geochemically reacts with the aquifer matrix to produce a redox-altered zone within the unconfined aquifer, providing additional longer-term treatment capacity for groundwater migrating through the treatment zone. The use of calcium polysulfide has been shown at several non-Hanford remediation sites to be successful in precipitating highly soluble toxic metals within contaminated aquifers, into less soluble and nontoxic metal sulfides (e.g., Jacobs et al., 2001, Messer et al., 2003).

As part of the field demonstration investigation, hydrologic characterization tests were conducted for the purpose of assessing the impact of the calcium polysulfide treatment on existing in-situ aquifer hydraulic and storage characteristics. Significant decreases to the existing in-situ aquifer hydraulic properties could produce changes in the prevailing groundwater flow direction and limit the effectiveness of the treatment zone for providing longer-term treatment of contaminated groundwater. For assessing the hydrologic impact to aquifer hydraulic property conditions, baseline hydraulic properties in the immediate vicinity of the extraction-injection well systems were characterized prior to and immediately following the calcium polysulfide injection. The pre- and post-injection hydraulic property characterization was performed utilizing a series of multi-stress slug tests at the central extraction well (199-K-126) and four surrounding injection well locations (199-K-133, -K-134, -K-135, and -K-136). Slug tests are significantly influenced by near well conditions; therefore, slight changes in near-well hydraulic properties associated with creating the treatment zone should be readily apparent by comparing and analyzing the pre- and post-injection slug test responses.

For assessing possible changes to aquifer storage/porosity conditions, a forced-gradient, multi-well tracer test was conducted between extraction well 199-K-126 and injection well 199-K-135. The test was conducted by injecting a "pulse" of conservative tracer (bromide) immediately prior to the start of continuously injecting calcium polysulfide solution at the four injection well centers. The analysis of the conservative tracer breakthrough pattern provides pre-injection information concerning the effective porosity /storage characteristics over the inter-well region of the test site. Additionally, the tracer arrival and breakthrough pattern also provides information concerning the longitudinal dispersivity, which is an important parameter influencing the lateral extent of the

created redox-reactive zone. Currently, no follow-on, post-injection tracer tests have been conducted that can be used for assessing any inter-well effective porosity/storage changes within the unconfined aquifer that can be attributed to the calcium polysulfide treatment. This letter report provides an analysis of the hydrologic impact of creating a reactive treatment zone at the KR-4 field test site, based on pre- and post-injection slug test analysis/comparisons for the individual KR-4 test well locations. Additionally, a preliminary analysis of the conservative multi-well tracer test is provided, which can be used to assess pre-injection storage/effective porosity conditions of the unconfined aquifer prior to creating the redox-reactive zone. These pre-injection storage/effective porosity estimates are useful for estimating the spatial distribution of treatment that would be realized by injecting the calcium polysulfide reactant solution.

2.1 Site Description

As noted in Peterson et al. (2002), the uppermost hydrologic unit beneath the 100-K Area is the Ringold Formation Unit E, which consists of heterogeneous sandy gravel deposits of low-to-moderate transmissivity. The contact with the overlying, more transmissive Hanford formation (informal stratigraphic designation), lies above the prevailing water table, which at the KR-4 field test site is ~20 m below land surface. The unconfined aquifer thickness at the field test locality is ~13.7 m, with its lower boundary contact occurring at the top of the Lower Mud unit of the Ringold Formation. Comprehensive descriptions of the groundwater conditions within the general 100-K Area are contained in a variety of technical reports issued by the Hanford Groundwater Monitoring Project. The most recent update of the 100-K Area conceptual hydrogeologic model and current groundwater contamination conditions is provided in Hartman et al., (2004 ; Peterson and Swanson, Chapter 2.3). As noted in Peterson et al. (2002), only limited hydrologic property information is available for this Hanford Site region. Based on these available single-well hydrologic test results, hydraulic conductivity for the unconfined aquifer in this region ranges between approximately 2 to 30 m/day.

2.2 Well Description

The 100-KR-4 test well facilities were constructed for performing the calcium polysulfide injection test within the unconfined aquifer for the treatment of chromate-contaminated groundwater. As noted previously, the treatment zone was created by continuously withdrawing groundwater from a central extraction well (199-K-126), and re-injecting the filtered/treated pumped groundwater at four, approximately equally-spaced injection wells (i.e., ~30 m from K-126) that surround the central extraction well location (see Figure 2.2).

Central well K-126 was air-rotary drilled during CY-1999 with a borehole diameter of 0.2540 m, and completed with a 0.1524 m I.D. diameter, stainless steel 0.020-slot wire-wrapped well screen. The extraction well has a blank 0.927 m casing section below the well-screen to act a sump for collecting infill debris. A 10-20 mesh, Colorado silica sand sandpack was emplaced within the annular area between the well screen and borehole wall. Well K-126 has been used since its completion as an extraction well for chromium contaminant plume management within the 100-KR4 Operable Unit region. Its location and relationship with other surround 100-K Area wells and facilities is shown in Figure 2.1.

All four surrounding KR-4 injection wells were air-hammer drilled during FY-2005 with a borehole diameter of 0.2286 m, and completed with a 0.1016 m I.D. diameter, stainless steel 0.090-slot wire-wrapped well screen. Each injection well has a blank 0.914 m casing section below the well-screen to act a sump for collecting infill debris. A 4-8 mesh, Colorado silica sand sandpack was emplaced within the annular area between the well screen and borehole wall. The larger well-screen slot size and larger mesh sandpack were designed to provide maximum hydraulic communication (i.e., minimize well plugging) with the surrounding unconfined aquifer for accommodating the calcium polysulfide reactant solution injection. Table 2.1 provides pertinent well completion depth/elevation information for each of the KR-4 test wells immediately prior to pre-injection activities.

3. Slug Test Discussion

Because of their sensitivity to changes in near-well hydraulic/storage property conditions, a comparison of pre- and post-injection slug test characterization results were implemented for assessing the hydrologic impact of the calcium polysulfide treatment. For assessing the hydrologic impact to aquifer hydraulic property conditions, baseline hydraulic properties in the immediate vicinity of the extraction-injection well systems were characterized prior to and immediately following treatment with the polysulfide reagent solution. The pre- and post-injection hydraulic property characterization was performed utilizing a series of multi-stress slug tests at the central extraction well (199-K-126) and four surrounding injection well locations (199-K-133, -K-134, -K-135, and -K-136). As noted previously, slug tests are significantly influenced by near well conditions; therefore, slight changes in hydraulic properties associated with creating the reactive zone should be readily apparent by comparing and analyzing the pre- and post-injection slug test responses.

(Note: The following discussion pertaining to general slug test response and analysis is taken largely from Spane and Newcomer (2004). The reader is directed to this reference for a more detailed discussion on slug test characterization) Slug test stresses imposed during pre- and post-injection characterization testing were produced by *rapidly* submerging (slug injection) or withdrawing (slug withdrawal) various-sized slugging rods of known volumetric displacement. At all test sites, two different size slugging rods were used to impart varying stress levels for individual slug tests. The slug tests were repeated at each stress level to assess reproducibility of the test results. Comparison of the normalized slug-test responses is also useful to evaluate stress-dependent, non-linear test well conditions. Evidence of stress dependence for tests within low to intermediate permeability formations, may indicate the effectiveness of well development, and the presence of near-well heterogeneities and dynamic skin conditions, as noted in Butler et al. (1996). Dynamic skin conditions refer to the non-repeatability of test responses conducted at a particular stress level. This non-repeatability of test response is commonly associated with changing formational conditions near the well caused by incomplete well development. As described in Butler (1997), hydraulic property characterization results obtained from wells exhibiting stress dependence should be viewed with caution; with more credence given to test responses exhibiting less lagged response characteristics (e.g., tests conducted at lower stress levels). Conversely, wells exhibiting

repeatable slug test response at different stress levels indicate a stable or static formation condition surrounding the well, and suggest that well has been effectively developed. Because of potential infilling of the well screen with sandpack materials due to the well construction design utilized at the four surrounding injection wells, only slug injection tests were conducted at these well site locations. Both slug injection and withdrawal tests were conducted at the central extraction well 199-K-126.

Normally, for unconfined aquifer wells with the water-table boundary located within the well-screen section, slug withdrawal tests are preferred over slug injection tests. This is due to the uncertainty of the contribution of the overlying vadose zone to the overall test response during slug injection tests (i.e., some of the imposed elevated well water column flows through the well screen into the overlying unsaturated zone above the water table). Bouwer (1989) indicates that for these test conditions, over-estimation of aquifer hydraulic properties can occur as the ratio of the applied stress, H_0 , to saturated well-screen length, L , increases. For slug injection tests conducted at the KR-4 injection well sites, the theoretically applied H_0 stress values ranged between 0.44 to 1.14 m within saturated well-screen lengths (L) that ranged between 7.2 and 7.9 m. The H_0/L ratios utilized for these tests are well within the 25% stress-ratio criteria recommended by Butler (1997) for these test conditions; therefore, no significant bias in slug injection test analysis results would be expected. To examine this more quantitatively, slug injection and slug withdrawal test results were conducted and compared for the central extraction well location (199-K-126), which did not have the same well-screen/sandpack stability concerns (i.e., smaller well-screen slot-opening size). Slug injection and withdrawal tests performed at the extraction well site produced nearly identical test responses and analysis results. This suggests that slug injection tests conducted at the four KR-4 injection well sites should provide reliable test analysis results for these locations.

As discussed in Butler (1997), water levels within a well can respond in one of three ways to the instantaneously applied stress of a slug test. As shown in Figure 3.1, these response model patterns are: 1) an over-damped response, where the water levels recover in an exponentially decreasing recovery pattern; 2) an underdamped response, where the slug test response oscillates above and below the initial static, with decreasing peak amplitudes with time; and 3) critically damped, where the slug test behavior exhibits characteristics that are transitional to the over- and under-damped response patterns. Factors that control the type of slug test response model exhibited within a well include a number of aquifer properties (hydraulic conductivity) and well dimension characteristics (well-screen length, well-casing radius, well-radius, fluid-column length) and can be expressed by the response damping parameter, C_D , which Butler (1997) reports for unconfined aquifer tests as:

$$C_D = (g/L_c)^{1/2} r_c^2 \ln(R_c/r_w) / (2KL) \quad (3.1)$$

Where

g	=	acceleration due to gravity
L_c	=	effective well water-column length
r_c	=	well casing radius; i.e., radius of well water-column that is active during testing

R_c	=	effective test radius parameter; as defined by Bouwer and Rice (1976)
r_w	=	well radius
K	=	hydraulic conductivity of test interval
L	=	well-screen length.

Given the multitude of possible combinations of aquifer properties, well casing dimensions, and test interval lengths, no universal C_D value ranges can be provided that describe slug test response conditions. However, in considering various test site conditions that are encountered at the KR-4 injection well sites (i.e., with a saturated well-screen length, $L = 7.2$ to 7.9 m, and well casing radius, $r_c = 0.051$ m), the following *general* guidelines on KR-4 slug test response prediction are provided, which are based on test simulations using the computer program presented in Butler et al. (2003):

$C_D > 3$	=	over-damped response
$C_D 1 - 3$	=	critically-damped response
$C_D < 1$	=	under-damped response

As noted in Spane and Newcomer (2004), over-damped test response generally occurs within test wells monitoring low to moderately high permeability formations on the Hanford Site (e.g., Ringold Formation), and are indicative of test conditions where frictional forces (i.e., resistance of groundwater flow from the test interval to the well) are predominant over test system inertial forces. In contrast, tests exhibiting critically-damped or under-damped response behavior are indicative of test conditions when inertial forces are significant or predominant, respectively. As will be discussed, all KR-4 test wells exhibited only over-damped slug test responses; both during pre- and post-injection test characterization. For this reason, the following discussion will only pertain to over-damped slug tests. As noted previously, a more comprehensive discussion that includes critically-damped and under-damped test conditions is presented in Spane and Newcomer (2004).

For over-damped slug tests, two different methods were used for the KR-4 slug-test analysis: the semiempirical, straight-line analysis method described in Bouwer and Rice (1976) and Bouwer (1989) and the type-curve-matching method for unconfined aquifers presented in Butler (1997).

3.1 Over-Damped Test Analysis Methods

The following sections provide a brief discussion of analytical methods and considerations for slug tests exhibiting over-damped responses.

3.1.1 Bouwer and Rice Method

The Bouwer and Rice method is a well-known technique and is widely applied in the analysis of slug tests. A number of analytical weaknesses, however, limit the successful application of the Bouwer and Rice method for analyzing slug-test response. These weaknesses constrain its

application to slug-test responses that exhibit steady-state flow, isotropic conditions, no well-skin effects, and no elastic (storage) formation response. Unfortunately, these limitations are commonly ignored, and the Bouwer and Rice method is applied to slug-test responses that do not meet the test analysis criteria. A more detailed discussion on the analytical limitations of the Bouwer and Rice method is provided in Spane and Newcomer (2004).

Because of its semi-empirical nature, analytical results obtained using the Bouwer and Rice method (i.e., in contrast to results obtained using the type-curve-matching method) may be subject to error. Bouwer and Rice (1976) indicated that the K estimate, using their analysis method, should be accurate to within 10% to 25%. Hyder and Butler (1995) state an accuracy level for the Bouwer and Rice method within 30% of actual for homogeneous, isotropic formations, with decreasing levels of accuracy for more complex well/aquifer conditions (e.g., well-skin effects). For these reasons, greater credence is generally afforded the analytical results obtained using the type-curve-matching approach, which has a more rigorous analytical basis. The results obtained from the Bouwer and Rice method, however, are included in this study simply for comparison purposes with those obtained using the more rigorous type-curve analysis procedure.

3.1.2 Type-Curve Method

Because the type-curve method can use all or any part of the slug-test response in the analysis procedure, it is particularly useful for analyzing unconfined aquifer tests; both diagnostically and for analytical property characterization. The method also does not have any of the aforementioned analytical weaknesses of the Bouwer and Rice method. To facilitate the standardization of the KR-4 slug-test type-curve analyses, a set of initial analysis parameters was assumed:

- a vertical anisotropy, K_D , value of 1
- a specific storage, S_s , value of 0.00001 m^{-1}
- a well-screen interval below the water table equivalent to the test-interval section.

To standardize the slug-test type-curve-matching analysis for all slug-test responses, a K_D value equal to 1 was assumed. As noted in Butler (1997), this is the recommended value to use for slug-test analysis when setting the aquifer thickness to the well-screen length. Previous investigations by F. A. Spane (author) have indicated that single-well slug-test responses are relatively insensitive to K_D ; therefore, the use of an assumed (constant) value of 1 over a small well-screen section (i.e., ≤ 10 meters long) is not expected to have a significant impact on the determination of hydraulic conductivity, K_h , from the type-curve-matching analysis.

To facilitate the unconfined aquifer slug-test type-curve analysis, an S_s value of 0.00001 m^{-1} was used for all initial analysis runs. After initial matches were made through adjustments of transmissivity, T , additional adjustments of S_s were then attempted to improve the overall match of the test-response pattern. In most test cases, slight modifications were made to the input S_s values to improve the final analysis type-curve matches. However, other factors influence the shape of the slug-test curve (e.g., skin effects, K_D). For this reason, the S_s estimate obtained from the final slug-test analyses is considered to be of only qualitative value and should not be used (as

in the case for K_h) for quantitative applications.

The type-curves analyses presented in this letter report were generated using the KGS program described in Liu and Butler (1995). The KGS program is not strictly valid for the boundary condition, where the water table occurs within the well screen. However, a comparison of slug-test type curves generated from converted pumping test type curves (as described in Spane 1996), which accounts for this boundary effect, indicates very little difference in predicted responses when compared to the KGS model results. Because of this close comparison and the fact that the KGS program calculates slug-test responses directly and can be applied more readily for analysis of the slug-test results, it was used as the primary type-curve-analysis method in this report.

3.2 Heterogeneous Formation Analysis

Inherent in the analytical methods discussed above is the assumption that the test interval is homogeneous. A number of formation heterogeneities, however, can exert significant influence on slug-test response. Recognized heterogeneous formation conditions affecting slug-test response include multi-layers of varying hydraulic properties within the well-screen section, presence of linear boundaries, and radial variation of hydraulic properties with distance from the well (i.e., radial boundaries). The impact of these heterogeneous formation conditions on slug test response is discussed in Spane and Newcomer (2004). Of particular relevance to the KR-4 slug test characterization, is the impact of the radial variation of hydraulic properties from the well (i.e., abrupt radial permeability boundaries) imposed either artificially by well construction conditions (e.g., sandpack installations at the KR-4 injection well sites) and/or by prolonged pumping development (e.g., extraction well K-126). In either case, an extremely high permeability zone is created immediately outside the KR-4 test wells, which is not reflective of in-situ formation conditions.

The effects of radial variations of hydraulic properties surrounding test wells have been investigated previously in studies examining slug tests in the presence of finite-thickness skin (e.g., Moench and Hsieh 1985). A finite-thickness skin is essentially a radial boundary condition surrounding a fully-penetrating well, where the inner zone has significantly different hydraulic properties than the outside zone. A *negative skin* refers to the case where K_h of the inner zone is much greater than that of the outer zone (i.e., $K_1 \gg K_2$); while a *positive skin* denotes the opposite condition (i.e., $K_1 \ll K_2$). The effects of a radial boundary on slug-test response are largely a function of the contrast in K_h for the inner and outer zone, the storage characteristics, and radial distance from the well to the permeability boundary. Given the well construction characteristics of the KR-4 injection wells and the extended pumping/development that have occurred at the K-126 extraction well, higher permeability conditions (i.e., negative skin) are expected for pre-injection slug test characterizations.

Spane and Newcomer (2004) show the predicted slug-test responses for a negative (high permeability) finite-thickness skin condition, where the inner zone has a K_h 100 times greater than the outer zone, for various selected radial boundary distances (0.5, 1, 2 meters). The test responses were generated using the KGS program referenced in Section 3.1.2, which can account for finite-thickness well-skin conditions. For comparison purposes, homogeneous slug-test responses (i.e., no radial boundary) for the K_h representative solely of the inner and outer zones

also are provided. For this example, the storativities, S , for both zones are set equal and representative of elastic formation conditions ($S_1 = S_2 = 0.001$). An examination of Figure 3.2 indicates several important features. During early-test times, all the radial boundary examples follow the higher-permeability inner zone response (i.e., homogeneous formation response), with the duration of coincidence being directly associated with distance to the radial boundary. The presence of the radial boundary is exhibited by the departure from higher-permeability inner-zone response, where the test response becomes flatter (recovery rate decreases) and transitions to a combined composite test response, reflective of the hydraulic properties inside and outside the radial boundary. Recognizing whether radial flow boundaries are present within the slug-test response may be difficult unless the transition period segments of the test are distinct. Recognizing the presence of radial boundaries, however, is more apparent when slug test derivative plots are employed. Figure 3.3 shows the predicted slug-test derivative responses for the same test conditions presented in Figure 3.2. As shown, radial boundaries for the distances greater than 0.5 meter are denoted by a derivative pattern exhibiting multiple peaks or a stair-step pattern, which is in contrast to the smooth, single peak derivative pattern exhibited by homogeneous formations. For radial distances extremely close (e.g., <0.5 meter) or far (e.g., >5 meters) from the test well, the presence of boundaries may not be detected within the test response.

Figure 3.4 shows the predicted slug-test responses for a positive finite-thickness skin condition, where the inner zone has a K_h 0.01 times that of the outer zone, for the same selected radial boundary distances (0.5, 1, 2 meters) and test conditions examined for the negative skin case (only the K_h values for the inner and outer zones are reversed). (Note: this test case example is analogous to the presence or creation of a lower permeability zone immediately around the well, as could occur at the KR-4 test wells due to injection of the reactant solution into the surrounding aquifer). As for the previous negative-skin example, during early-test times, the various heterogeneous responses follow the inner zone response (i.e., homogeneous formation response), with the duration of coincidence being directly associated with distance to the radial boundary. The presence of the radial boundary is exhibited by the departure from the lower-permeability, inner zone response, where the test response becomes steeper (recovery rate increases), with test recovery becoming reflective of a combined composite test response reflective of the hydraulic properties inside and outside the radial boundary. The increased steepness in test response due to the presence of a radial boundary between lower and higher permeability zones (i.e., finite-thickness, positive-skin), becomes more apparent when type-curve analysis methods are used (i.e., in comparison to the Bouwer and Rice method). As discussed in Butler (1997), the analysis of slug tests affected by positive-skin conditions often requires use of homogeneous formation type curves with unrealistically low storativity values (i.e., to match the entire test response). For this reason, Butler (1997) recommends the use of type-curve analysis for slug tests to detect whether positive skin-radial boundaries are present within the test response.

All KR-4 wells exhibit effects of heterogeneous formation-radial boundary conditions for the two test characterization phases, with very high permeability ($K > 40$ m/day) inner zone conditions (negative skin). As discussed in Section 2.2, the presence of the high-permeability inner zone around the KR-4 injection wells is attributed to the well completion design (well screen/sandpack mesh size), while the high permeability condition at the KR-4 extraction site is attributed to a combination of well completion design and induced development from extended pumping at this site. The effect of the pumping development causes an extension of the higher-permeability boundary zone away from the extraction well location (i.e., beyond the physical, artificial boundary

imposed by the well completion).

No complete slug-test response analyses (i.e., using K_h values for the inner and outer zones) were attempted, however, using the finite-thickness, skin solution available within the KGS program (as shown in Figures 3.2, 3.3, and 3.4). This is due to the non-uniqueness of the analytical solution (i.e., similar test responses can be derived using different combinations of K , S and skin/inner zone thickness). For tests exhibiting heterogeneous formation behavior, the inner and outer zone test responses were analyzed independently using the homogeneous formation analysis approach. (Note: because of the rapid recovery during the initial test response phase, inner-zone characterization was limited to only a few of the tests that had sufficient data for analysis). For the outer zone test characterization, which is more representative of actual formation/aquifer conditions, the homogeneous formation analysis procedure outline in Butler (1997) and described in Spane and Newcomer (2004) was used. This homogeneous formation analysis approach ignores the early-time test data reflecting the higher permeability inner zone and the outer zone test stress level (H_{p-out}) is calculated by projecting the observed, outer zone test data back to the time of test initiation, H_p . For analysis of the outer zone response, an equivalent well radius, r_{eq} must be used instead of the actual well-casing radius, r_c , in the various analytical methods. The r_{eq} is calculated by using the following relationship presented in Butler (1977):

$$r_{eq} = r_c (H_o / H_p)^{1/2} \quad (3.2)$$

where, H_o is the theoretical stress applied within the well casing, r_c . This approach was utilized for the analysis of extraction well K-126, which has a developed higher permeability inner zone, extending into the surrounding formation outside the emplaced sandpack.

It should be noted that r_c term used in slug test analysis and in Equation 3.1 (for defining slug test response behavior) refers to the zone where the well water-column level response takes place during testing. For wells having extremely high permeable annular or sandpack zones surrounding the well-screen completion, the measured in-well test response actually represents water-level changes occurring inside the well screen and surrounding sandpack. In these situations, Bouwer (1989) recommends that the r_c term be replaced in the analysis equations with an effective well radius, r_{ef} , which represents the total *free-water area*, which can be calculated from the total surface area within the well screen and the effective sandpack area that is reflective of the sandpack thickness and porosity, n . The effective well radius, r_{ef} , that represents this total free area, can be calculated with the following equation presented in Bouwer (1989):

$$r_{ef} = [(1-n)r_c^2 + nr_w^2]^{1/2} \quad (3.3)$$

The calculated r_{ef} term shown in Equation 3.3 was utilized for the analysis of all KR-4 injection well tests. Based on the well dimensions and an assumed porosity, n , of 30 percent, an effective radius of 0.0757 m is indicated and used in the pre- and post-test analysis.

A more detailed discussion on the use, analysis and interpretation of multi-stress slug test characterization is also provided in Spane and Newcomer (2004).

3.3 Test Radius of Investigation

As discussed in Spane (1996), the radius of investigation (i.e., the distance that the test response propagates) of slug tests within unconfined aquifers is difficult to quantify into general relationships. This is due to the fact that the distance that the test pressure applied at the stress well travels into the surrounding formation is influenced by a large number of well and aquifer parameter relationships. These influencing parameters include well/aquifer properties: transmissivity and storativity (elastic storage), well aquifer penetration, vertical anisotropy, wellbore storage/skin, and the resolution characteristics of the pressure monitoring system employed. Relationships presented in Guyonnet, et al. (1993) and Spane (1996), however, can be utilized to provide a general scoping estimate of radius investigated by the KR-4 slug test characterizations. Given assumed aquifer property characteristics for transmissivity (7 to 8 m/day), storativity (1.0E-4 to 5.0E-4), vertical anisotropy (0.01), well/aquifer penetration ratio (0.5), and an assumed pressure resolution capability of 0.02 m, then the stresses applied during pre- and post-injection slug tests are estimated to encompass and characterize an area up to approximately 9 meters from the test well locations. Within this radius of investigation, the slug test response is most sensitive to hydraulic conditions within 2 to 3.5 meters from the test well.

4. Pre-Injection Test Characterization

Multiple slug injection tests were conducted at the four KR-4 injection test wells on May 24, 2005. Because of potential infilling of the well screen with sandpack materials due to the well construction design utilized at the four surrounding injection wells, only slug injection tests were conducted at these well site locations. The slug tests were initiated by rapidly lowering a slugging rod of known volume from completely above to completely below the water table within the well-screen section. Two different size slugging rods were used during the testing program at each injection well to impose different stress levels on the test well-screen section. The stress levels for the two different slugging rod sizes used are calculated to impose a theoretical slug-injection test response of 0.437 m (low-stress tests) and 1.137 m (high-stress tests), respectively within a 0.1016-m inside diameter well-screen.

At extraction well K-126, multiple slug injection and withdrawal tests were also conducted on May 24, 2005. Slug withdrawal tests were permitted at this well site since the well design and previous well pumping/development activities indicated a low potential for well-screen infilling. Because of the larger well casing/screen diameter, the slugging rod used to conduct the low-stress tests at the KR-4 injection wells was not used at extraction well K-126. A larger diameter slugging rod was utilized, together with the large slugging rod used during the KR-4 injection well tests, for performing slug injection and withdrawal tests at well K-126. Two different size slugging rods were used during the testing program at each injection well to impose different stress levels on the test well-screen section. The stress levels for the two slugging rods used are calculated to impose a theoretical slug-injection test response of 0.506 m (low-stress tests) and 0.650 m (high-stress tests) within a 0.1524-m inside diameter well-screen.

All pre-injection slug test characterizations exhibited over-damped, heterogeneous formation

response behavior. As discussed in Section 3.3, the heterogeneous formation test behavior exhibited is attributed to the presence of a very high permeability inner zone (negative skin), which is surrounded by a lower permeability outer zone that is reflective of in-situ aquifer conditions. This high-permeability inner zone is considered to be an imposed, artificial condition attributed to either the well completion design (i.e., well screen/sandpack mesh size) at all KR-4 injection well sites or a combination of well completion design and induced development from extended pumping at the K-126 extraction well site. Figure 4.1 shows a Bouwer and Rice test plot comparison of slug test responses for all KR-4 test wells. As shown, a “double-slope” pattern is displayed, which is produced by the presence of a high permeability inner zone condition and surrounded by a lower permeability outer zone. As indicated, the high permeability inner zone dissipates a high percentage of the applied stress (i.e., 70 to >90%). The presence of the heterogeneous formation condition is more clearly exhibited in the diagnostic slug test dimensionless head and derivative type-curve plot for extraction well K-126, shown in Figure 4.2. In both Figures, the higher permeability inner zone is represented by a more rapid test recovery in comparison to the slower, later recovery rate that is reflective of in-situ formation conditions.

Pertinent test/well site conditions at the time of performing the pre-injection slug test characterization are listed in Table 4.1. Analysis results based on the type-curve and Bouwer and Rice methods are summarized in Table 4.1. Selected analysis figures for each of KR-4 test wells are presented in Appendix A. As discussed in Section 3, hydraulic property values derived from type-curve analyses are considered to provide the best estimates of actual formation conditions.

4.1 KR-4 Injection Wells

Slug test results for all KR-4 injection well sites exhibit a high-permeability, sandpack (inner) zone surrounding the well-screen that “absorbs” (i.e., within 3 secs) ~80 to >90% of the imposed slug stress (Figure 4.1). The established pre-injection response behavior for these wells provides a reliable baseline for assessing any significant degradation in injection well conditions (i.e., inner zone) or formation property conditions (i.e., outer zone) in proximity to the wells that may occur during and following the polysulfide field injection.

Type-curve analysis of the slug injection test results (Outer Zone; Table 4.1), indicate relatively consistent estimates for aquifer hydraulic conductivity suggesting relatively uniform hydrogeologic conditions for most injection wells across the inter-well field test demonstration location (i.e., 6.8 to 8.2 m/day). It should be noted that lower permeability estimate (i.e., 2.2 m/day) for injection well 199-K-135 is considered to have a high-level of uncertainty, due to the high dissipation of stress (i.e., >90%) during slug testing. Bouwer and Rice analysis results (Table 4.1) yielded consistently lower estimates (i.e., ~30% lower) than values obtained utilizing the type-curve analysis method. As noted in Section 3.1, this under-estimate bias has been recognized previously and is consistent with test comparisons for slug test characterizations conducted previously on the Hanford Site (e.g., Spang and Newcomer, 2003).

Because of the rapidity of dissipation of the test response (i.e., ≤ 3 secs), reliable hydraulic property estimates reflective of this artificial, inner zone/sandpack region are not possible for the KR4 injection well sites. Greater than values are provided in Table 4.1, however, solely for

qualitative comparison with calculated outer zone/formation estimates. Selected pre-injection test examples of Bouwer and Rice and type-curve analyses are presented in Appendix Figures A.1 – A.4.

4.2 KR-4 Extraction Well

Because extraction well 199-K126 did not have the same well-screen/sandpack stability concerns as at the four surrounding KR-4 injection well sites (i.e., smaller well-screen slot-opening size), slug injection and withdrawal tests were conducted. The slug injection and withdrawal tests performed at K-126 produced similar test responses and analysis results for outer zone characterizations. This suggests that slug injection tests conducted at the four injection well sites should provide reliable test analysis results for aquifer regions in proximity to these well locations.

As exhibited at the KR-4 injection well sites, slug test results for the central extraction well 199-K-126 also display the presence of a higher permeability, inner zone surrounding the well (Figure 4.2). The inner zone surrounding extraction well K-126, however, extends into the formation beyond the sandpack and is attributed to previous, extended pumping cycles at the extraction well. This extended pumping causes development of an artificial, higher-permeability region surrounding the well due to removal of formational, fine-grained, aquifer materials, and is a common phenomenon at extraction well locations.

Because the inner zone is more extensive, the heterogeneous formation slug test response exhibited at well 199-K-126 can be analyzed using slug test analysis methods described in Spane and Newcomer (2004) for inner and outer zone characterization. Type-curve analyses of slug test results indicate hydraulic conductivity estimates of 18.1 and 6.8 m/day for the inner and outer zones, respectively (Appendix Figures A.5 and A.6). As indicated in Appendix Figure A.5 and Table 4.1), the Bouwer and Rice analysis also yielded lower estimates (i.e., ~25% lower) than inner and outer zone values obtained utilizing the type-curve analysis method.

As an additional (novel), corroborative characterization of hydraulic property conditions at the extraction well K-126 site, available well development drawdown data were combined with converted equivalent slug test response data (Figure 4.3). The slug test conversion procedure is described in Spane and Wurstner (1993) and Spane (1996), and provides predicted, early-time, drawdown responses at the pumped well location. This is a useful approach, since actual pumping drawdown data are commonly unreliable (as was this case), due to frequent flow-rate adjustments at the beginning of well development procedure. The combined converted equivalent slug (early-time) and well-development drawdown data (late-time) can then be analyzed using standard hydrologic pumping test methods (e.g., Spane 1993). The composite analysis of the drawdown plot provides an estimate of 6.8 m/day for hydraulic conductivity for the surrounding aquifer formation. The composite analysis hydraulic conductivity value is identical to the slug test type-curve result and suggests that hydraulic characteristics may be relatively uniform over the scales resolved during the short-term pumping test. The composite analysis value of 6.8 m/day is slightly lower than the *representative range* provided from the KR-4 injection test well slug test characterization (i.e., 7.2 - 8.2 m/day); however, the extraction well K-126 value may be more representative of large-scale, inter-well aquifer conditions.

5. Injection Phase: Bromide Tracer Test and Calcium Polysulfide Injection

This report section provides information pertaining to the design, performance and analysis of a multi-well, forced-gradient bromide tracer test conducted between KR-4 injection well K-135 and extraction well K-126. Because the tracer test was to be conducted prior to injection of the calcium-polysulfide reactant solution, after establishing pseudo-steadystate flow conditions between the extraction and surrounding injection well site locations, a number of design considerations and test predictions are common to both the bromide tracer and polysulfide injection. One of the integral aspects for conducting or predicting the performance of the two tests is selection of an *appropriate* extraction and injection rates for the KR-4 test system. Based on hydraulic property estimates provided by the pre-injection test site characterization, the optimum extraction/injection circulation rate for the polysulfide field test demonstration and initial bromide tracer multi-well test was examined. This assessment was based on an arbitrary test criteria of not exceeding a maximum drawdown at the extraction well location of 50% of the currently available saturated well-screen length (currently $L_p = 4.95$ m). This criterion provides a drawdown "safety" factor of 2, should unforeseen degradation in specific capacity conditions (i.e., drawdown/pumping rate) occur at the extraction well during the field test demonstration.

To perform this assessment, the cumulative drawdown at the extraction well was simulated using the WTAQ analytical model (Moench 1997) and represents the summation of the predicted extraction well drawdown, combined with the extraction well buildup effects produced by the four surrounding injection well locations. Predicted drawdown and buildup effects were obtained using the best estimate of large-scale hydraulic conductivity for the site of 6.8 m/day, which was obtained from the composite well development drawdown and converted equivalent slug test analysis. Other pertinent property and test conditions used in the simulation include:

Vertical Anisotropy, K_v/K_h	=	0.1
Specific Yield, S_y	=	0.15
Extraction Well-Screen Length, L_p	=	4.95 m
Injection Well-Screen Length, L_i	=	7.6 m
Aquifer Thickness, b	=	13.7 m
Injection/Extraction Well Distance, r	=	30.5 m
Extraction Well Rates, Q_p	=	57, 75, 95 L/min (15, 20, 25 gpm)
Injection Well Rates, Q_i	=	$\frac{1}{4}(Q_p)$

Figure 5.1 shows the results of predicted cumulative drawdown at extraction well 199-K-126 as it relates to the 50% available drawdown criteria. As shown, cumulative drawdown essentially "stabilizes" at the extraction well (regardless of pumping rate) after ~2 to 3 days. This stabilization of drawdown is attributed to the cumulative buildup effect imposed by the surrounding injection well locations. Based on this assessment, an optimum pumping/injection circulation rate of 20 gpm is indicated over the expected time-period of the field test demonstration (i.e., ≥ 60 days).

The stabilization of drawdown at the extraction well is best displayed using a drawdown derivative

plot. Figure 5.2 shows a combined cumulative drawdown and drawdown derivative plot for extraction well K-126 for a pumping/circulation rate of 75.7 L/min (20 gpm). As discussed in Spane (1993) and Spane and Wurstner (1993), derivative plots for unconfined aquifer pumping tests characteristically exhibit a “v” or “valley” profile. This typical unconfined profile is exhibited for test times ≤ 0.2 days in the figure. After 0.2 days, the influence of the surrounding injection well buildup begins to be manifest in the derivative plot. Stabilization of extraction well drawdown due to buildup produced by surrounding injection wells is analogous to the presence of a recharge boundary in the pumping test response. On a derivative plot, the presence of a recharge boundary is indicated by a continuously declining derivative trend. Based on the derivative response exhibited in Figure 5.2, essentially stabilized, pseudo-steadystate conditions are established after 2 to 3 days at the extraction well 199-K-126 site. Pseudo-steadystate conditions at surrounding injection well locations take slightly longer (i.e., after ~ 5 days) to establish, since the buildup stress effects of adjacent and opposite injection well locations are imposed at greater distances (i.e., a greater distance than the existing extraction well to individual injection well distance: ~ 30 m).

The previous demonstration of the use of derivative plot analysis for determining establishment of stabilized, pseudo-steadystate conditions indicates that monitoring pressure drawdown responses at extraction well and surrounding injection wells during the course of the field test demonstration can provide direct evidence as to when this condition **actually** occurs. Introduction of conservative (e.g., bromide) and reactive/non-conservative (e.g., polysulfide) tracers at various injection well centers after establishing stabilized drawdown/buildup interwell conditions, greatly simplifies analysis of tracer breakthrough patterns at the extraction well location. Analysis of tracer breakthrough patterns provide transport characterization information (e.g., dispersivity, effective porosity), which can be used to refine the prediction of the areal extent/geometry of the treatment zone created by the polysulfide reagent injection.

5.1 Pre-Test Bromide Tracer Predictions

For guidance in the design and test predictions of a bromide, force-gradient bromide tracer test at the KR-4 field test site, both an analytical and numerical model were employed. The analytical model WELL (Gelhar 1982, 1992) was utilized to qualitatively verify predictive results of the more complex numerically-based Visual MODFLOW Pro model (Waterloo Hydrogeologic, Inc. 2004). The intent was to use Visual MODFLOW (after verification) to simulate tracer conditions for the KR-4 field test demonstration. The analytical model is limited in application to steadystate, force-gradient tracer tests conducted in confined aquifers with fully penetrating wells for test conditions where the longitudinal dispersivity to extraction/injection well distance is relatively small, i.e., $D_l/r \leq 0.1$. The effects of transverse dispersivity, D_t , are not accounted for in the WELL model. Appendix Figure B.1 shows the comparison of analytical and numerical model results for the listed test property/parameter conditions (note: $D_l/r = 0.08$). As indicated, the numerical model predicts slightly faster arrival times, but tracer peak concentration values and recovery limb patterns correlate reasonably well. A possible explanation for the faster numerical model arrival times, may be associated with numerical dispersion caused by the grid-block size used in the

numerical model results (i.e., inter-well, grid-block size = 1.1 m) or due to the limiting assumptions of the analytical model.

A series of field test tracer simulations were generated using the Visual MODFLOW (VM) model (Waterloo Hydrogeologic Inc., 2004) for tracer test design considerations and possible tracer breakthrough scenario patterns at the extraction well location, given the existing injection well location relationships. A four-layer model was employed with the top three layers corresponding to the unconfined aquifer above the Lower Mud unit of the Ringold Formation. The top two layers correspond to the approximate well-screen depths (bottom) of the extraction and injection wells respectively, while the third layer represents the ~lower 45% of the unconfined aquifer not penetrated by the KR-4 test wells. Tracer simulations were based on injecting a 500 gal (1,893 L) tracer volume with a tracer concentration level of 1,000 mg/L (~1.9 kilogram total) at the KR-4 injection well 199-K-135 site at a 5 gpm injection system rate (i.e., 18.9 L/min). A uniform water-table/hydraulic head condition was assumed across the model (i.e., no natural gradient effects). Other pertinent property and test conditions used in the numerical model simulations include:

Horizontal Hydraulic Conductivity, K_h	=	6.8	m/day
Vertical Anisotropy, K_v/K_h	=	0.1	
Effective Porosity, n_e	=	0.05, 0.1, 0.2	
Specific Yield, S_y	=	0.05, 0.1, 0.2	
Longitudinal Dispersivity, D_l	=	2.5, 5.0 10.0	m
Transverse Dispersivity, D_t	=	0.1(D_l)	
Aquifer Thickness, b	=	13.7	m
Injection/Extraction Well Distance, r	=	30.5	m
Extraction Well Rates, Q_p	=	75.7	L/min (20 gpm)
Injection Well Rates, Q_i	=	18.9	L/min (5 gpm)

Appendix Figures B.2 and B.3 show the effects of tracer breakthrough at the central extraction well as a function of dispersivity and effective porosity, respectively. As shown, the overall shape of the tracer breakthrough pattern is largely determined by the interwell dispersivity, while the tracer peak amplitude and arrival time is primarily controlled by the aquifer effective porosity. Examination of the predicted responses also indicates that tracer peak responses may occur over a time period range of 4 to 20 days.

The predicted peak tracer concentrations at the extraction well for these simulations are relatively low, ranging between 0.5 and 1.8 mg/L. This is near the threshold detection capability of the bromide probes to be used in the field test demonstration. These simulations were based on limiting the tracer solution concentration to 1,000 mg/L at the injection well site. The selected tracer concentration was based on concerns of tracer density issues (i.e., sinking) that may adversely affect tracer transport to the point of extraction. Areal and vertical simulation of tracer concentration within the aquifer, however, indicate that the tracer concentration is rapidly diluted within the aquifer a short-time after injection; and therefore, tracer density/sinking issues are likely not relevant for this test condition. Based on these simulations, a higher tracer solution (i.e., ~1500 mg/L) was selected for use in the actual multi-well, forced-gradient tracer test.

It should be noted that the test predictions shown in Appendix Figures B.2 and B.3, do not include the presence of tracer concentration within the re-injected fluid. The impact of including tracer in the re-injected fluid at very small concentration levels (i.e., ≤ 1.0 mg/L) will cause the recovery limb following the tracer breakthrough peak to not decline to non-detection levels as shown in the figures. Instead, the recovery limb should approach and remain relatively constant with the tracer re-injection concentration level. Because of its primary influence on the shape of the tracer breakthrough pattern, the recirculation of tracer at the injection well locations would likely limit detailed resolution of aquifer longitudinal dispersivity based on this type of test.

To provide some insight into the potential areal extent of the calcium polysulfide injection, the numerical model was also run as a continuous injection for the following input parameters:

Horizontal Hydraulic Conductivity, K_h	=	6.8	m/day
Vertical Anisotropy, K_v/K_h	=	0.1	
Effective Porosity, n_e	=	0.1	
Specific Yield, S_y	=	0.1	
Longitudinal Dispersivity, D_l	=	5.0	m
Transverse Dispersivity, D_t	=	0.1(D_l)	
Extraction Well Rates, Q_p	=	75	L/min (20 gpm)
Injection Well Rates, Q_i	=	18.9	L/min (5 gpm)

The simulation is based on a conservative tracer, which polysulfide is not, but provides insight as to the maximum possible areal extent within the unconfined aquifer that the polysulfide might react over various injection times. Appendix Figures B.4 and B.5 show the areal extent of the reactant solution (within the top two model layers) at 1 week and 3 months, respectively, after continuous injection at the four surrounding, injection well centers. A theoretical injection reactant concentration of 100 mg/L was used in the simulations. Isochron contours shown, therefore, can be viewed as numeric percentages of the initial reactant concentration. As shown, the area occupied by the reactant solution is rather extensive, even utilizing rather conservative values for longitudinal and transverse dispersivity.

5.2 Bromide Tracer Test: Observations/Analysis

The pre-test simulations for bromide tracer breakthrough discussed in Section 5.1, identified a number of test design considerations that would maximize resolving the hydraulic and transport property characteristics over the inter-well test distance. These test design considerations included: appropriate constant extraction/injection well rates (75.7 L/min/18.9 L/min), approximate bromide tracer pulse concentration (~1,500 to 2,000 mg/L), and time for establishment of pseudo-steadystate gradient conditions (3 to 5 days) prior to bromide tracer injection. Schedule and test facility constraints, however, limited implementation of these design considerations, specifically as they relate to: establishment of a pseudo-steadystate condition prior

to bromide tracer injection, and maintenance of constant optimum extraction/injection rates.

The KR-4 extraction/injection well pumping system was tested briefly on June 26, 2005 to check for surface piping system leaks, valve settings, and pumping performance. In all, ~15,500 L were pumped from the central extraction well K-126, with varying amounts re-injected at the individual, surrounding injection well locations. Formal operation of the KR-4 test began at approximately, 0830 hrs PDT on June 27, 2005 when pumping was initiated at extraction well K-126 at ~94.6 L/min. The pumped water from the extraction well was diverted to a surface reactant tank (capacity = 20,820 L) that is used to deliver water to the surrounding injection well locations. At approximately 1000 hrs PDT, water was diverted from the surface reactant tank to the four KR-4 injection well sites, utilizing the designed surface closed-piping delivery system. Surface transfer rates to the injection well sites were variable during this initial time period, as flow balancing efforts were attempted through manual valve setting adjustments. Between 1019 and 1115 hrs PDT on June 27, 2005, 1,590 L of bromide tracer was injected into injection well K-135. The average concentration of the bromide tracer solution injected at well K-135 was 1,420 mg/L, as determined from laboratory analyses of injection solution samples. By 1131 hrs, water was re-directed to all four KR-4 injection wells and balancing of injection rates was again attempted utilizing manual valve adjustments. Pumping/injection circulation at the KR-4 test site continued until 1830 hrs, when the test system was shut-down. Pumping/injection resumed at 0600 hrs PDT on June 28, 2005, and the calcium polysulfide reactant solution (29% solution) was mixed with the pumped water in the surface reactant tank creating a 7% calcium polysulfide solution that was injected via the closed-pipe delivery system to the four injection wells. Delivery of the mixed calcium polysulfide solution to the injection well locations commenced at ~0830 hrs on June 28, 2005 and continued to August 10, 2005. Injection and circulation of the polysulfide reactant solution during this period was not continuous, with frequent, extended idle periods being recorded for system maintenance.

Bromide concentration levels within the groundwater pumped from extraction well K-126 were monitored continuously in the field utilizing an in-line, bromide-specific ion-electrode sensor, and discretely through periodic samples collected from well K-126 discharge water prior to delivery to the surface reactant tank. The bromide probe/sensor was calibrated in the laboratory with standards of known bromide concentration prior to the field test. Because of the interference effects produced by the polysulfide solution, the field readings provided by the in-line bromide probe were designed to only provide qualitative information concerning the initial bromide tracer arrival. Quantitative bromide tracer concentration/mass determinations were provided by laboratory analysis of the discrete samples collected directly from groundwater pumped from extraction well K-126 through the course of the KR-4 calcium polysulfide field demonstration. Discrete samples were collected periodically over 24 days, following initial injection of the bromide tracer solution.

Figure 5.3 shows well K-126 bromide concentration results obtained from the laboratory analysis of the collected discrete samples. Examination of the bromide tracer profile in Figure 5.3 exhibits several distinct arrival features:

- An initial tracer arrival peak occurring between 4 to 5 days

(elapsed test time),

- an overall, observed low tracer return concentration, and
- a relatively uniform tracer recovery-limb plateau concentration level, following the arrival peak

The arrival of the initial tracer peak falls within the lower range (i.e., more rapid arrival) predicted in pre-test simulations (Section 5.1; Appendix Figures B.2 - B-3) for the transport parameter ranges examined under homogeneous formation conditions. In addition, the overall and peak tracer concentration (i.e., ≤ 0.30 mg/L) observed at the extraction well is near the lower range predicted. Aquifer heterogeneity or layered vertical variation of hydraulic and transport properties may contribute to faster tracer arrival times and lower (attenuated) tracer concentrations at the partially-penetrating, extraction well K-126 location. Although the previous simulation suggested that density issues were likely not important, tracer-density/aquifer sinking conditions at the injection well could also have contributed to lowering the concentration of tracer observed at the pumped well, due to longer flow paths, and deeper aquifer circulation.

The relatively uniform tracer concentration (i.e., 0.20 to 0.24 mg/L) observed for the recovery limb following the peak tracer arrival is expected, due to the re-injection of tracer at the injection well locations. As noted previously, the pre-test tracer predictions did not account for the presence of tracer within the re-injected reactant solution. The slight oscillations in tracer concentration over the 24-day monitoring period may be attributed to the re-arrival or "echo" effect of the tracer peak during the field demonstration.

As indicated in Section 5 and Appendix B figures, the observed tracer arrival time and its associated breakthrough/recovery pattern are significantly influenced by the existing interwell transport property conditions (i.e., dispersivity, effective porosity). To resolve these transport characterization parameters, however, requires that the multi-well test be conducted in a **controlled** test manner. As noted previously, the fact that the tracer was injected prior to establishment of pseudo-steadystate conditions and that the extraction/injection was not conducted either continuously or uniformly makes detailed quantitative analysis highly questionable. In addition, the fact that the extraction and injection wells do not fully penetrate the aquifer and are completed at different aquifer depths greatly restricts resolving and estimating effective porosity and dispersivity from the tracer arrival/breakthrough pattern analysis. This is due to adding the influence of aquifer vertical anisotropy ($K_D = K_v/K_h$) to the tracer analysis, imposed by the partially penetrating well conditions.

In spite of these analytical short-comings, a scoping analysis of the observed bromide tracer pattern at extraction well K-126 was attempted utilizing the same homogeneous aquifer, numerical model employed for pre-test, tracer predictions. Daily cumulative well/flowmeter data logs were consulted to generate a general pumping/injection rate schedule for the KR-4 test system during the initial 30-day period. To simplify the modeling analysis process, injection rates were assigned to be equal for all four KR-4 injection wells and to be $\frac{1}{4}$ that assigned at the extraction well location. Based on these simplifying analysis assumptions, the following extraction/injection well

schedule was adopted for the numerical analysis:

<u>Elapsed Test Time</u> <u>days</u>	<u>Extraction Well</u> <u>Rate, L/min</u>	<u>Injection Well</u> <u>Rate, L/min</u>	<u>Injection Well Tracer</u> <u>Concentration, mg/L</u>
0.0 - 0.344	122.65	30.66	0
0.344 - 0.990	0	0	0
0.990 - 6.181	81.77	20.44	0.13
6.181 - 14.993	0	0	0
14.993 - 17.156	98.12	24.53	0.22
17.156 - 23.167	0	0	0
23.167 - 24.969	109.02	27.26	0.24

The only addition to this schedule was applied at the injection well K-135, where the bromide tracer pulse was administered. For this injection well site, the tracer (1,420 mg/L) was accounted for in the model between an elapsed test time of 0 to 0.038 days, at an injection rate of 40.88 L/min. For other modeled times, injection rates and tracer concentrations for this well site are as shown above for all injection well locations.

Figure 5.4 shows the results of a numerical analysis match utilizing the following hydraulic and transport input parameters: $K = 7.3$ m/day; $K_D = 0.1$; $n_e = 0.17$; $D_1 = 45$ m; and, $D_2 = 4.5$ m. Diffusion and natural hydraulic gradient effects were not accounted for in the analysis and impose little effect on tracer transport, due to the predominant influence that advection has under forced-gradient test conditions. As shown in the figure, the overall shape and basic tracer concentration pattern are duplicated in the simulation, based on these assumed input parameters. As discussed previously however, this solution is not unique, i.e., other combinations of hydraulic and transport parameters yield similar results utilizing the homogeneous aquifer model approach. The values for K , K_D , and n_e are considered reasonable given previously calculated or assumed values for the site, while the value D_1 falls within the upper-most range previously reported in Gelhar et al. (1992) for unconsolidated, alluvial aquifers having test scales similar to the KR-4 field test demonstration. The seemingly high estimate value for D_1 may be an artifact of utilizing or forcing a homogeneous formation model solution to a heterogeneous formation test condition; where an unaccounted, higher permeability layer(s) may be present to provide for faster tracer arrival times to the extraction well location. Since the pre-injection test characterization did not include test methods for determining the vertical distribution of hydraulic properties for the various layers (e.g., dynamic flowmeter surveys, tracer-dilution tests; see Spane and Newcomer 2004), there is no defensible way to constrain the analysis utilizing a heterogeneous formation approach. The homogeneous aquifer analysis shown in Figure 5.4, however, is believed to provide a reasonable, semi-quantitative representation of hydraulic and transport property conditions over the inter-well distance exhibited at the KR-4 field demonstration site.

To illustrate the sensitivity of the numerical tracer analysis match to varying transport parameter values, a sensitivity analysis series was performed for effective porosity, vertical anisotropy, and longitudinal dispersivity. The results of the sensitivity simulations for the various identified parameters are shown in Figures 5.5 through 5.7. The final analysis solution (shown in Figure 5.4) is also included in the sensitivity figures for comparison purposes. As indicated, from comparing

the sensitivity modeling results, the tracer arrival/breakthrough pattern appears to be more sensitive to the effects of effective porosity (sensitivity parameter range = factor of 2.5), and to a less degree for aquifer vertical anisotropy and dispersivity for the range of input parameters examined.

5.3 Calcium Polysulfide Injection Discussion

As discussed in Section 5.2, the treatment zone was created within the unconfined aquifer by circulating a 7% solution of calcium polysulfide solution between the injection and extraction well locations (Figure 2.1) over a 44-day period between June 28, 2005 and August 10, 2005. In total, ~1,340,000 L (~353,000 gal) of polysulfide reactant solution were circulated between the injection and extract well site locations.

As a means of “visualizing” the areal and vertical extent of the treatment zone at the KR-4 field demonstration location, the same Visual MODFLOW numerical model used in analyzing the bromide tracer test was applied. For this visualization, the total volume of reactant solution was injected continuously over a 30-day period at a test system circulation rate of 31 L/min. The injection rates were assigned to be equal at all four KR-4 injection wells, and to be one-fourth that assigned at the extraction well location, i.e., 7.75 L/min per injection well site. The following hydraulic/storage/transport parameters were utilized in the numerical model runs for assessing the areal and vertical extent of the created treatment zone:

Horizontal Hydraulic Conductivity, K_h	=	7.3	m/day
Vertical Anisotropy, K_v/K_h	=	0.1	
Effective Porosity, n_e	=	0.17	
Specific Yield, S_y	=	0.17	
Longitudinal Dispersivity, D_l	=	10.0	m
Transverse Dispersivity, D_t	=	0.1(D _l)	

The selected hydraulic conductivity, effective porosity, and vertical anisotropy input values are based on the bromide tracer profile analysis, while the value for longitudinal dispersivity is an arbitrary, assumed value (note: this value is lower than the bromide tracer test analysis result, but is considered to be more representative of unconsolidated, alluvial aquifers for the scale of the observed KR-4 test size; see Gelhar et al. 1992). Utilizing a lower longitudinal dispersivity value restricts the simulated “spread” of the reactant solution within the aquifer and, therefore, can be viewed as a conservative measure for areal treatment extent assessment. It should be noted that as for the earlier numerical modeling for the bromide tracer analysis, the polysulfide solution is considered to be conservative within the unconfined aquifer (i.e., no reactions/partitioning) and additionally, no affects for diffusion or reactant density were accounted for in the numerical simulation.

Figure 5.8 shows the simulated areal extent of the reactant solution within the upper-8 m of the unconfined aquifer after completing 30-days of injecting/circulating ~1,340,000 Liters of polysulfide solution. The concentration contours are expressed as percentages of the injected reactant solution concentration. As a volumetric point of comparison, the volume of in-situ

groundwater within a 13.7 m thick unconfined aquifer, having a porosity of 0.25, over a 30 m radius surrounding a central extraction well (K-126) would be ~9,700,000 Liters.

As shown in Figure 5.8, a characteristic "clover-leaf" pattern is developed over the inter-well extraction and injection well region. The lower concentration contours in the vicinity of the K-126 extraction well is, in part, attributed to the wells' partial penetration to aquifer thickness aspect ratio. The pressure profile around an extraction well that partially penetrates the unconfined aquifer causes significant vertical gradients immediately around the well vicinity, which means that the extraction well (i.e., K-126) derives a significant percentage of extracted water from "untreated", deeper sections of the unconfined aquifer. Conversely at the injection well sites, the reactant solution is driven more deeply into the aquifer near the injection well vicinity; however, in the interwell region between the injection and extraction wells, the imposed lateral hydraulic gradient is low with not much reactant movement occurring in the lower section of the unconfined aquifer, in comparison to the overlying well-screened depth horizons (note: the lower the K_v ; the less of the reactant goes below the injection site and more is injected horizontally/laterally from the well-screen section). Figure 5.9 shows a cross-sectional view within the unconfined aquifer (through injection wells K-133 and K-135 and the extraction well K-126) that illustrates the affect of reactant solution distribution imposed by the partial-penetrating KR-4 well conditions.

6. Post-Injection Test Characterization

Multiple post-reactant injection slug tests were conducted at the four KR-4 injection test wells on September 8 and 12, 2005 for the purpose of assessing any well/aquifer hydraulic characteristic changes, associated with the calcium polysulfide solution injection. The slug tests were conducted in identical fashion as the pre-injection tests (e.g., multiple slug injection tests using the same slugging rods/stress levels). Because of the presence of adhering reactant solution and associated chemical products within the wells, the injection well-screen sections were first bailed to remove any suspended material from the injection well water-columns (i.e., ~170 to 190 L), prior to injection well characterization. In addition, injection wells K-134 and K-136 were flushed with clean water during the bailing/development process. Several pictures showing the adhering nature of polysulfide reactant solution within KR-4 injection wells are included in Appendix C.

Because of the presence of the submersible pump, post-injection slug test characterization was delayed at extraction well K-126 until pump removal on December 21, 2005. As during the pre-injection test characterization, multiple slug injection and withdrawal tests were conducted at this well site using identical pre-injection stress levels. The adhering reactant solution was not observed within the extraction well as was observed at the KR-4 injection well sites. For this reason, no pre-test bailing/development was performed at this site prior to the post-injection test characterization.

As for pre-injection testing, all post-injection KR-4 well slug test characterizations exhibited over-damped, heterogeneous formation response behavior. As was discussed previously, the heterogeneous formation test behavior exhibited is attributed to the presence of a high

permeability inner zone, which is surrounded by a lower permeability outer zone that is reflective of in-situ aquifer conditions. This high-permeability inner zone is considered to be an imposed, artificial condition attributed to either the well completion design (i.e., well screen/sandpack mesh size) at all KR-4 injection well sites or to a combination of well completion design and induced development from extended pumping at the K-126 extraction well site.

Figure 6.1 shows formation (outer zone) test comparisons for three KR-4 test sites exhibiting faster, more rapid post-injection slug test recovery patterns. In contrast, Figure 6.2 shows test comparisons for two KR-4 test well sites where post-injection test recovery was slower. If test conditions are identical, then a simple pre- vs. post-injection test response comparison should indicate any permeability changes within the radius of influence investigated by the tests (e.g., a more rapid test response indicative of higher permeability conditions). However as indicated in Equation 3.1, for a given over-damped slug test response (i.e., $CD > 3$ for KR-4 test conditions), changes in well-screen length (L) or well-casing radius where the test response occurs (i.e., r_c or r_{eq}) can produce changes or shifts in slug test response, with no change in formation permeability.

Pertinent test/well site conditions at the time of performing the post-injection slug test characterization and their comparison to pre-injection test conditions are listed in Table 6.1. Of particular note are slight reductions that occurred for well-screen lengths at several KR-4 injection wells, due to infilling that occurred during the reactant solution injection/circulation phase. These slight changes that occurred for well-screen/test interval length were accounted for in the post-injection slug test analyses. For assessing changes in the equivalent well radius, r_{eq} , where test responses occur, a novel test stress-level comparison approach was utilized. The rationale being that if no changes in the equivalent well radius, r_{eq} , occurred during the polysulfide reactant injection/circulation, then pre- and post-injection slug test stress levels, H_o , should be identical. As shown in Table 6.2 however, a comparison of pre- and post-injection high-stress test stress levels indicated that all projected, post-injection stress levels at the KR-4 injection wells were consistently higher (i.e., ~40 to 80% higher). An examination of Equation 3.3, indicates that the only variable (i.e., non-fixed) parameter affecting slug test stress levels would be changes in the surrounding sandpack porosity or pore volume. Reductions in sandpack pore volume would produce higher stress levels for post-injection slug tests. For calculating the post injection equivalent test well radius, $r_{eq-Post}$, a modified form of Equation 3.2 was utilized:

$$r_{eq-Post} = r_{eq-Pre} (H_{o-Pre} / H_{o-Post})^{1/2} \quad (6.1)$$

Table 6.2 shows the basis for calculating the post-injection equivalent well test response radius, $r_{eq-Post}$, for each KR-4 injection well location. To examine the relative magnitude of sandpack porosity changes that might be responsible for the observed, projected, post-injection test stress levels, H_{o-Post} , post-injection porosity values were calculated using a modified form of Equation 3.3. As indicated, in Equation 3.3, since the well-screen, r_c , and well radius, r_w , are fixed, then changes to post- and pre-injection stress levels must be associated with changes in the surrounding sandpack porosity, n . The calculated post-injection sandpack porosity (assumed for pre-injection tests to be = 30%), can be calculated by re-arranging Equation 3.3, and applying the following relationship:

$$n = (r_{\text{eq-Post}}^2 - r_c^2) / (r_w^2 - r_c^2) \quad (6.2)$$

As indicated in Table 6.2, post-injection sandpack porosity values were reduced to a range of ~6 to 13% from the assumed pre-injection value of 30%. Given the adhering nature of the injected reactant solution (see Appendix C pictures), a reduction in sandpack pore volume is highly likely. Also shown for comparison purposes are pre- and post-injection stress levels observed for extraction well K-126. For this extraction well, post-injection stress levels are slightly lower, which indicates a slight increase in the equivalent test well radius. This is consistent with pumping/well development activities, which tends to extend the equivalent test well radius into the surrounding aquifer (as discussed in Section 3.2)

Post-injection test analysis results based on the type-curve and Bouwer and Rice methods are summarized in Table 6.3. Selected analysis figures for each of KR-4 test wells are presented in Appendix D. As discussed in Section 3, hydraulic property values derived from type-curve analyses are considered to provide the best estimates of actual formation conditions.

6.1 KR-4 Injection Wells

Post-injection slug test results for all KR-4 injection well sites exhibit a high-permeability, sandpack (inner) zone surrounding the well-screen that “*absorbs*” (i.e., within 1 to 3 secs) ~70 to >90% of the imposed slug stress. As noted in Section 6.0, the post-injection tests consistently absorbed less of the applied test stresses (i.e., in comparison to pre-injection tests), which is attributed to a reduction of the surrounding sandpack porosity. The rapid transition to the outer zone/formation response during the initial seconds of initiating the post-injection tests, makes characterization of the inner-zone (sandpack) impossible for this testing phase. The consistently higher outer-zone test stress levels, however, makes characterization of in-situ formation conditions more reliable for pre-injection test comparisons.

Type-curve analysis of the post-injection slug test results listed in Table 6.3 (i.e., Outer Zone) indicate overall a slightly lower estimate range than for aquifer hydraulic conductivity than obtained for the pre-injection test values (i.e., post = 2.6 to 7.2 m/day vs. pre = 2.4 to 8.2 m/day). Two of the injection wells (K-134 and K-135) exhibited either no change or slightly higher post-injection vs. pre-injection hydraulic conductivity values, while injection wells K-133 and K-136 exhibit lower post-injection formation estimates. It should be noted that the lower permeability post-injection estimate (i.e., 2.6 m/day) for K-136 is considered to have a higher-level of uncertainty, due to the highest initial dissipation of test stress (i.e., ~87%) exhibited at post-injection test sites. As for pre-injection tests, post-injection Bouwer and Rice analysis results (Table 6.3) yielded consistently lower estimates (i.e., ~20% lower) than values obtained utilizing the type-curve analysis method. Similar post- vs. pre-injection hydraulic conductivity estimate patterns were also obtained for the Bouwer and Rice method comparisons. Three of the injection wells (K-133, K-134, and K-135) exhibited either no change or slightly higher post-injection test values, while injection well K-136 exhibited a lower post-injection formation value. Selected post-injection test examples of Bouwer and Rice and type-curve analyses for the formation/outer zone

are presented in Appendix Figures D.1 - D.4.

6.2 KR-4 Extraction Well

As during the pre-injection test characterization, slug injection and withdrawal tests were performed at extraction well K-126. Very similar post-injection test results were obtained both as a basis of test response and analysis results. As exhibited at the KR-4 injection well sites, slug test results for the central extraction well 199-K-126 also display the presence of a higher permeability, inner zone surrounding the well, which extends into the formation beyond the sandpack. As discussed previously, the extended inner-zone is attributed to extended pumping cycles at this well site that causes development of an artificial, higher-permeability region surrounding the well due to removal of formational, fine-grained, aquifer materials.

The inner- and outer-zones were both characterized at extraction well K-126 site using the same analysis procedure used for pre-injection slug tests. Type-curve analyses of slug test results indicate hydraulic conductivity estimates of approximately 17.5 and 7.0 m/day for the inner and outer zones, respectively (Appendix Figures D.5 and D.6). These values are nearly identical with pre-injection type-curve analysis estimates of 18.1 and 6.8 m/day, respectively (see Table 4.1). As for other KR-4 test characterizations, the post-injection Bouwer and Rice analysis also yielded lower estimates (i.e., ~25% lower) than inner and outer zone values obtained utilizing the type-curve analysis method. The post-injection Bouwer and Rice determined values are essentially identical with the pre-injection derived estimates as shown in Tables 4.1 and 6.3.

7. Conclusions

Comparison of pre- and post-injection slug test analysis results indicate no significant change in aquifer hydraulic properties within the immediate vicinity (i.e., within 2 to 3.5 m) of the KR-4 injection and extraction well locations. Specifically, two KR-4 test wells exhibited no change, while two wells displayed a slight increase, and one well a decrease based on comparison of pre- vs. post-injection test type-curve analysis. Figure 7.1 graphically shows the pre- and post-injection comparison relationship for the KR-4 site. It should be noted that the one KR-4 well exhibiting a decrease in local hydraulic conductivity (i.e., K-136) is considered to have a high-level of uncertainty, due to the high dissipation of test stress level (i.e., ~87%), by the artificial inner, sandpack zone.

Analysis of the multi-well, force-gradient bromide tracer test (between injection well K-135 and extraction well K-126), provides valuable, intermediate-scale, hydraulic and transport characterization information over this inter-well test distance (~30 m). This information can be used to simulate the areal extent of the treatment zone. The fact that the tracer test was not conducted in a *controlled* test manner and that the KR-4 injection and extraction wells do not fully penetrate the unconfined aquifer greatly adds to the uncertainty of the tracer test characterization results. Based on the tracer match and sensitivity pattern analyses, the following best match and parameter ranges are provided for these three parameters: effective porosity = 0.17, range = 0.10 to

0.25; vertical anisotropy = 0.1, range 0.05 to 0.5; and longitudinal dispersivity = 45 meters, range = 15 to 45 meters.

Results from the bromide tracer test parameter characterization were used in a numerical model simulation to “visualize” the areal extent of the treatment zone was created within the unconfined aquifer by circulating a calcium polysulfide reactant solution between the KR-4 injection and extraction well locations. The simulations show areal contour plots that represent percentages of the circulated reactant solution within the unconfined aquifer. It should be realized that the computer simulations just represent reactant solution areal extent and not the extent of treatment (i.e., chemical reactions were not included in the model). Nevertheless, the simulation results do provide information pertaining to the aquifer “contact area” of the circulated reactant solution.

The computer model simulations produce a characteristic “clover-leaf” contour pattern (Figure 5.8) that is developed over the inter-well extraction and injection well region. This areal depiction is representative of conditions within the upper-section (i.e., top 8 m) of the unconfined aquifer. A smaller areal extent is indicated for the lower-section of the unconfined aquifer (not shown). This more limited extent within the lower aquifer is a function of the partially penetrating well/aquifer relationships and the estimated aquifer vertical anisotropy (i.e., $K_D = 0.1$).

As expected, the higher reactant solution percentage contours shown in Figure 5.8 are located in proximity of the injection well locations, while conversely lower reactant percentage contours occur at the central extraction well. The lower concentration contours in the vicinity of the extraction well is, in part, attributed to the wells’ partial penetration to aquifer thickness aspect ratio, which causes significant vertical gradients immediately around the extraction well location. The presence of vertical gradients means that the extraction well (i.e., K-126) derives a significant percentage of extracted water from deeper, “untreated” sections of the unconfined aquifer. This is shown graphically in Figure 5.9.

8. References

- Bouwer, H. 1989. “The Bouwer and Rice Slug Test – An Update.” *Ground Water*, 27(3):304-309.
- Butler JJ, Jr. 1997. *The design, performance, and analysis of slug tests*. Lewis Publishers, CRC Press, Boca Raton, Florida. .
- Butler, JJ, Jr., EJ Garnett, and JM Healey. 2003. “Analysis of slug tests in formations of high hydraulic conductivity.” *Ground Water*, 41(5):620-630.
- Gelhar, LW. 1982. *The analysis of two-well tracer tests with a pulse input*. RHO-BW-CR-131 P, Rockwell Hanford Operations, Richland, Washington.
- Gelhar, LW. 1992. *WELL: Analysis of two-well tracer tests with a pulse input*. IGWMC – FOS 47 PC, Version 1.0, International Ground Water Modeling Center Software, Golden, Colorado.

Gelhar, LW, C Welty, and KR Rehfeldt. 1992. "A critical review of data of field-scale dispersion in aquifers." *Water Resources Research*, 28(7):1955-1974.

Guyonnet D, S Mishra, and J McCord. 1993. "Evaluating the volume of porous medium investigated during slug tests." *Ground Water* 31(4):627-633.

Hartman, MJ, LF Morasch, and WD Webber. 2005. Hanford Site Groundwater Monitoring for Fiscal Year 2004. PNNL-15070, Pacific Northwest National Laboratory, Richland, Washington.

Jacobs, J., R.L. Hardison, and J.V. Rouse. 2001. "In-situ remediation of heavy metals using sulfur-based treatment technologies." *Hydro Visions*, 10(2):1,4-5.

McMahon, W. 1997. "Technical Memorandum: Updated Predictive Model for the 100-KR-4 Operable Unit Interim Action Pump and Treat." Environmental Restoration Contractor Interoffice Memorandum 044735, from M.H. Sturges to A.J. Knepp, May2, 1997.

Messer, A., P. Storch, and D. Palmer. 2003. "In-situ remediation of a chromium-contaminated site using calcium polysulfide." *Southwest Hydrology*, 2(5):7.

Moench AF. 1997. "Flow to a Well of Finite Diameter in a Homogeneous, Anisotropic Water-Table Aquifer." *Water Resources Research* 33(6):1397-1407.

Peterson, R.E., F.A. Spane, K.B. Olsen, and M.D. Williams. 2002. Evaluation of Potential Sources for Tritium Detected in Groundwater at Well 199-K-111A, 100-K Area. PNNL-14031, Pacific Northwest National Laboratory, Richland, Washington.

Spane, F.A.. and D.R. Newcomer. 2004. Results of Detailed Hydrologic Characterization Tests – FY 2003. PNNL-14804. Pacific Northwest National Laboratory, Richland, Washington.

Spane FA, Jr. 1993. *Selected hydraulic test analysis techniques for constant-rate discharge tests*. PNL-8539, Pacific Northwest Laboratory, Richland, Washington.

Spane FA, Jr. 1996. "Applicability of slug interference tests for hydraulic characterization of unconfined aquifer: (1) Analytical assessment." *Ground Water* 34(1):66-74.

Spane FA, Jr. and SK Wurstner. 1993. "DERIV: A program for calculating pressure derivatives for use in hydraulic test analysis." *Ground Water* 31(5):814-822.

Waterloo Hydrogeologic, Inc. 2004. *Visual MODFLOW Pro*. Version 4.0, Waterloo, Ontario, Canada.

Table 2.1 Pertinent KR-4 Test Well Pre-Injection Completion Depth/Elevation Conditions

KR-4 Test Well	Ground Surface/Brass- Cap Elevation, m, MSL (NAVD88)	Depth Below Brass Cap		Well-Screen Depth Below Ground Surface/Brass Cap, m	Saturated Well- Screen Section, m MSL ^(a) (NAVD88)
		Well Water- Level, m	Well Bottom, m		
199-K-126	140.05	20.78	26.45	19.63 - 25.73	119.27 - 114.32 (4.95) ^(a)
199-K-133	139.54	20.63	29.30	19.23 - 28.56	118.91 - 110.98 (7.93)
199-K-134	140.17	21.23	28.73 ^(b)	19.64 - 28.80	118.94 - 111.44 (7.50)
199-K-135	140.09	21.14	29.61 ^(b)	19.64 - 28.81	118.95 - 111.28 (7.67)
199-K-136	139.74	20.79	27.96 ^(b)	19.50 - 28.68	118.95 - 111.78 (7.17)

(a) Number in parentheses is saturated thickness within the well-screen interval; it reflects the pre-injection conditions at time of slug testing, i.e. water table elevation within well screen minus bottom of well screen or measured depth to well bottom within well screen due to well infilling.

(b) Wells exhibiting well infilling into well-screen section

MSL = mean sea level.
NAVD88 = North American Vertical Datum of 1988.

Table 4.1. Pre-Injection Slug Test Analysis Results for KR-4 Test Wells

KR-4 Test Well	Bouwer and Rice Analysis Method ^(b)		Type-Curve Analysis Method ^(b)		Comments
	Inner Zone K (m/day) ^(a)	Outer Zone K (m/day) ^(a)	Inner Zone K (m/day) ^(a)	Outer Zone K (m/day) ^(a)	
199-K-126	13.4	4.9 (4.7 - 5.0)	18.1	6.8	Heterogeneous formation response
199-K-133	>30	4.8 (4.7 - 4.8)	>40	7.3	Heterogeneous formation response; no definitive inner-zone analysis possible
199-K-134	>40	5.4 (5.3 - 5.4)	>40	7.2	Heterogeneous formation response; no definitive inner-zone analysis possible
199-K-135	>40	1.6 (1.5 - 1.8)	>40	2.2 (2.2 - 2.3)	Heterogeneous formation response; no definitive inner-zone analysis possible
199-K-136	>40	6.2 (6.1 - 6.4)	>40	8.2	Heterogeneous formation response; no definitive inner-zone analysis possible
<p>(a) Assumed to be uniform within the well-screen test section. For tests exhibiting a heterogeneous formation response, outer zone analysis results are considered representative of in-situ formation conditions</p> <p>(b) Analysis methods: Bouwer and Rice (Bouwer 1989); type-curve (Butler 1997)</p>					

Table 6.1 Pertinent KR-4 Test Well Post-Injection Completion Depth/Elevation Conditions

KR-4 Test Well	Ground Surface/Brass- Cap Elevation, m, MSL (NAVD88)	Depth Below Brass Cap		Well-Screen Depth Below Ground Surface/Brass Cap, m	Saturated Well- Screen Section, m MSL ^(b) (NAVD88)
		Well Water- Level, m	Well Bottom ^(a) , m		
199-K-126	140.05	20.78 (+0.01)	26.50 (+0.05)	19.63 - 25.73	119.27 - 114.32 (4.95) ^(a)
199-K-133	139.54	20.62 (-0.01)	28.31 ^(b) (-0.99)	19.23 - 28.56	118.92 - 111.23 (7.69)
199-K-134	140.17	21.16 (-0.07)	27.31 ^(b) (-1.42)	19.64 - 28.80	119.01 - 112.86 (6.15)
199-K-135	140.09	21.12 (-0.02)	29.54 ^(b) (-0.07)	19.64 - 28.81	118.97 - 111.28 (7.69)
199-K-136	139.74	20.90 (+0.11)	27.27 ^(b) (-0.69)	19.50 - 28.68	118.84 - 112.47 (6.37)
<p>(a) Wells exhibiting well infilling into well-screen section; values listed in parentheses represent additional infill over pre-injection condition</p> <p>(b) Number in parentheses is saturated thickness within the well-screen interval; it reflects the post-injection conditions at time of slug testing, i.e. water table elevation within well screen minus bottom of well screen or measured depth to well bottom within well screen due to well infilling.</p> <p>MSL = mean sea level. NAVD88 = North American Vertical Datum of 1988.</p>					

Table 6.2. Post-Injection Slug Test Parameter Analysis Results for KR-4 Test Wells

KR-4 Test Well	Pre-Injection Test Conditions			Post-Injection Test Conditions		
	Projected Stress-Levels ^(a) H_{o-Pre} , m	Equivalent Test Well Radius ^(b) r_{eq-Pre} , m	Calculated Sandpack Porosity, n	Projected Stress-Levels ^(a) H_{o-Post} , m	Equivalent Test Well Radius ^(c) $r_{eq-Post}$, m	Calculated Sandpack Porosity ^(d) , n
199-K-126	0.1404 (0.1376 - 0.1431)	0.1503	NA	0.1215 (0.1214 - 0.1215)	0.1680	NA
199-K-133	0.2463 (0.2451 - 0.2474)	0.0757	30%	0.3564 (0.3339 - 0.3788)	0.0629	13%
199-K-134	0.1992 (0.1980 - 0.2004)	0.0757	30%	0.3474 (0.3389 - 0.3559)	0.0573	7%
199-K-135	0.1047 (0.0930 - 0.1164)	0.0757	30%	0.1509 (0.1479 - 0.1539)	0.0630	13%
199-K-136	0.0801 (0.0761 - 0.0841)	0.0757	30%	0.1431 (0.1229 - 0.1633)	0.0566	6%
<p>NA Not applicable</p> <p>(a) Average projected formation (outer zone) slug test stress levels for high-stress tests; range listed in parentheses</p> <p>(b) Calculated using Equation 3.3; $r_c = 0.0508$ m; $r_w = 0.1143$; $n = 30\%$; for K-126 calculated based on Equation 3.2 and theoretical applied $H_o = 0.650$ m</p> <p>(c) Calculated using Equation 6.1</p> <p>(d) Calculated using Equation 6.2</p>						

Table 6.3. Post-Injection Slug Test Analysis Results for KR-4 Test Wells

KR-4 Test Well	Bouwer and Rice Analysis Method ^(b)		Type-Curve Analysis Method ^(b)		Pre- and Post-Injection Test K Comparison Comments
	Inner Zone K (m/day) ^(a)	Outer Zone K (m/day) ^(a)	Inner Zone K (m/day) ^(a)	Outer Zone K (m/day) ^(a)	
199-K-126	13.5 (13.2 - 13.7)	5.1	17.5	7.0 (6.8 - 7.1)	Nearly identical pre- and post- injection hydraulic characterization results
199-K-133	NA	4.8 (4.7 - 4.9)	NA	6.1	Slightly lower post- injection hydraulic characterization results
199-K-134	NA	5.7 (5.6 - 5.8)	NA	7.2	Identical pre- and post- injection hydraulic characterization results
199-K-135	NA	2.3 (2.2 - 2.3)	NA	2.9 (2.8 - 2.9)	Slightly higher post- injection hydraulic characterization results
199-K-136	NA	2.0 (1.9 - 2.1)	NA	2.6 (2.5 - 2.8)	Lower post- injection hydraulic characterization results
NA Not applicable or analyzable					
(a) Assumed to be uniform within the well-screen test section. For tests exhibiting a heterogeneous formation response, only the outer zone analysis results are considered representative of in-situ formation conditions					
(b) Analysis methods: Bouwer and Rice (Bouwer 1989); type-curve (Butler 1997)					

Figure 2.1. Extraction Well 199-K-129 Location Relationship to 100-K Area Facilities

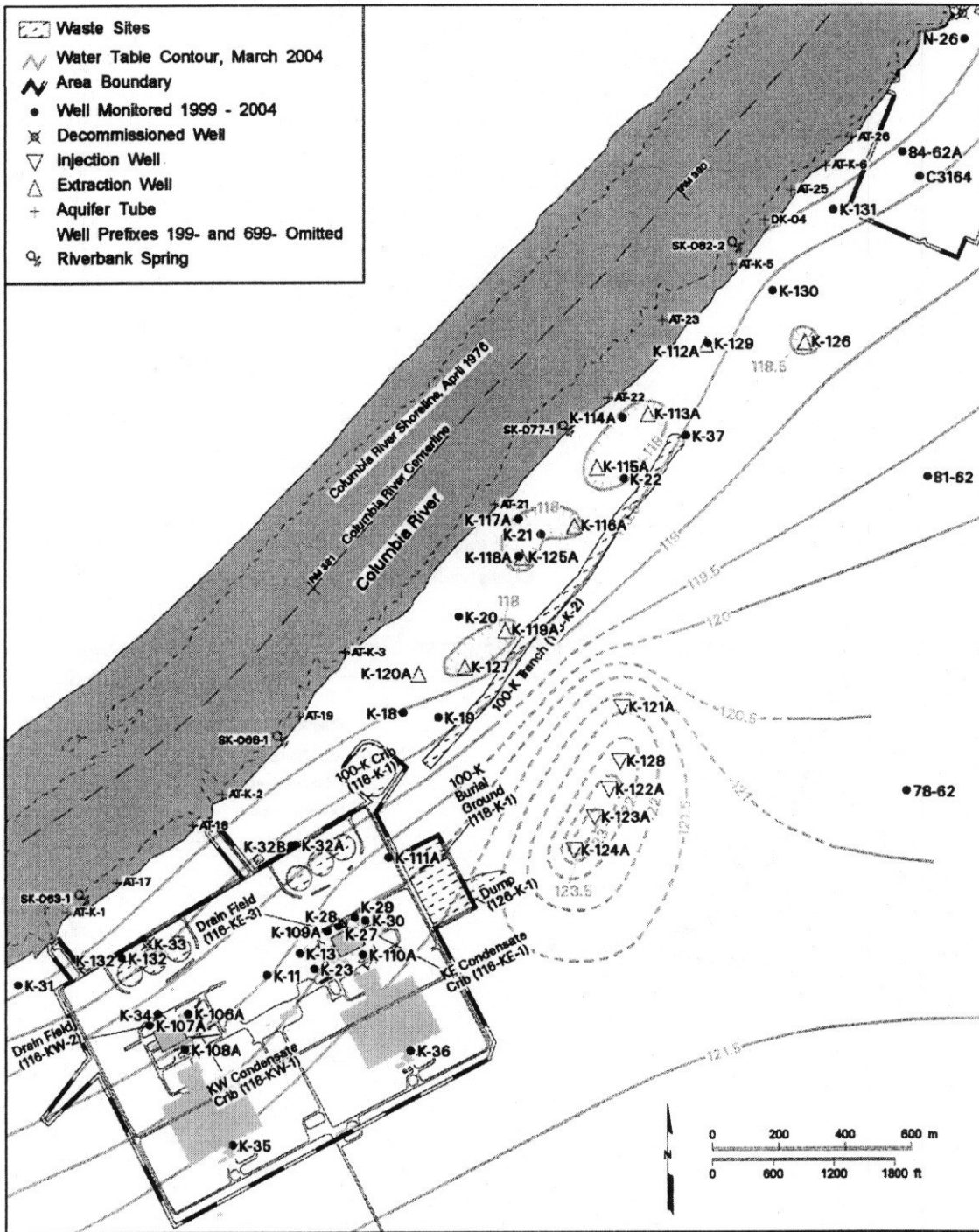

Figure 2.2. KR-4 Test Well Distance Relationships

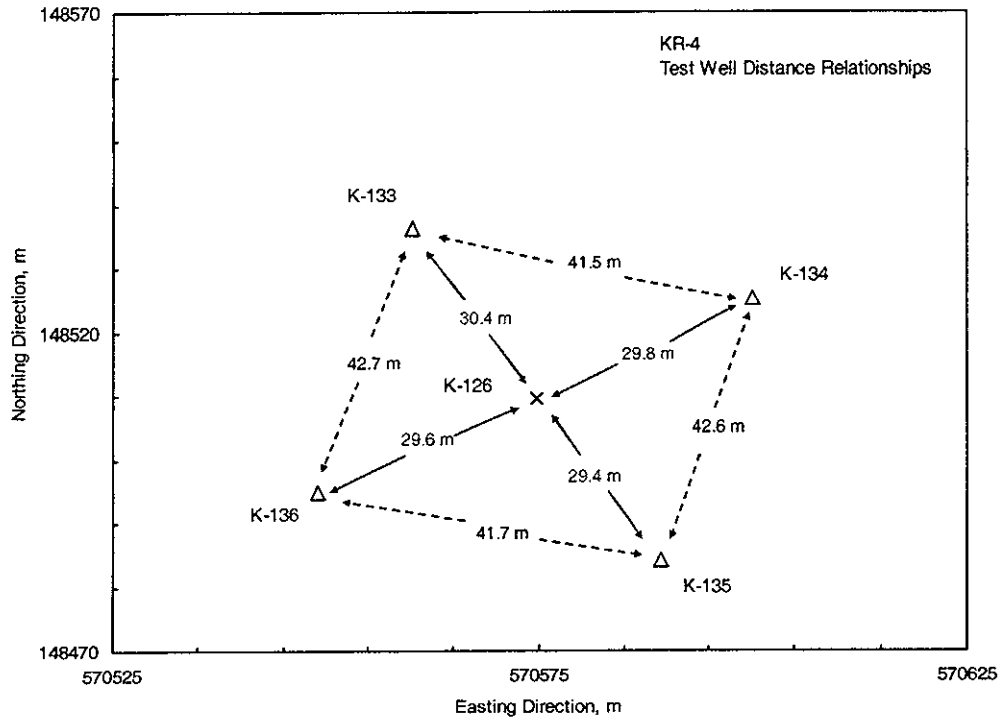

Figure 3.1. Diagnostic Slug Test Response (from Spane and Newcomer 2003)

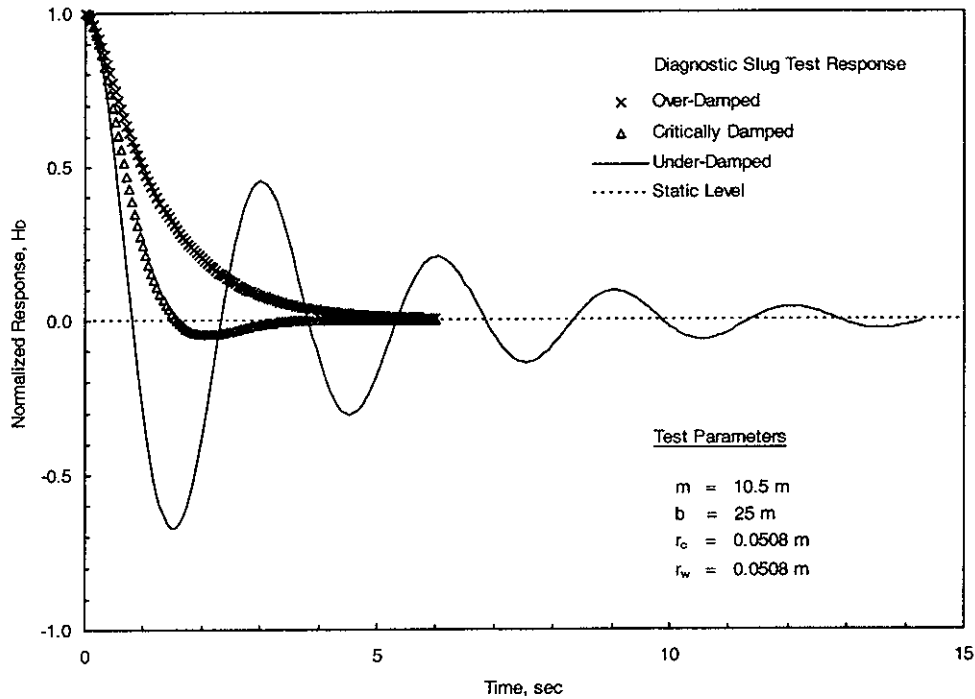

Figure 3.2 Predicted Slug-Test Response: Negative Finite-Thickness Skin Conditions (from Spane and Newcomer 2003)

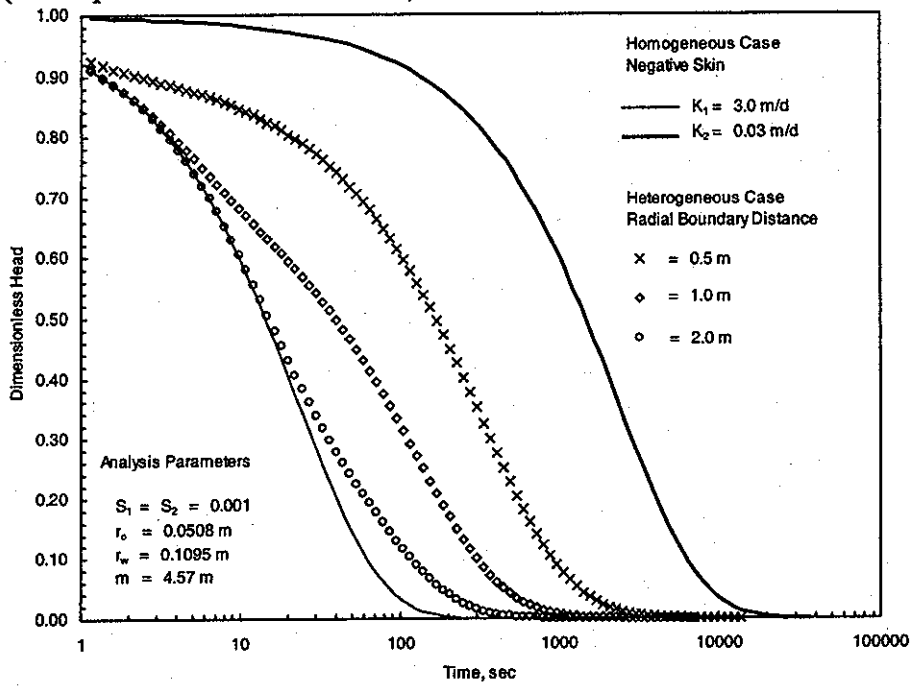

Figure 3.3. Slug-Test Derivative Response: Negative Finite-Thickness Skin Conditions (Spane and Newcomer 2003)

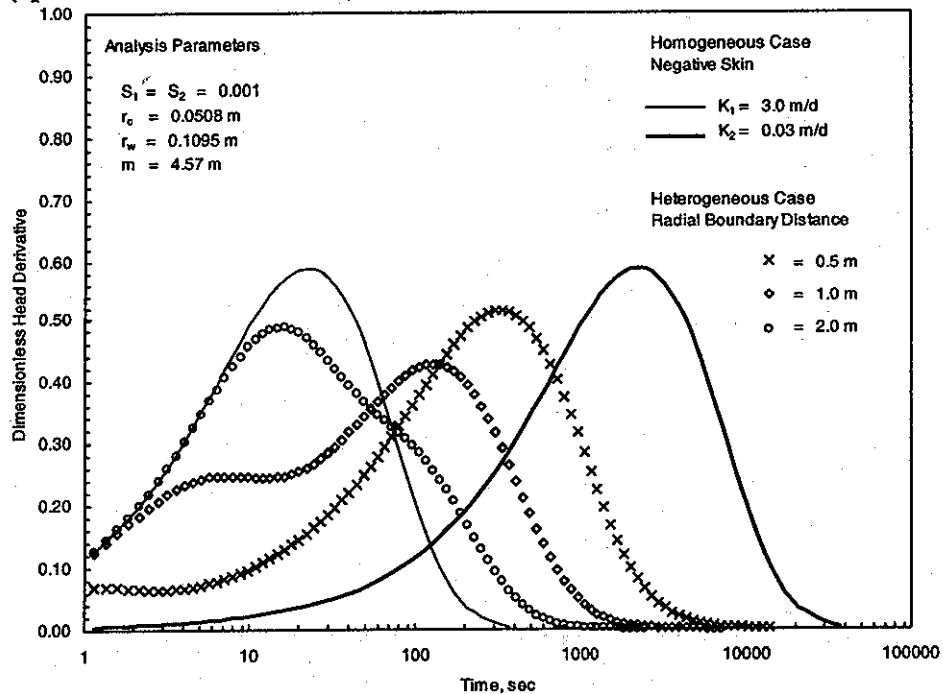

Figure 3.4 Predicted Slug-Test Response: Positive Finite-Thickness Skin Conditions
(from Spane and Newcomer 2003)

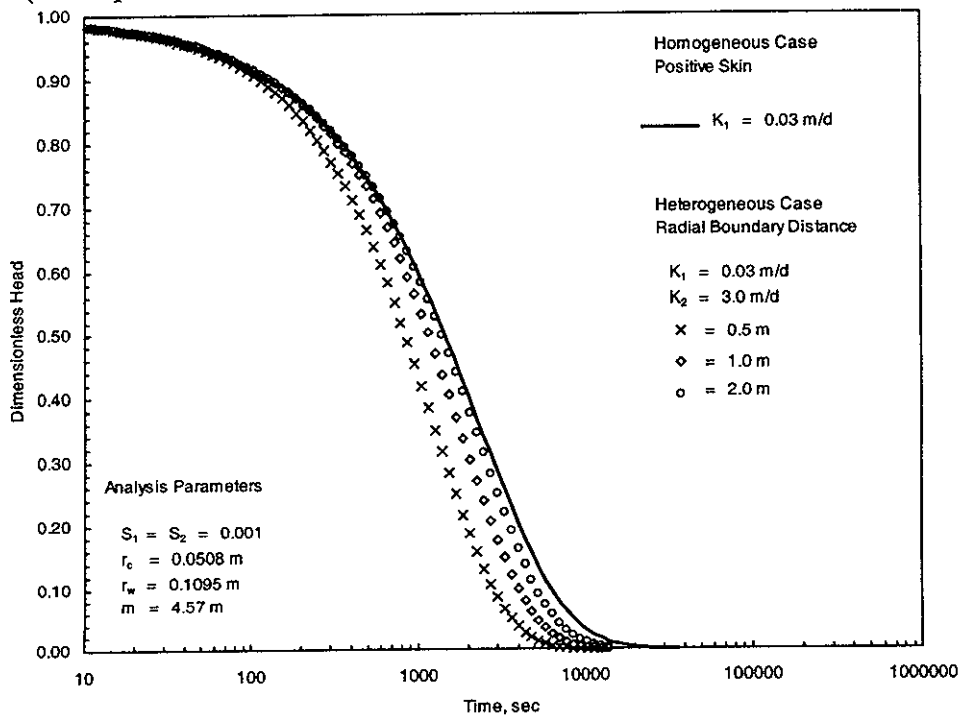

Figure 4.1. Composite Comparison of Pre-Injection Slug Test Responses at KR-4 Test Wells

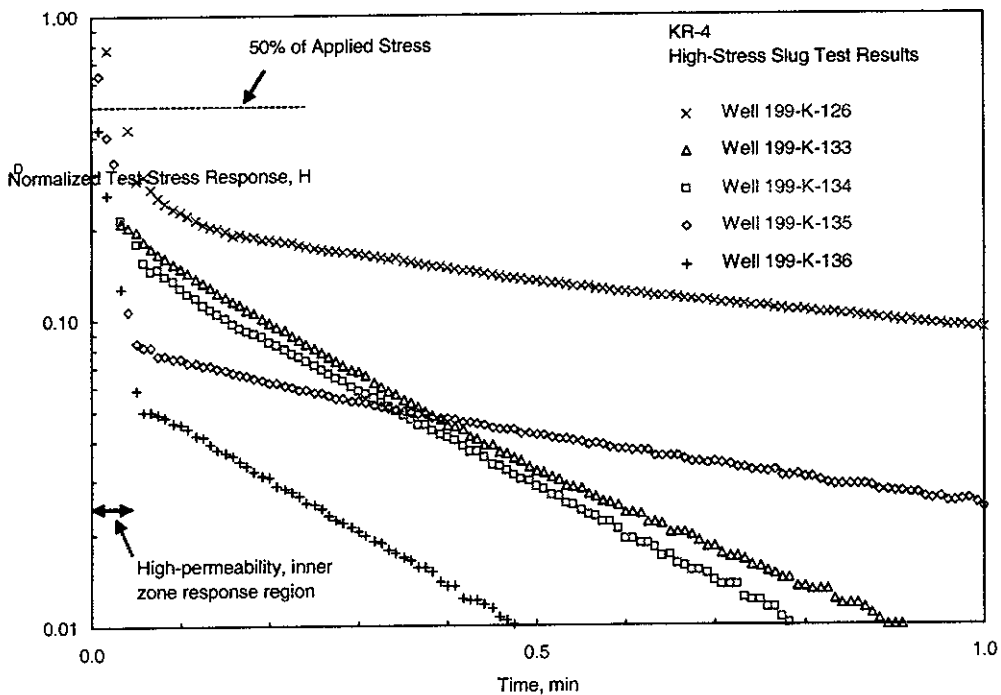

Figure 4.2. Diagnostic Slug Test Analysis – Extraction Well 199-K-126

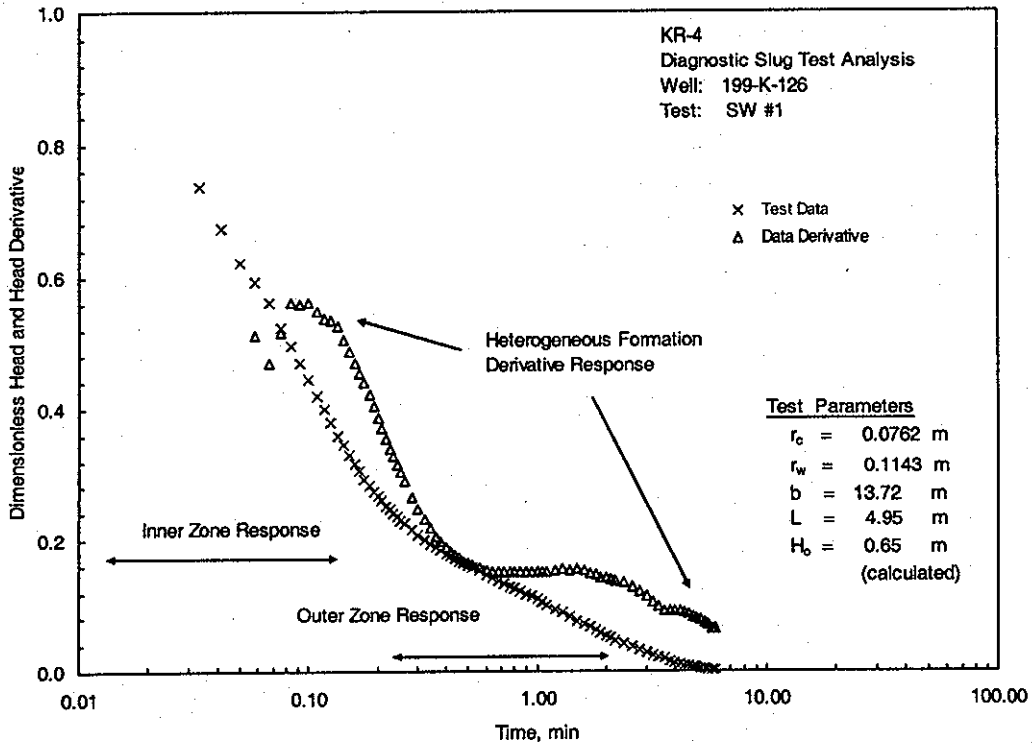

Figure 4.3. Analysis Results of Composite Well-Development Drawdown and Converted Equivalent Slug Test Response Data for Extraction Well 199-K-126

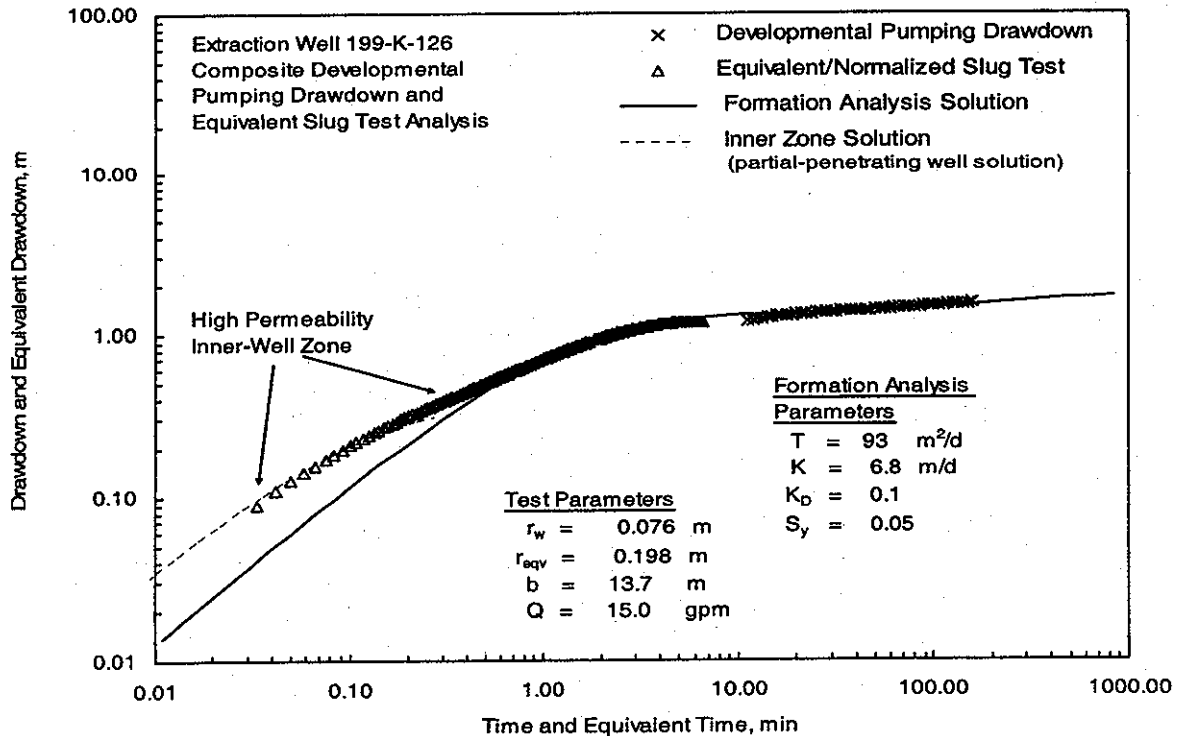

Figure 5.1 Predicted Cumulative Drawdown at Extraction Well 199-K-126 for Extraction Rates: 15, 20, and 25 gpm (56.8, 75.7, and 94.6 L/min)

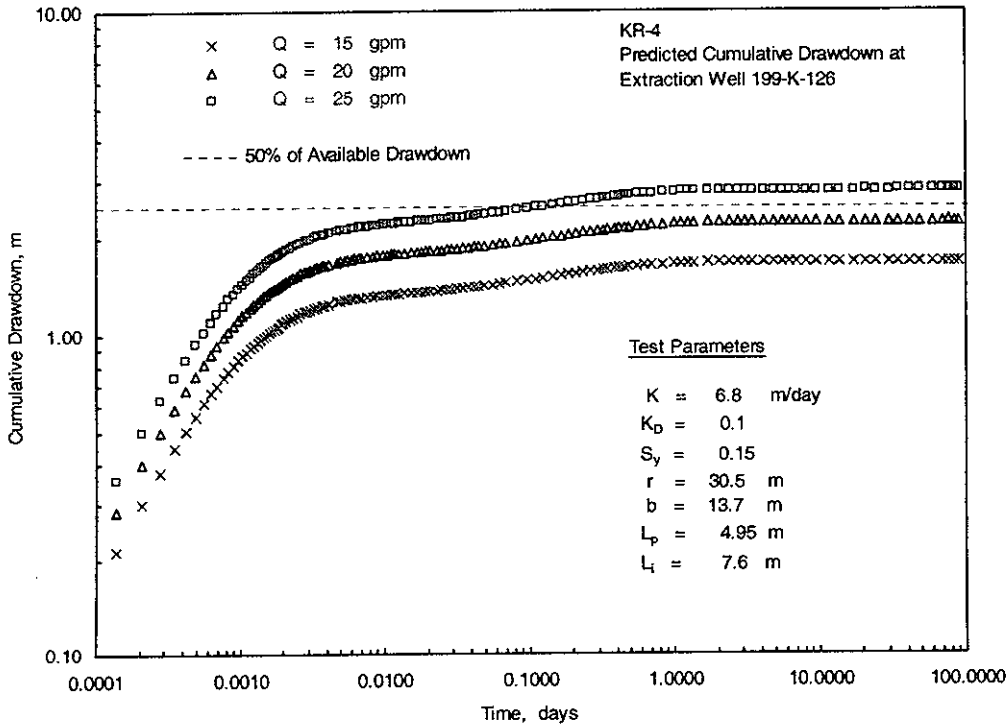

Figure 5.2 Cumulative Drawdown and Drawdown Derivative Plot for Extraction Well 199-K-126: Extraction Rate = 20 gpm (75.7 L/min)

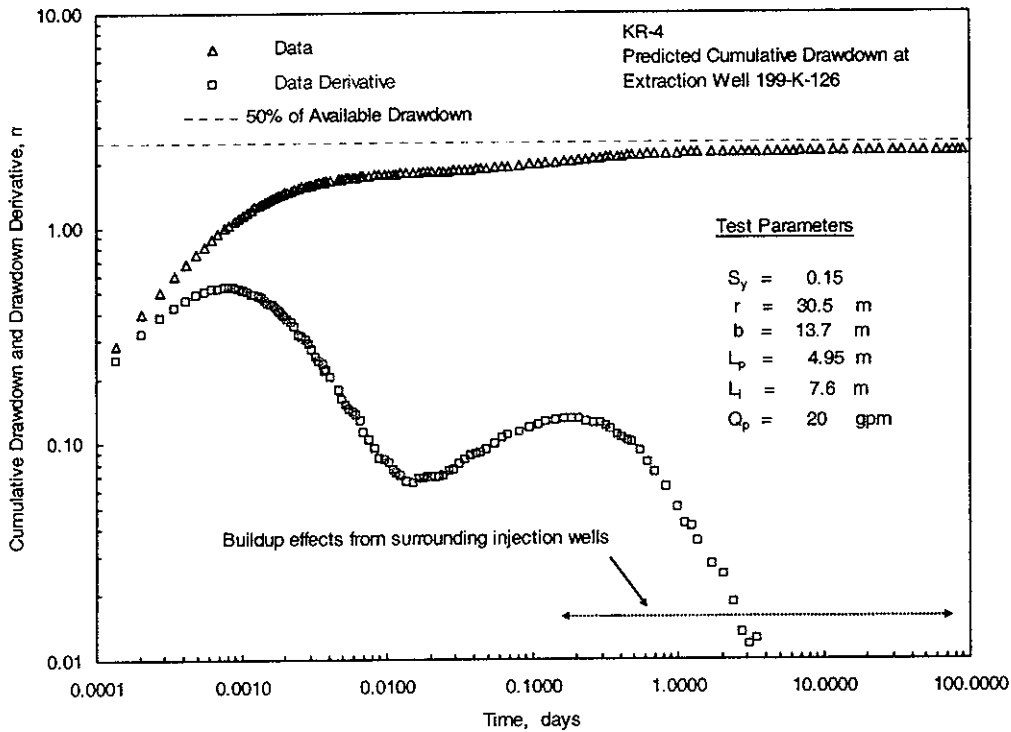

Figure 5.3 Observed Bromide Tracer Concentrations at Extraction Well K-126

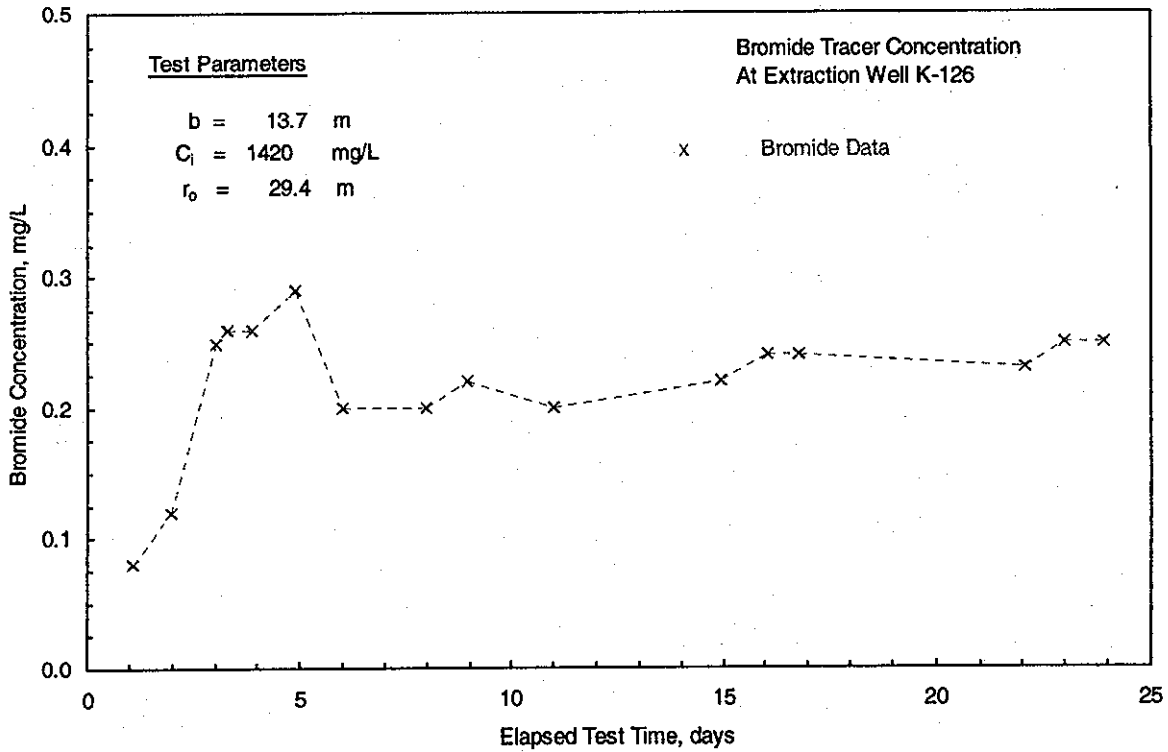

Figure 5.4 Numerical Analysis of Observed Bromide Tracer Concentrations at Well K-126

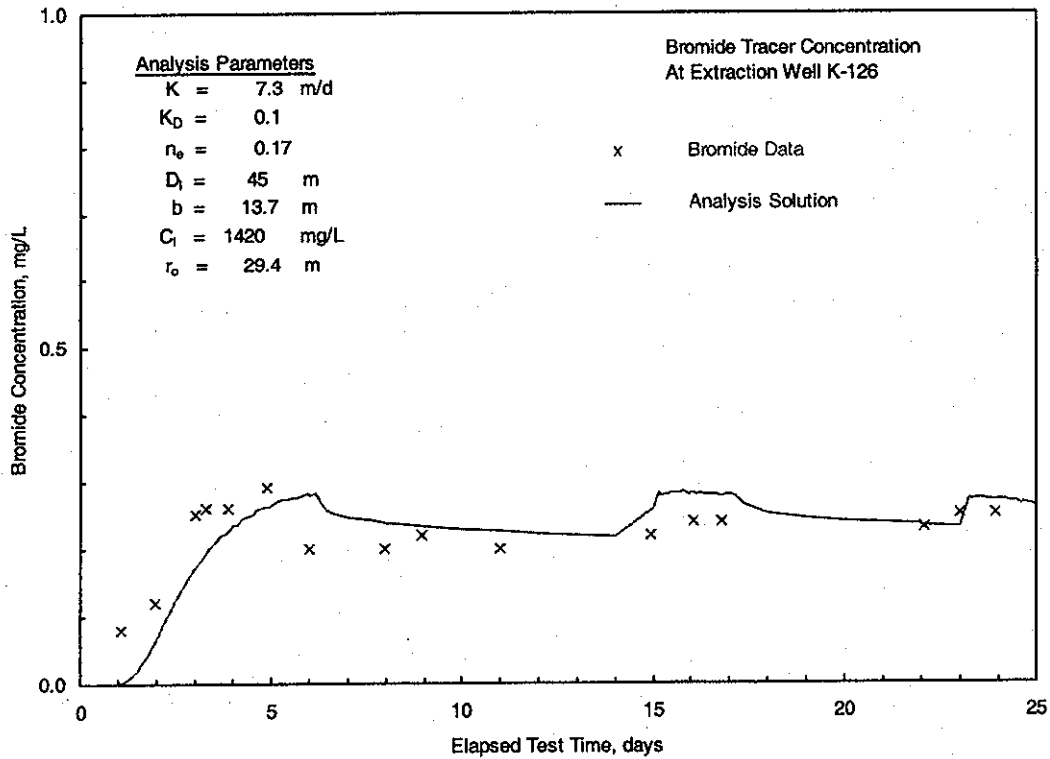

Figure 5.5 Numerical Sensitivity Analysis: Affect of Effective Porosity, n_e

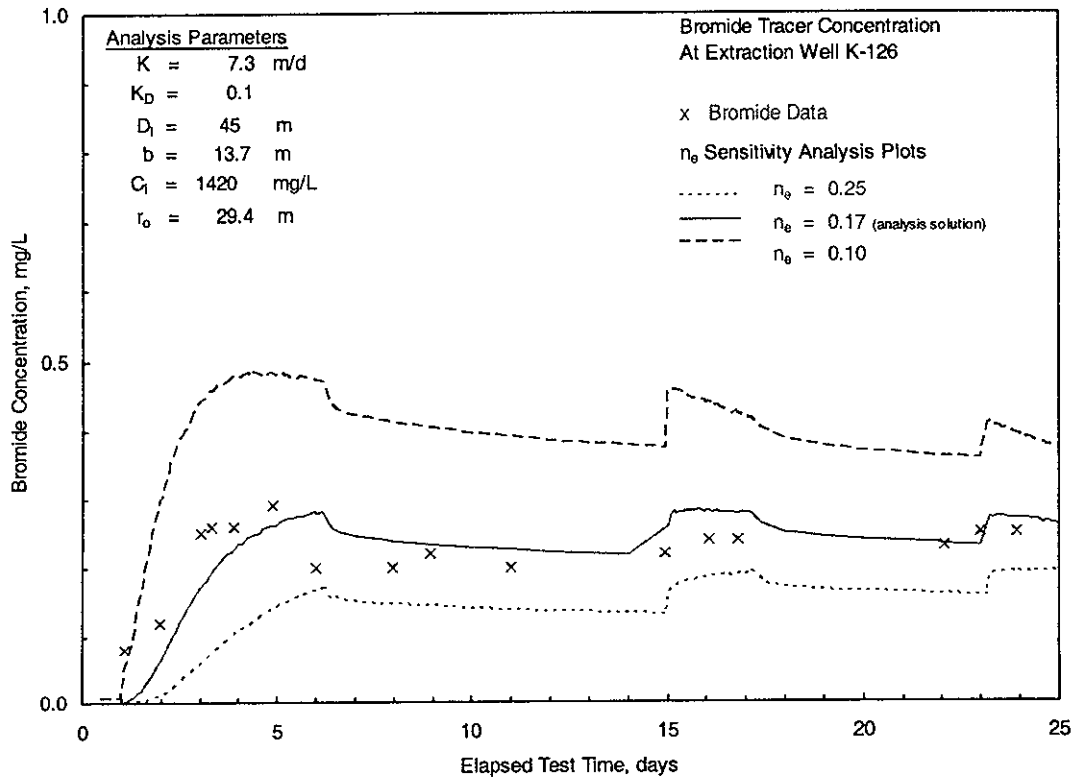

Figure 5.6 Numerical Sensitivity Analysis: Affect of Vertical Anisotropy, K_D

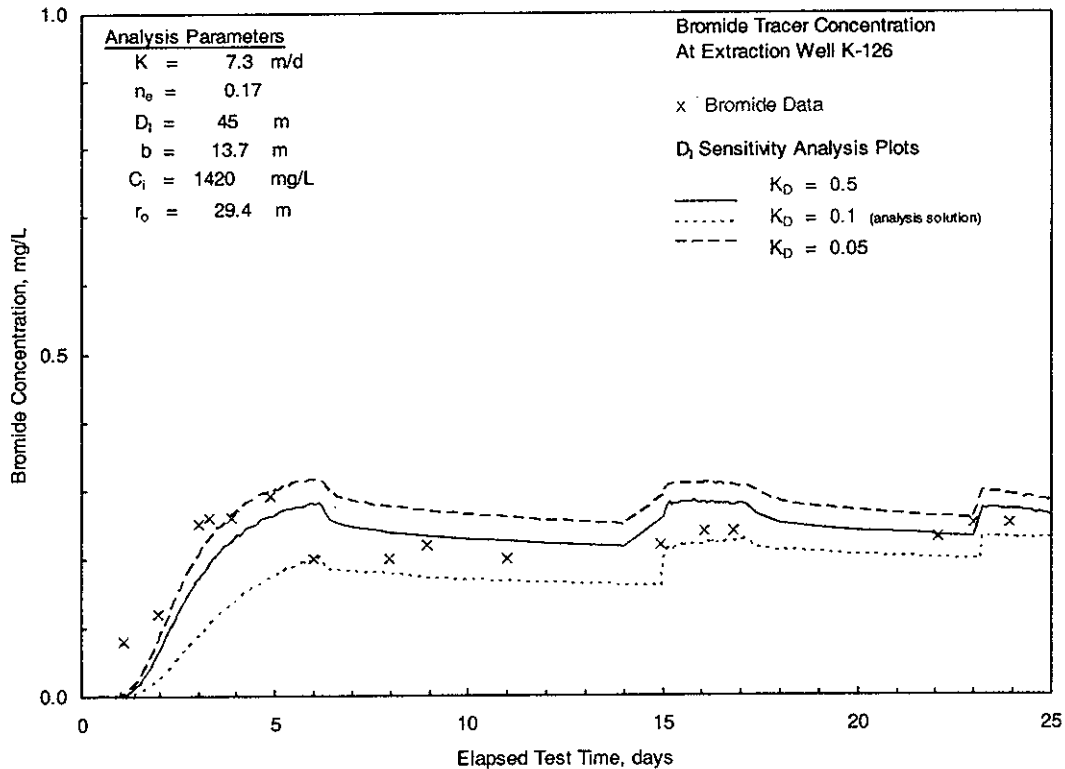

Figure 5.7 Numerical Sensitivity Analysis: Affect of Longitudinal Dispersivity, D_L

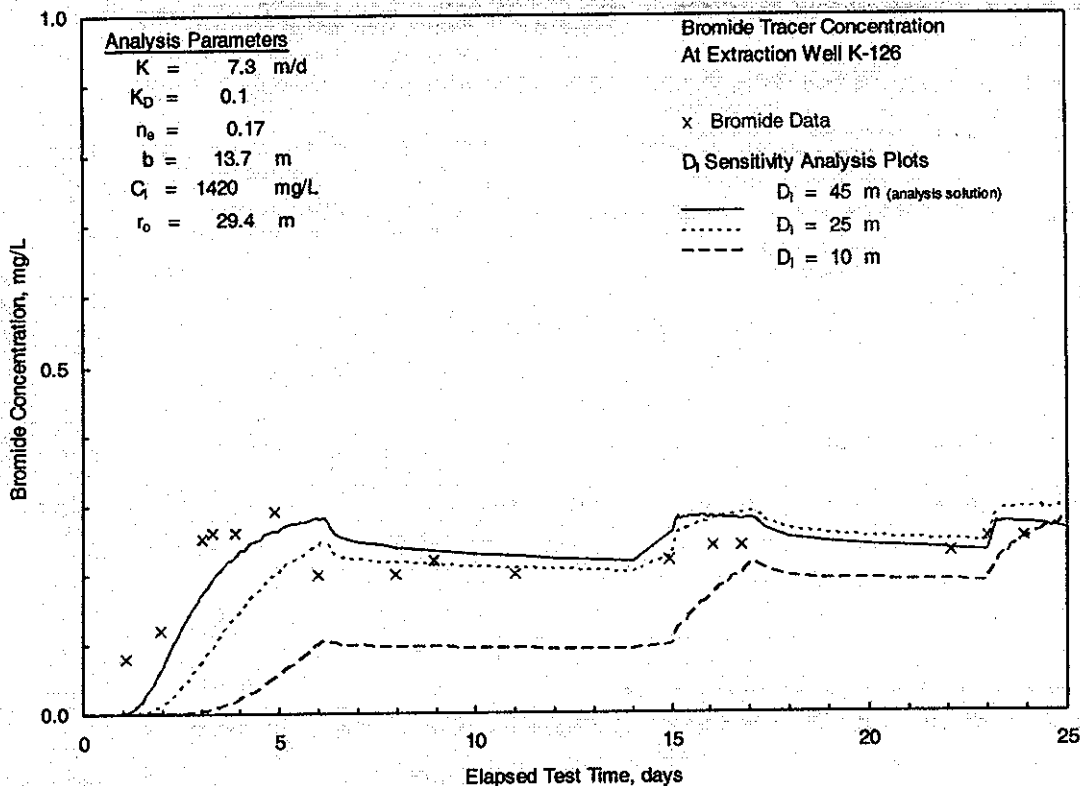

Figure 5.8 View of Areal Extent of Polysulfide Solution Following Multi-Well Circulation

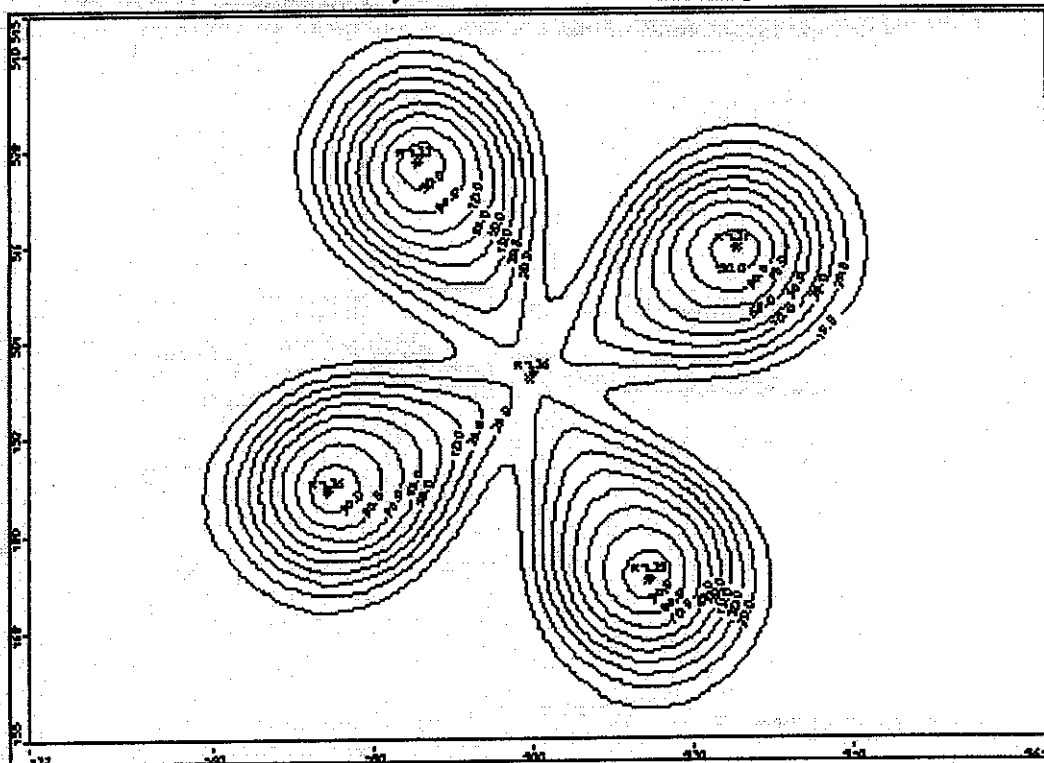

Figure 5.9 Cross-Sectional View of Vertical Extent of Polysulfide Reactant Solution Within the Unconfined Aquifer, Following Multi-Well Circulation

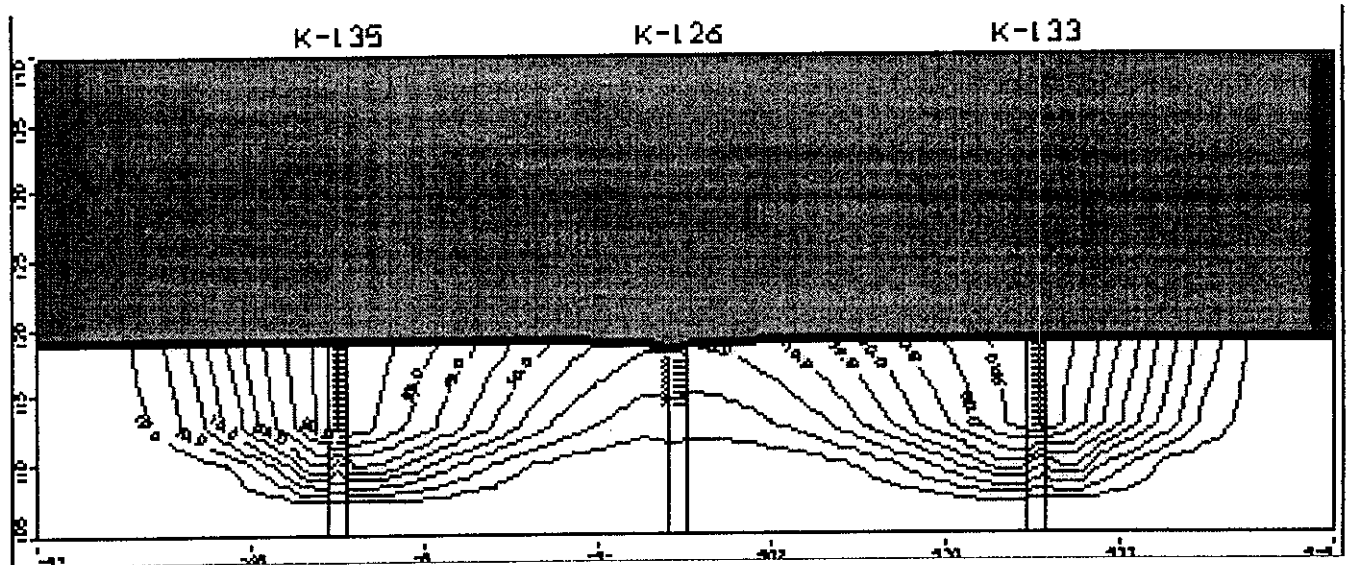

Figure 6.1 KR-4 Test Wells Exhibiting Faster Post- vs. Pre-Injection Slug Test Responses

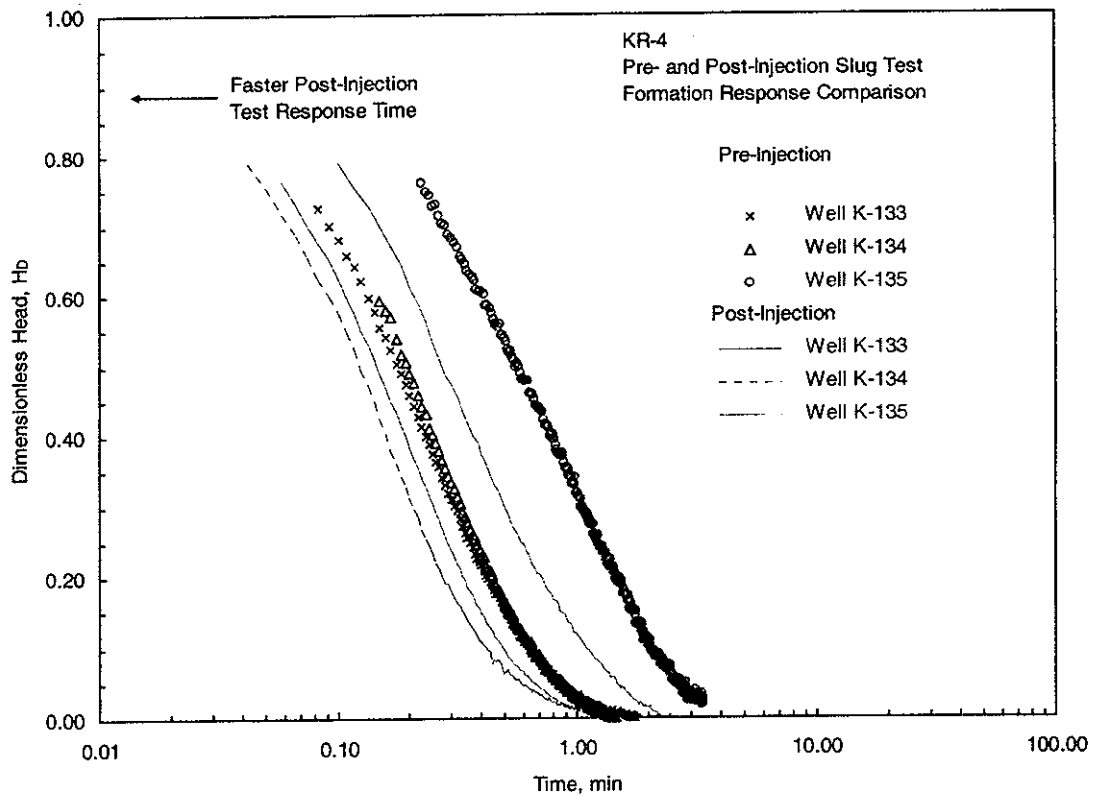

Figure 6.2 KR-4 Test Wells Exhibiting Slower Post- vs. Pre-Injection Slug Test Responses

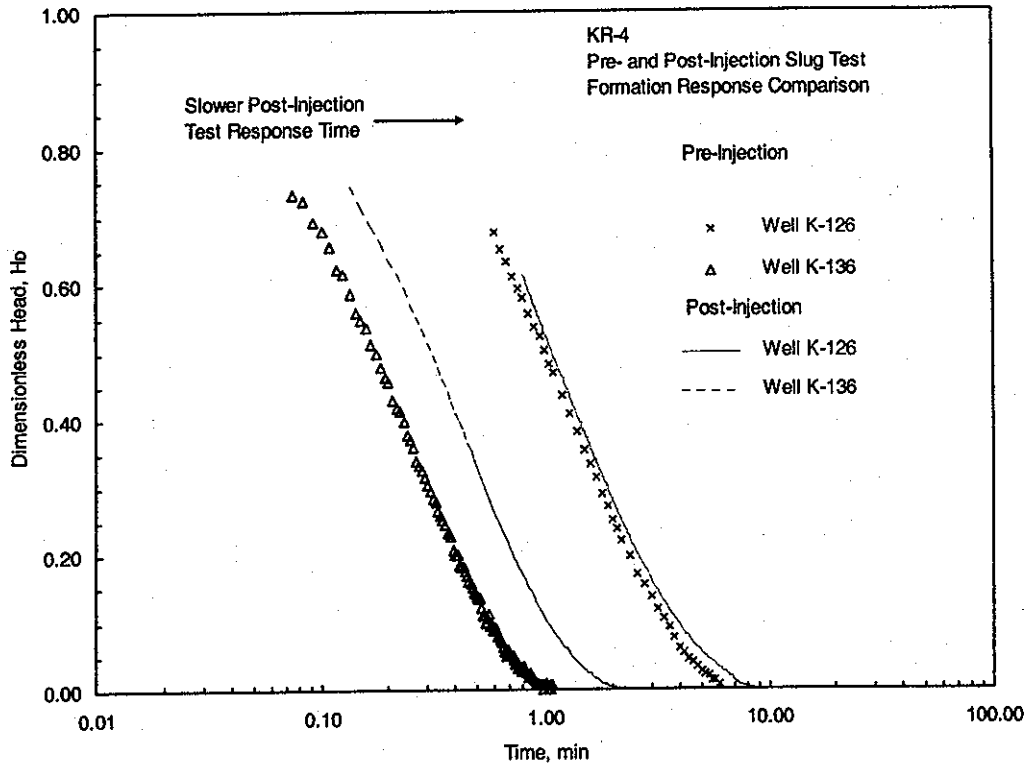
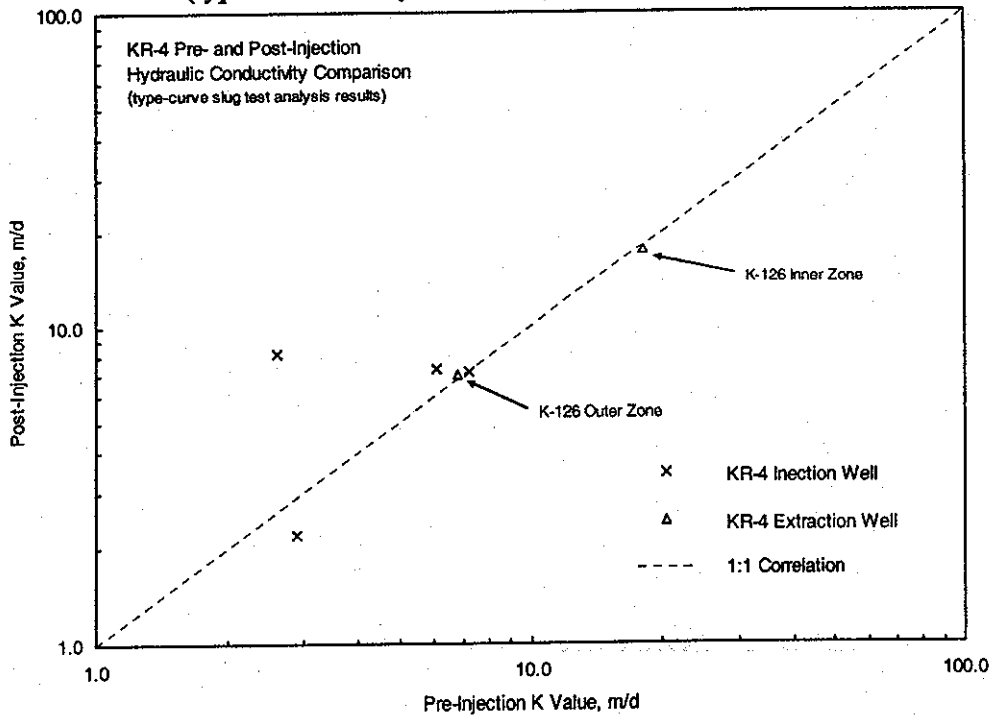

Figure 7.1 Comparison of KR-4 Test Well Pre- and Post-Injection Hydraulic Conductivity Estimates (type-curve analysis results)



Appendix A:

Selected KR-4 Pre-Injection Slug Test Analysis Figures

- A.1 Selected Pre-Injection Slug-Test Analysis Plots for Injection Well K-133 [Bouwer and Rice method (top) and type-curve method (bottom)]
- A.2 Selected Pre-Injection Slug-Test Analysis Plots for Injection Well K-134 [Bouwer and Rice method (top) and type-curve method (bottom)]
- A.3 Selected Pre-Injection Slug-Test Analysis Plots for Injection Well K-135 [Bouwer and Rice method (top) and type-curve method (bottom)]
- A.4 Selected Pre-Injection Slug-Test Analysis Plots for Injection Well K-136 [Bouwer and Rice method (top) and type-curve method (bottom)]
- A.5 Selected Pre-Injection Slug-Test Analysis Plots for Extraction Well K-126 [Bouwer and Rice method (top) and type-curve method (bottom)]
- A.6 Selected Pre-Injection Slug-Test Analysis Plots for Extraction Well K-126: Type-Curve Inner Zone Analysis

Figure A.1. Selected Pre-Injection Slug-Test Analysis Plots for Injection Well K-133 [Bouwer and Rice method (top) and type-curve method (bottom)]

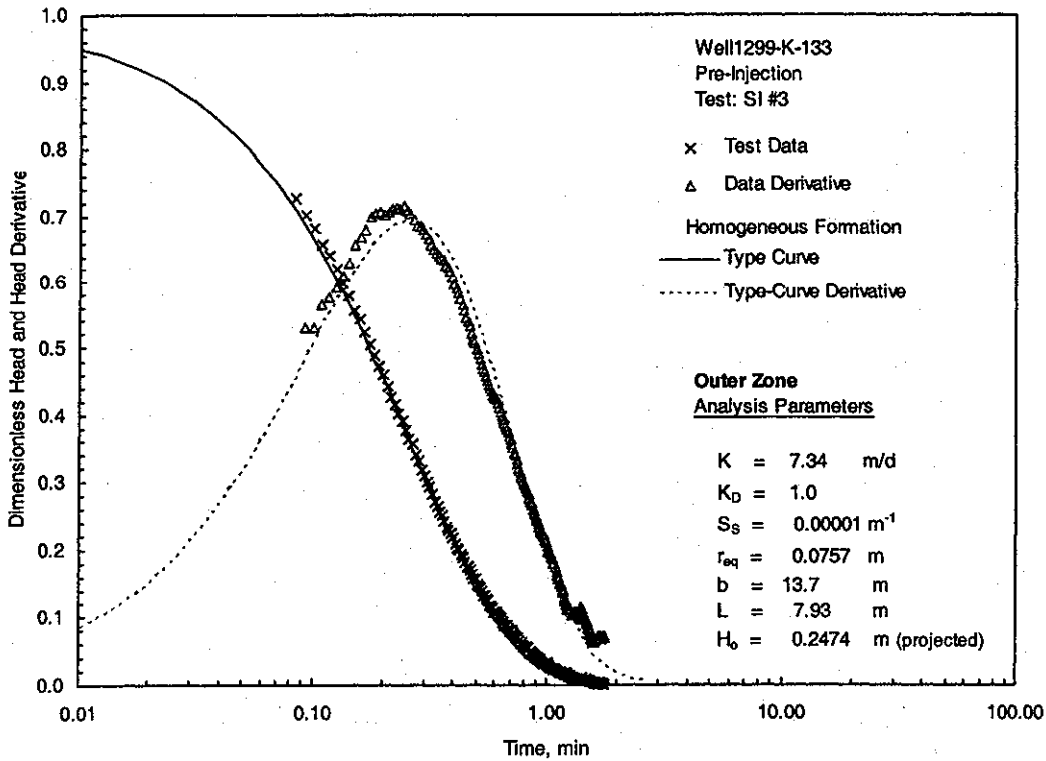
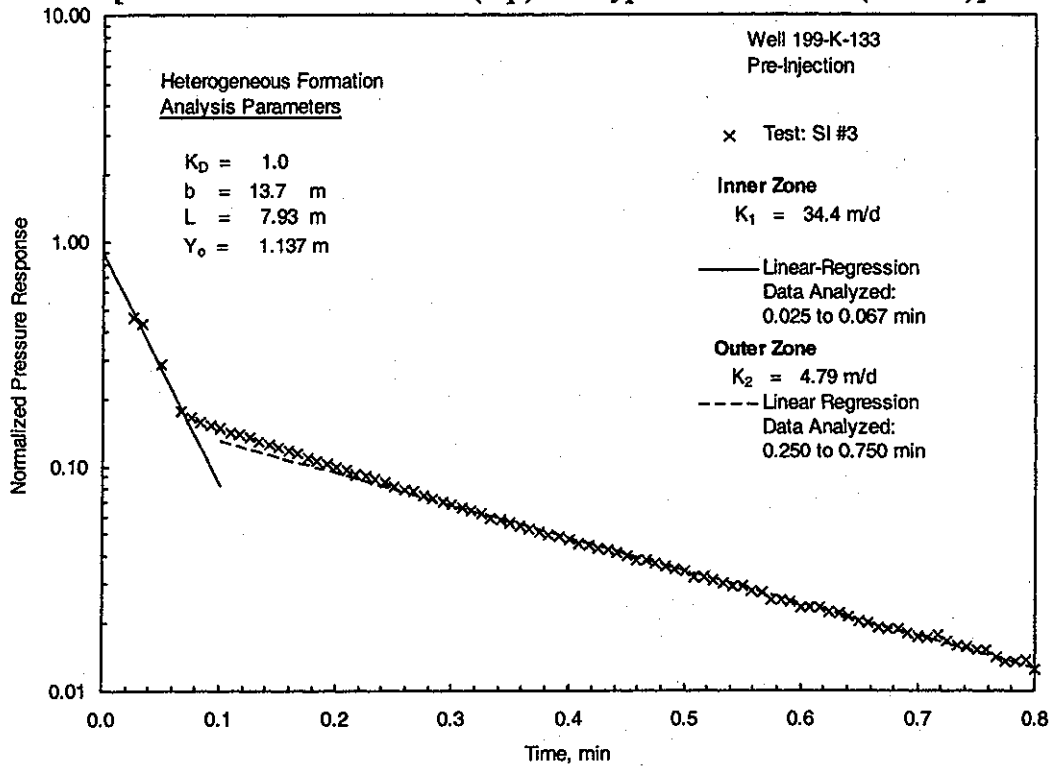

Figure A.2. Selected Pre-Injection Slug-Test Analysis Plots for Injection Well K-134 [Bouwer and Rice method (top) and type-curve method (bottom)]

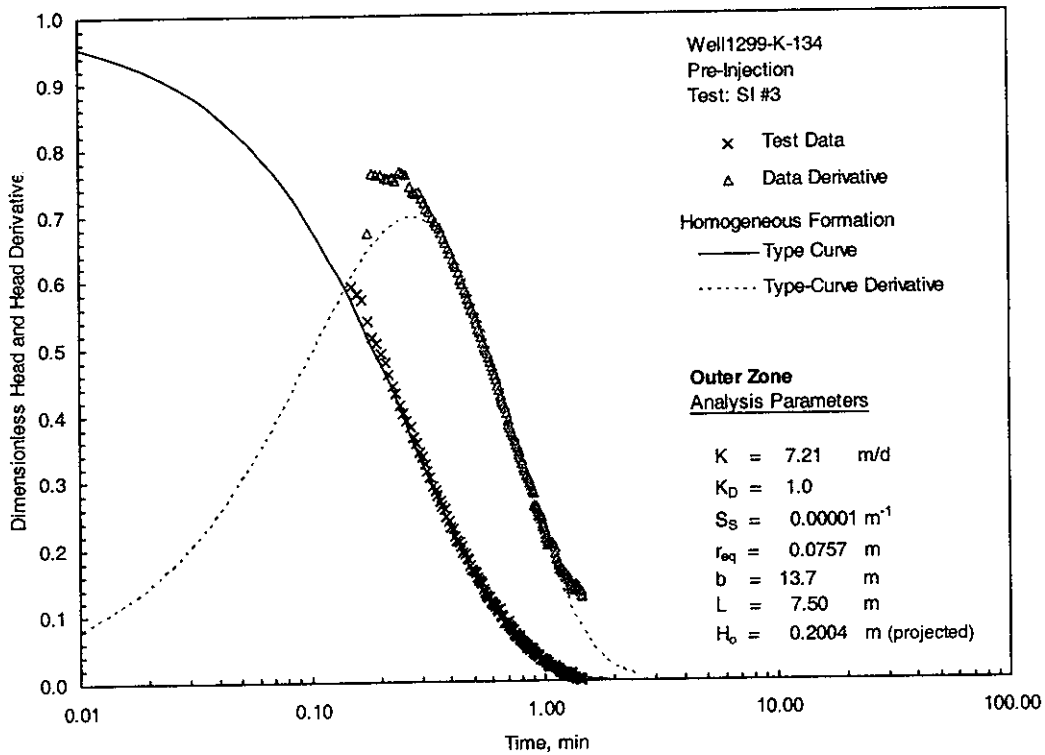
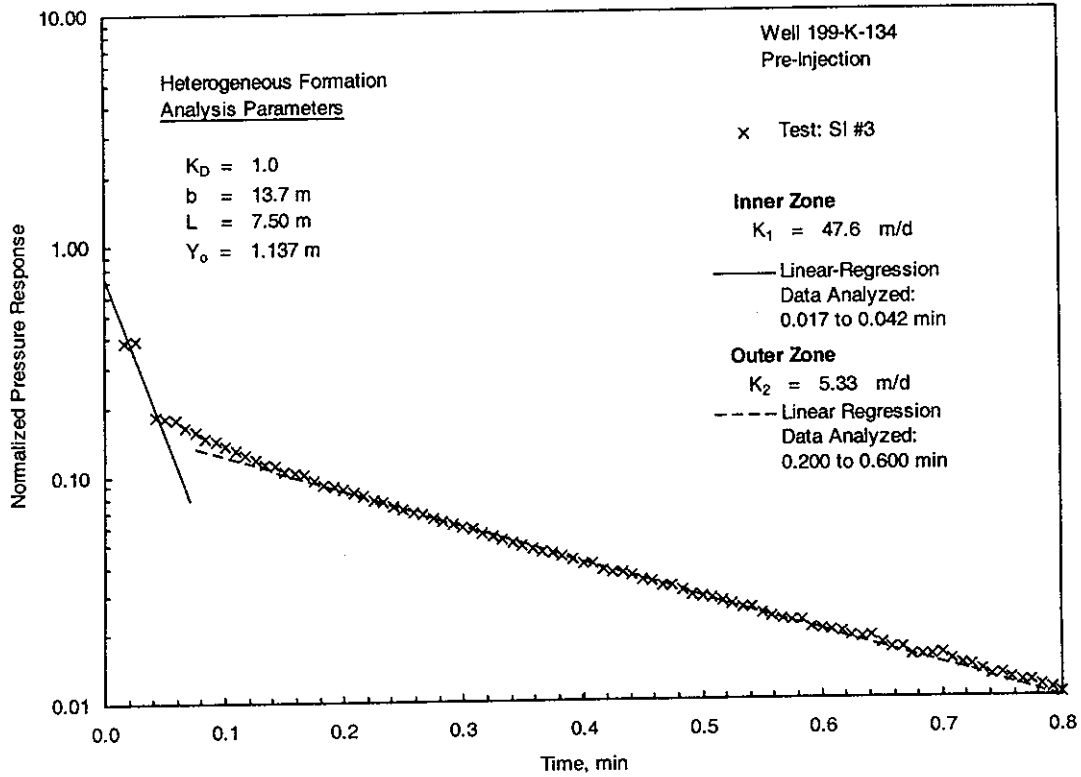

Figure A.3. Selected Pre-Injection Slug-Test Analysis Plots for Injection Well K-135 [Bouwer and Rice method (top) and type-curve method (bottom)]

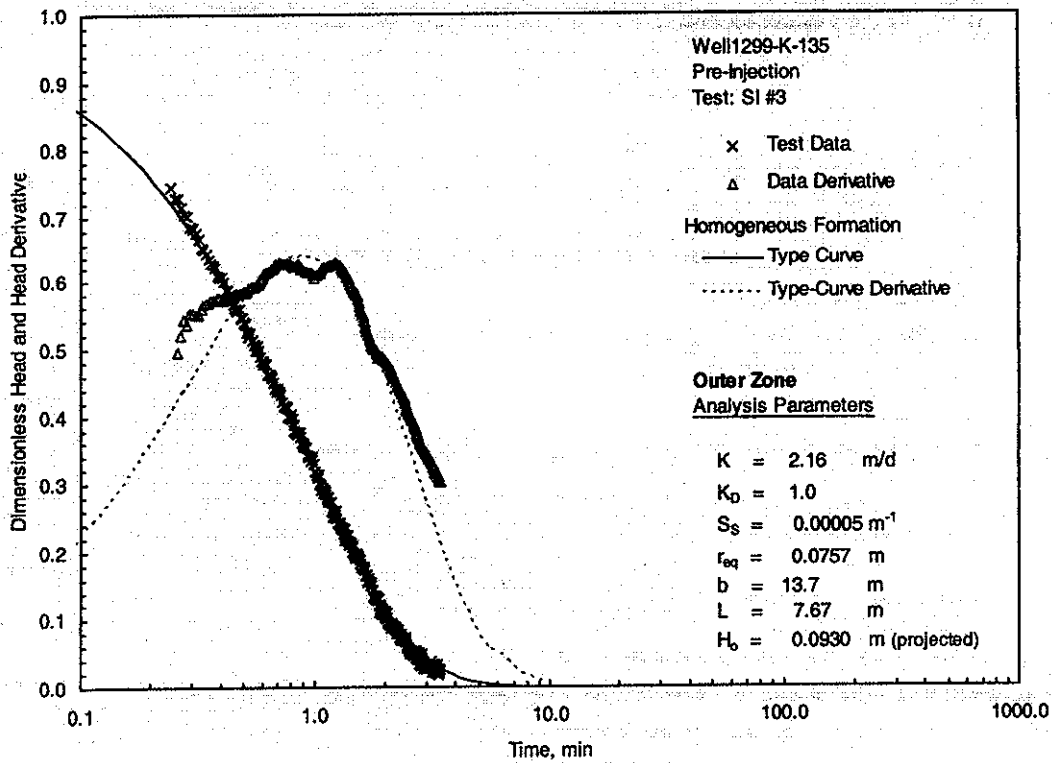
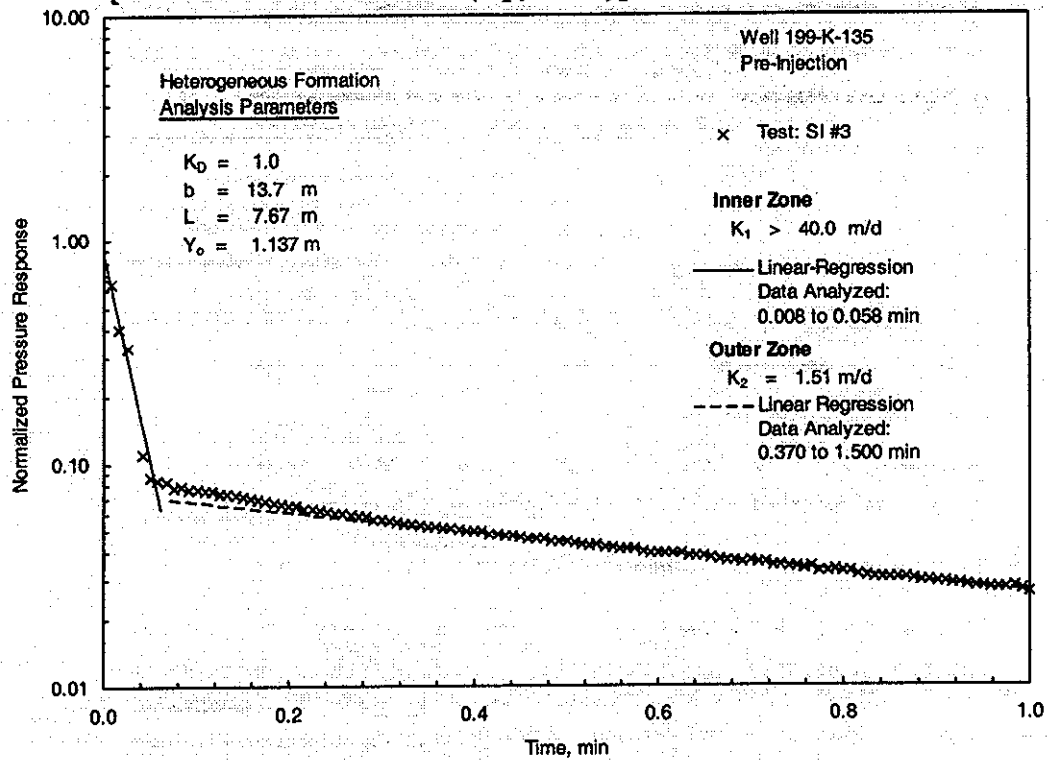

Figure A.4. Selected Pre-Injection Slug-Test Analysis Plots for Injection Well K-136 [Bouwer and Rice method (top) and type-curve method (bottom)]

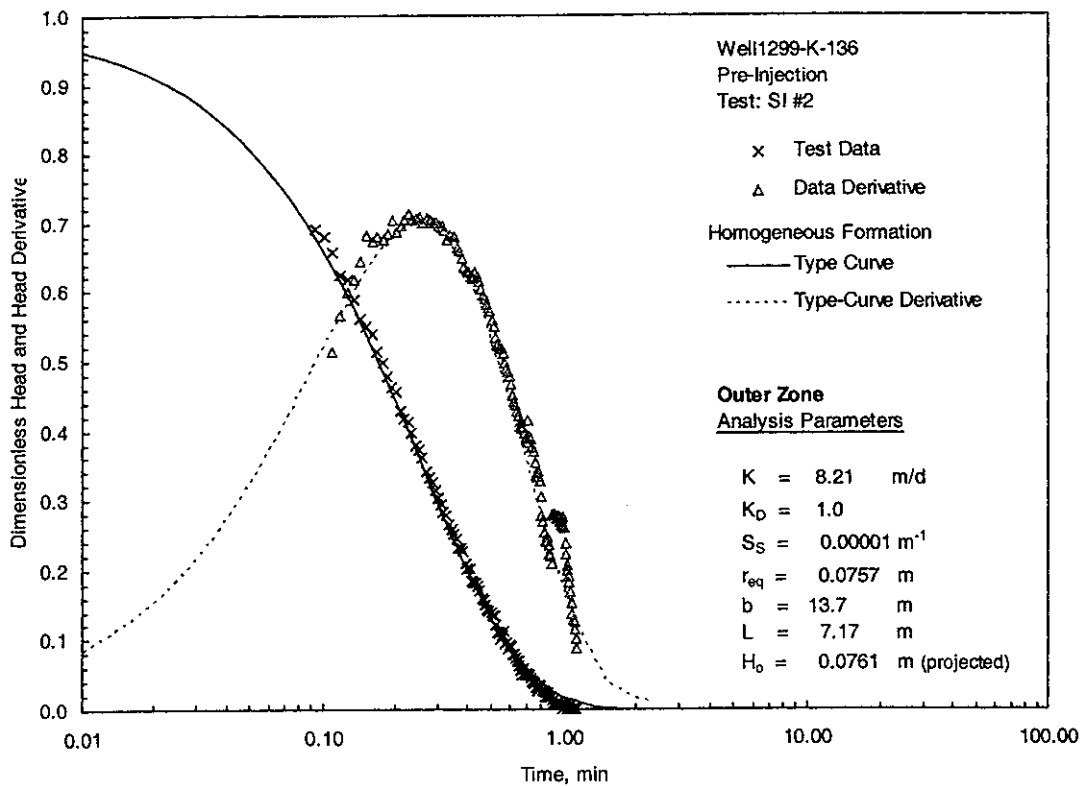
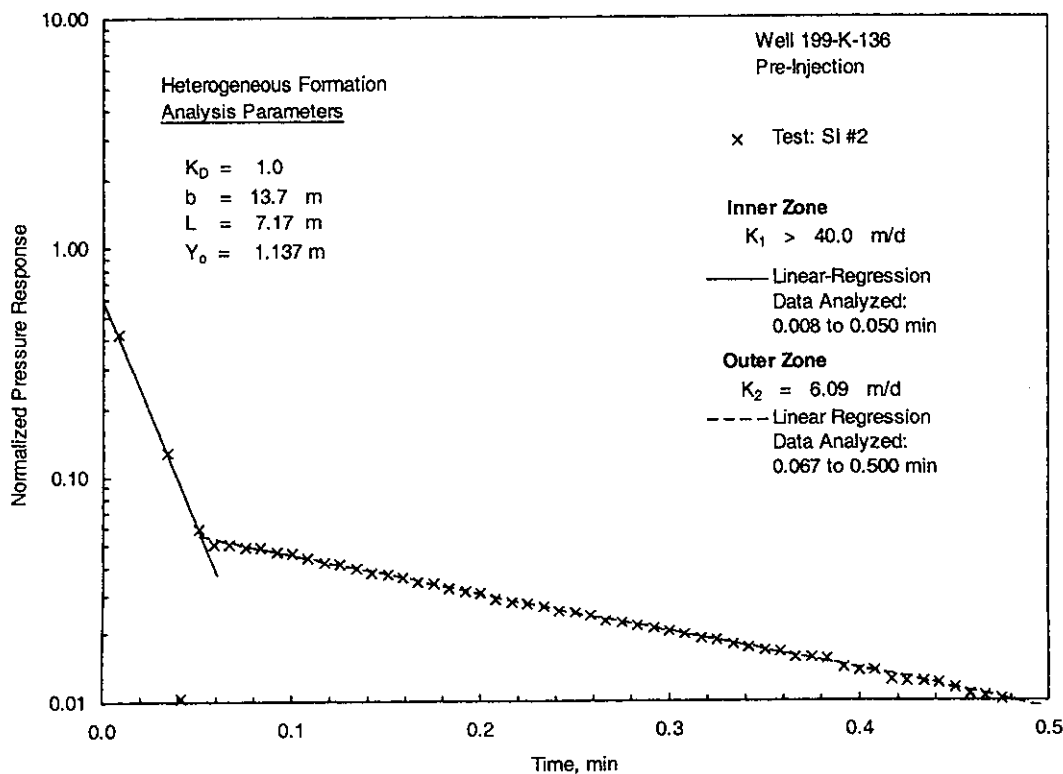

Figure A.5. Selected Pre-Injection Slug-Test Analysis Plots for Extraction Well K-126 [Bouwer and Rice method (top) and type-curve method (bottom)]

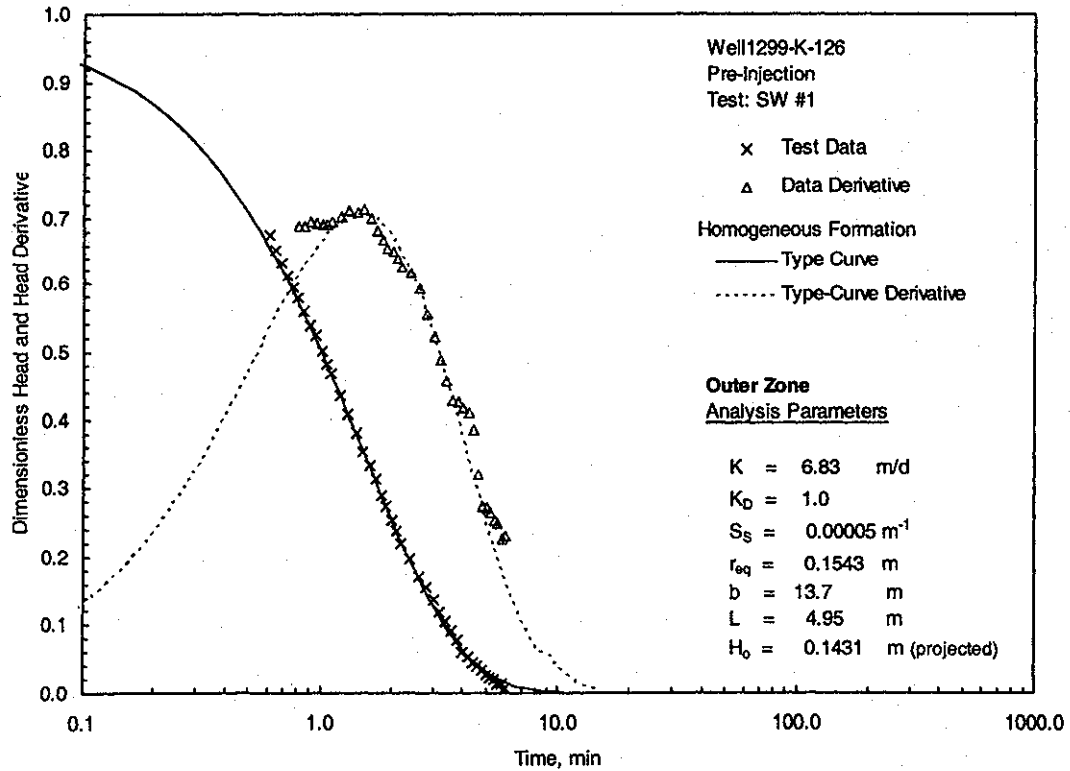
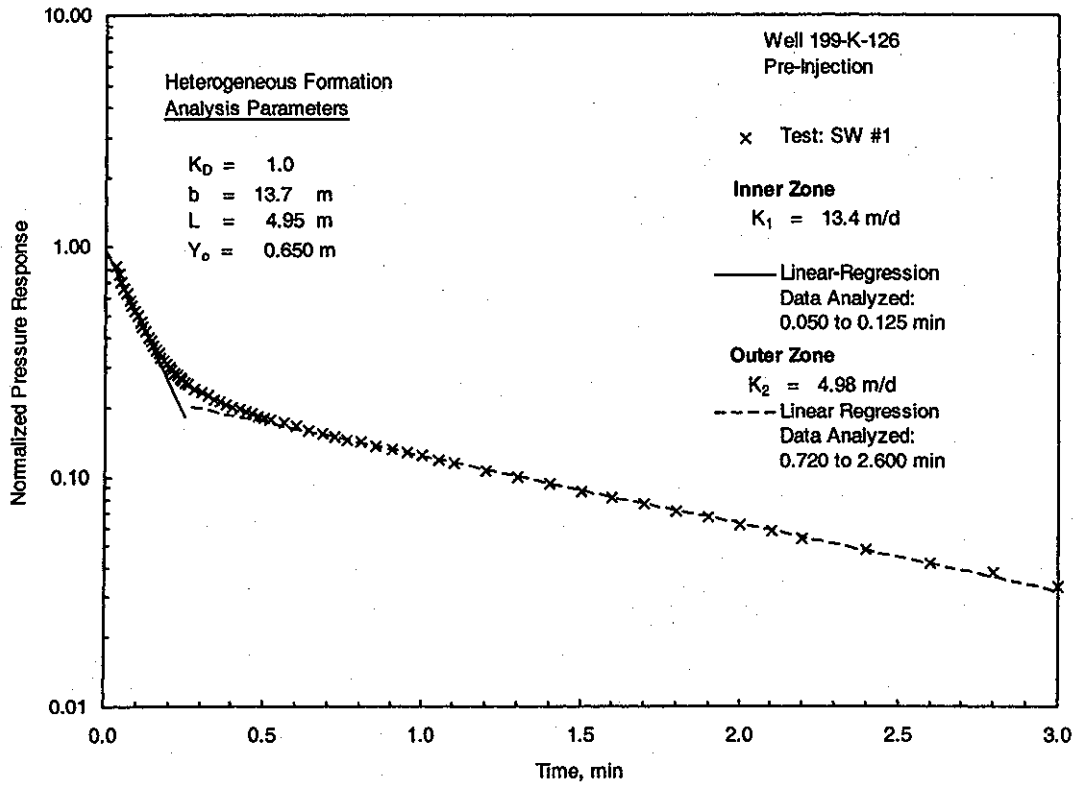
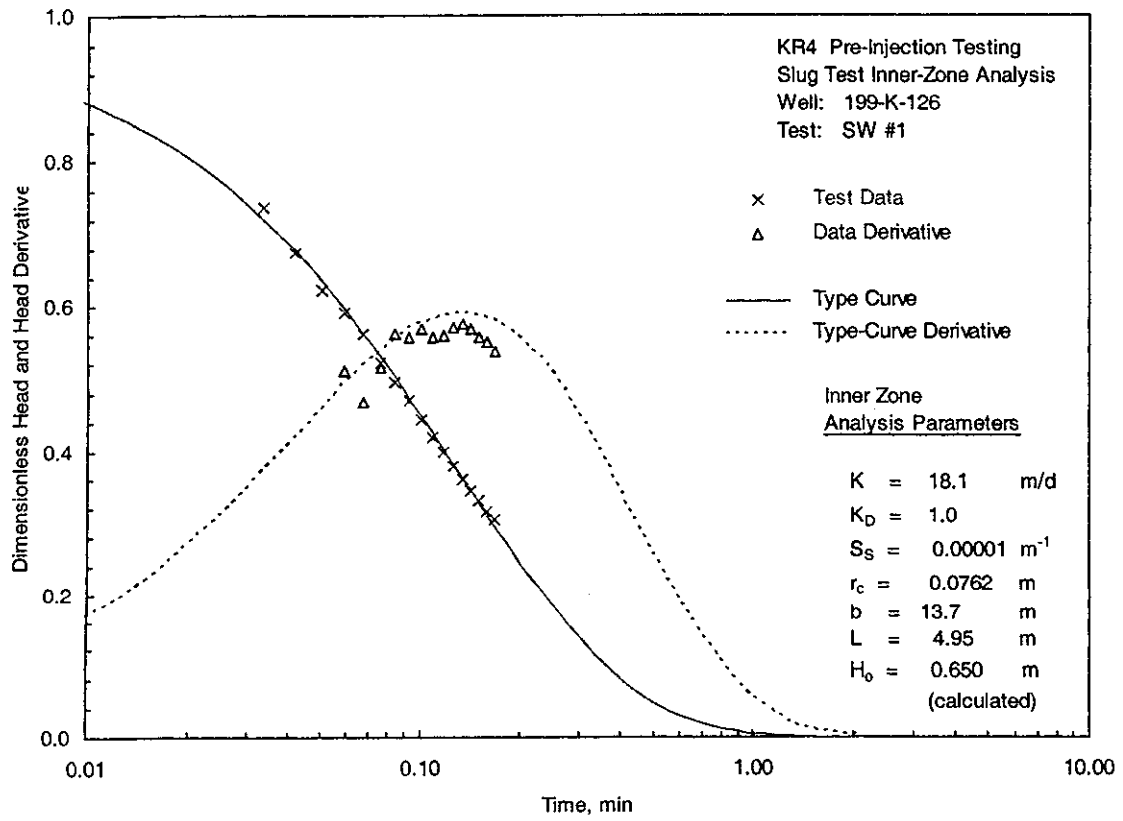

Figure A.6. Selected Pre-Injection Slug-Test Analysis Plots for Extraction Well K-126; Type-Curve Inner Zone Analysis



Appendix B:

Pre-Test Tracer Prediction Plots

- B.1 Predictive Comparison of Analytical and Numerical Model Results**
- B.2 Effects of Dispersivity on Predicted Tracer Breakthrough Patterns at KR-4 Extraction Well 199-K-126: $D_1 = 2.5, 5, \text{ and } 10 \text{ m}$**
- B.3 Effects of Effective Porosity on Predicted Tracer Breakthrough Patterns at KR-4 Extraction Well 199-K-126: $n_e = 0.05, 0.1, \text{ and } 0.2$**
- B.4 Predicted Areal Reactant Isochron Map, After 1-Week of Continuous Tracer Injection ($D_1 = 5.0 \text{ m}; n_e = 0.1; \text{ Contour Interval} = 10 \text{ mg/L}$)**
- B.5 Predicted Areal Reactant Isochron Map, After 3-Months of Continuous Tracer Injection ($D_1 = 5.0 \text{ m}; n_e = 0.1; \text{ Contour Interval} = 10 \text{ mg/L}$)**

Figure B.1 Predictive Comparison of Analytical and Numerical Model Results

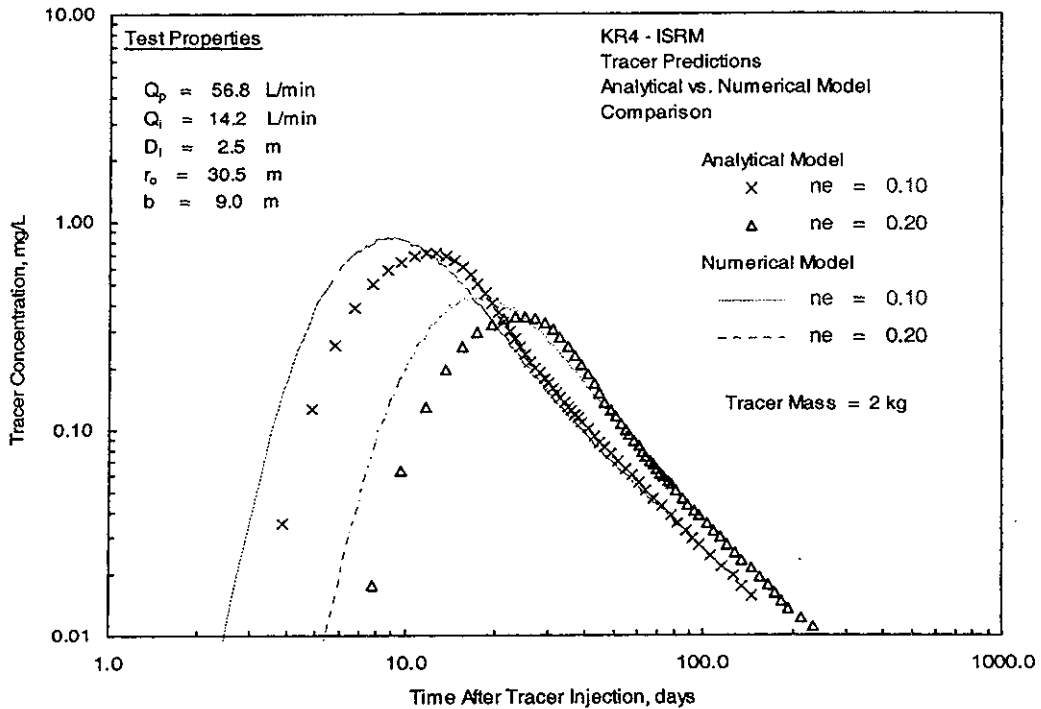

Figure B.2 Effects of Dispersivity on Predicted Tracer Breakthrough Patterns at KR-4 Extraction Well 199-K-126: $D_1 = 2.5, 5,$ and 10 m

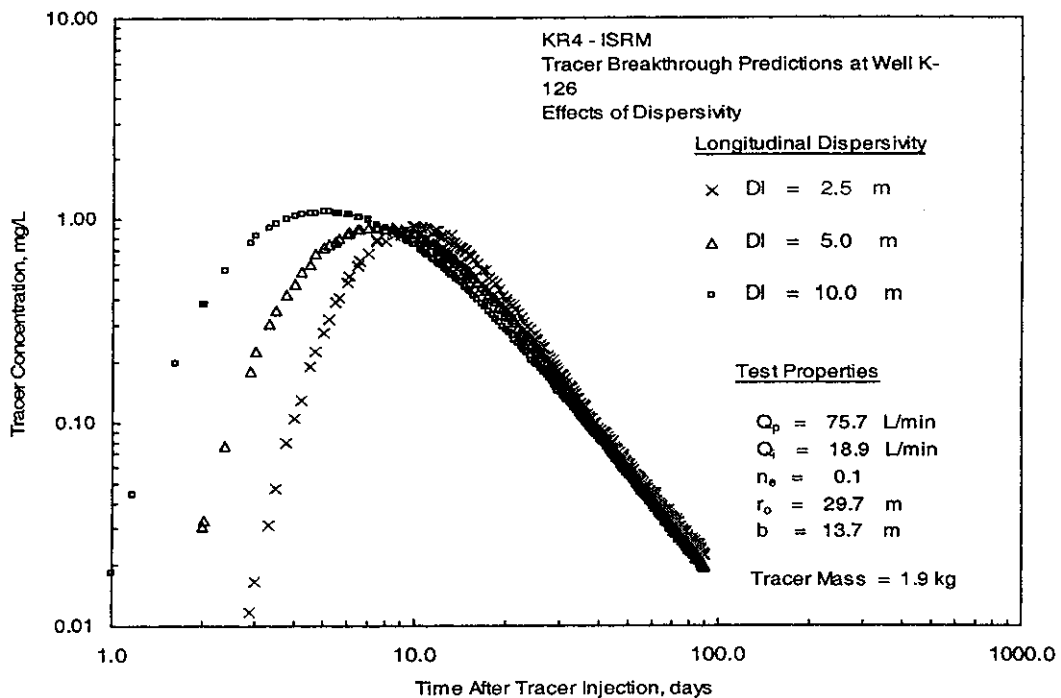

Figure B.3 Effects of Effective Porosity on Predicted Tracer Breakthrough Patterns at KR-4 Extraction Well 199-K-126: $n_e = 0.05, 0.1, \text{ and } 0.2$

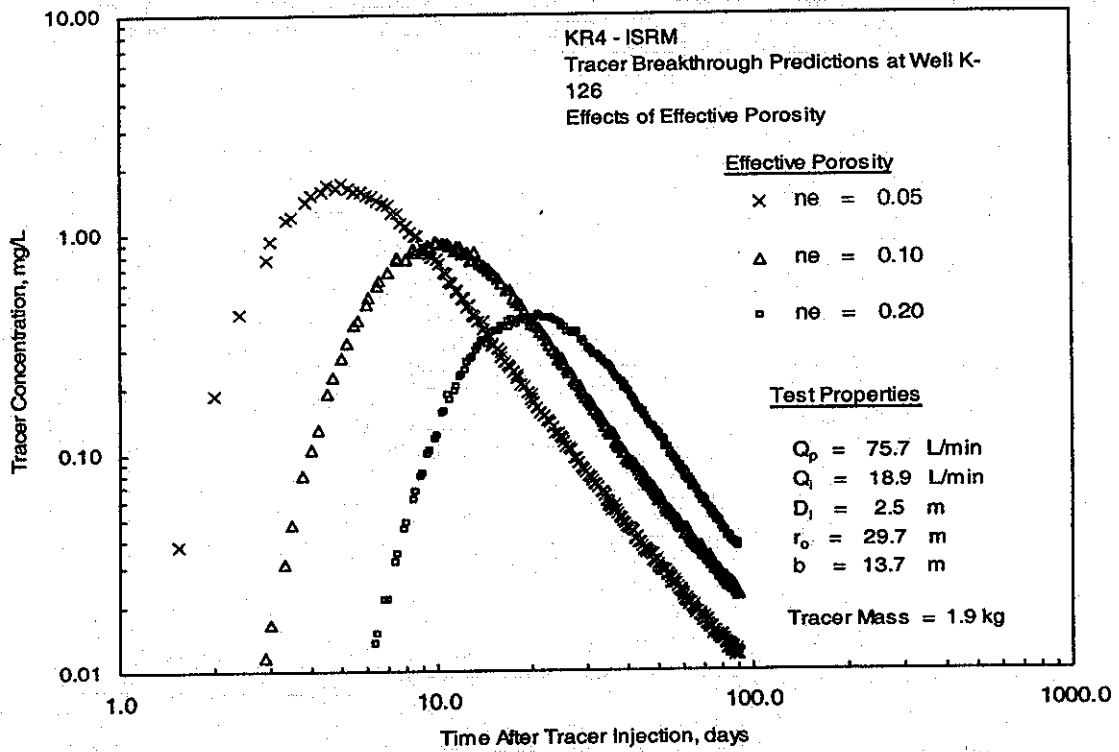

Figure B.4 Predicted Areal Reactant Isochron Map, After 1-Week of Continuous Tracer Injection ($D_1 = 5.0 \text{ m}$; $n_e = 0.1$; Contour Interval = 10 mg/L)

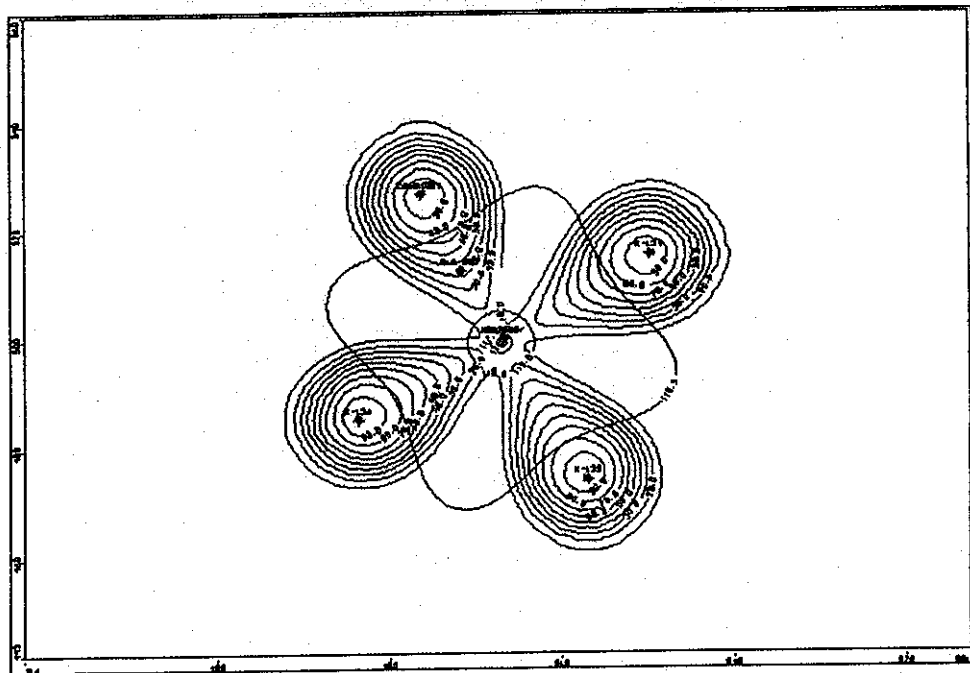
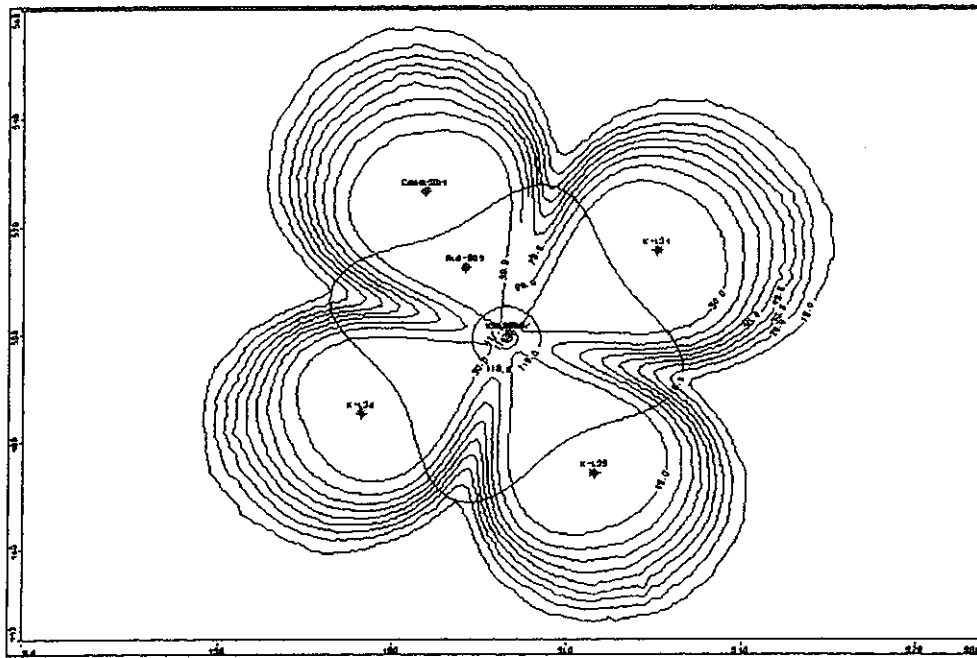

Figure B.5 Predicted Areal Reactant Isochron Map, After 3-Months of Continuous Tracer Injection ($D_1 = 5.0$ m; $n_e = 0.1$; Contour Interval = 10 mg/L)



Appendix C:

Miscellaneous Field Testing Pictures

- C.1 Adhering Reactant Solution on Weighted Steel-Tape, Retrieved from Injection Well K-135**
- C.2 Adhering Reactant Solution on Injection Line Retrieved from a KR-4 Injection Well**

Figure C.1. Adhering Reactant Solution on Weighted Steel-Tape, Retrieved from Injection Well K-135



Figure C.2. Adhering Reactant Solution on Injection Line Retrieved from a KR-4 Injection Well

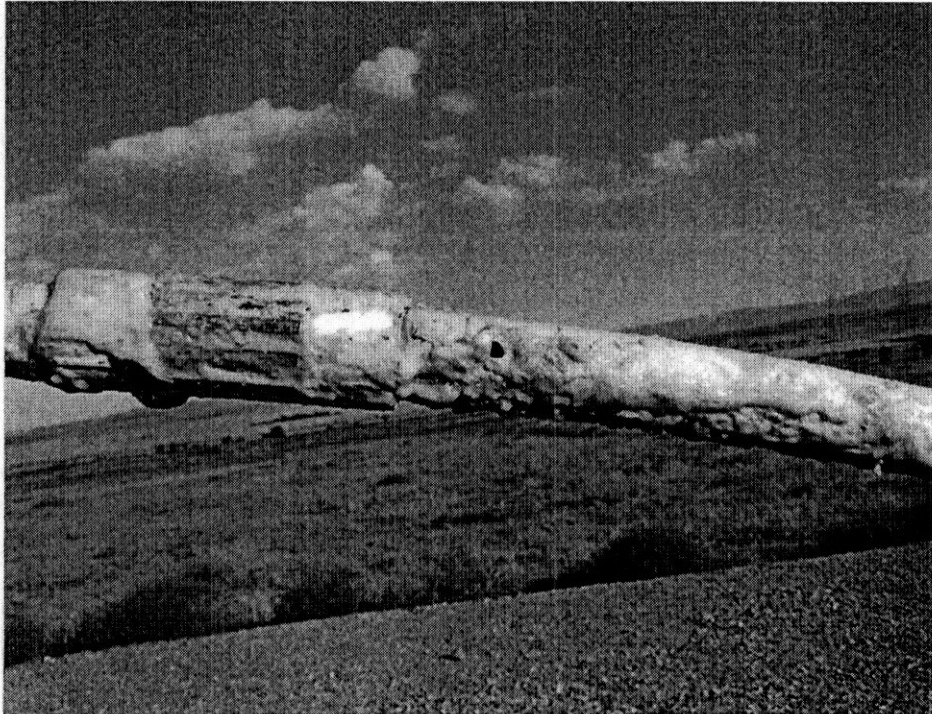

Appendix D:

Selected KR-4 Post-Injection Slug Test Analysis Figures

- D.1 Selected Post-Injection Slug-Test Analysis Plots for Injection Well K-133 [Bouwer and Rice method (top) and type-curve method (bottom)]**
- D.2 Selected Post-Injection Slug-Test Analysis Plots for Injection Well K-134 [Bouwer and Rice method (top) and type-curve method (bottom)]**
- D.3 Selected Post-Injection Slug-Test Analysis Plots for Injection Well K-135 [Bouwer and Rice method (top) and type-curve method (bottom)]**
- D.4 Selected Post-Injection Slug-Test Analysis Plots for Injection Well K-136 [Bouwer and Rice method (top) and type-curve method (bottom)]**
- D.5 Selected Post-Injection Slug-Test Analysis Plots for Extraction Well K-126 [Bouwer and Rice method (top) and type-curve method (bottom)]**
- D.6 Selected Post-Injection Slug-Test Analysis Plots for Extraction Well K-126: Type-Curve Inner Zone Analysis**

Figure D.1. Selected Post-Injection Slug-Test Analysis Plots for Injection Well K-133 [Bouwer and Rice method (top) and type-curve method (bottom)]

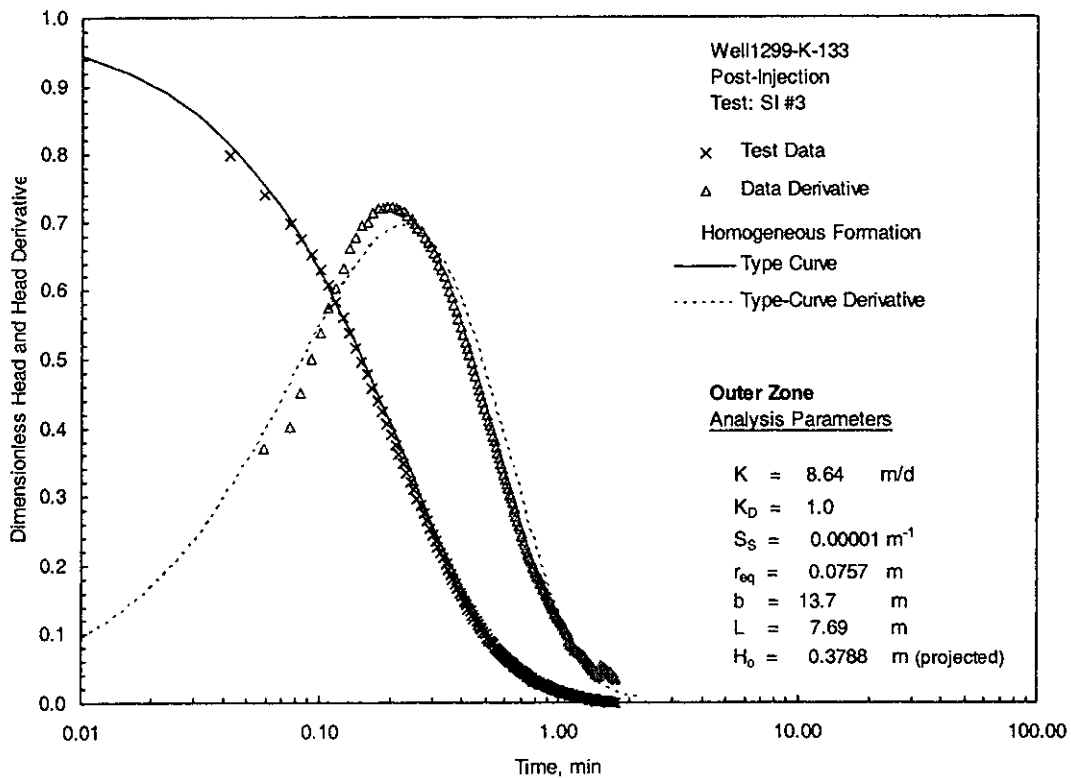
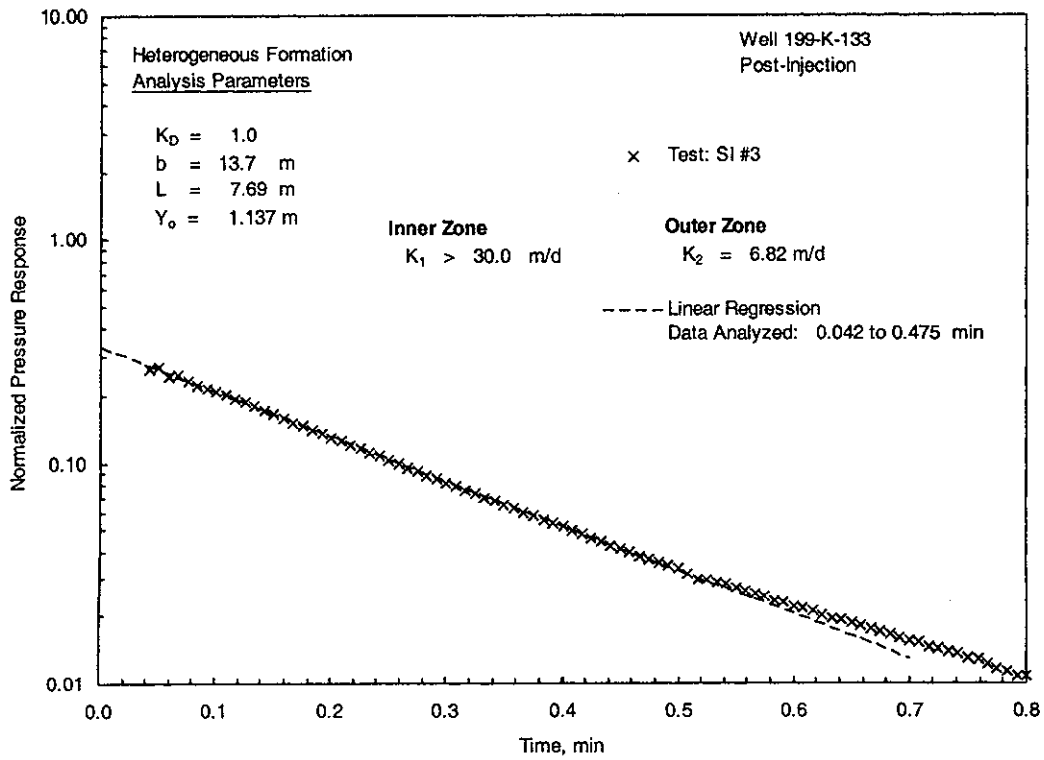

Figure D.2. Selected Post-Injection Slug-Test Analysis Plots for Injection Well K-134 [Bouwer and Rice method (top) and type-curve method (bottom)]

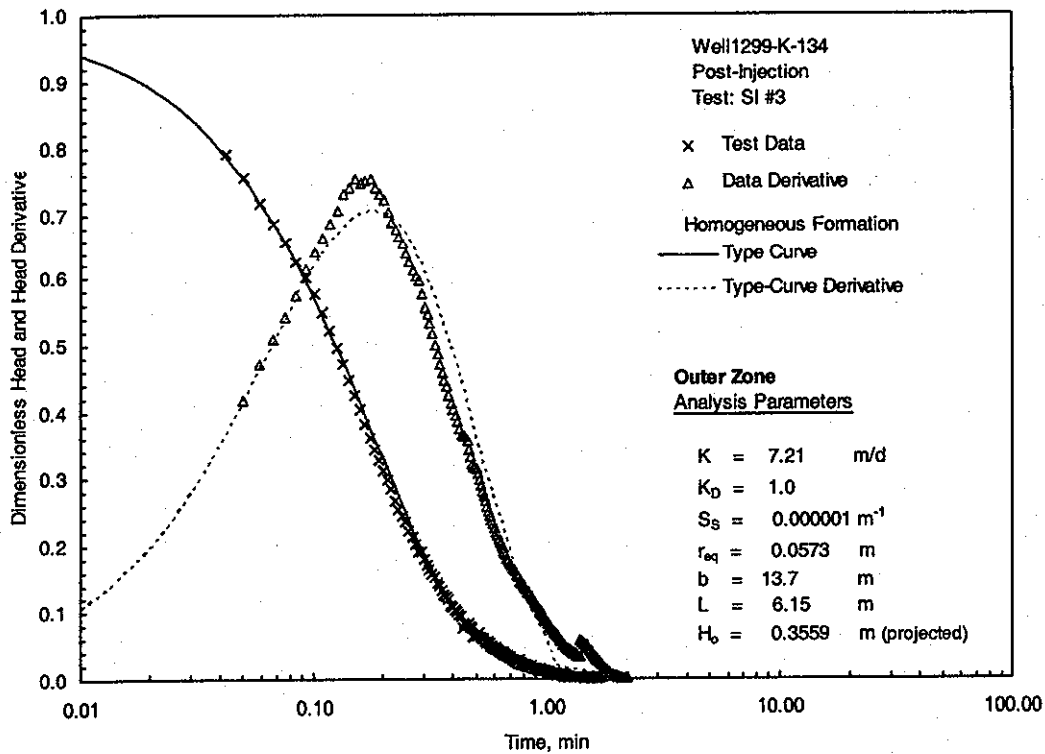
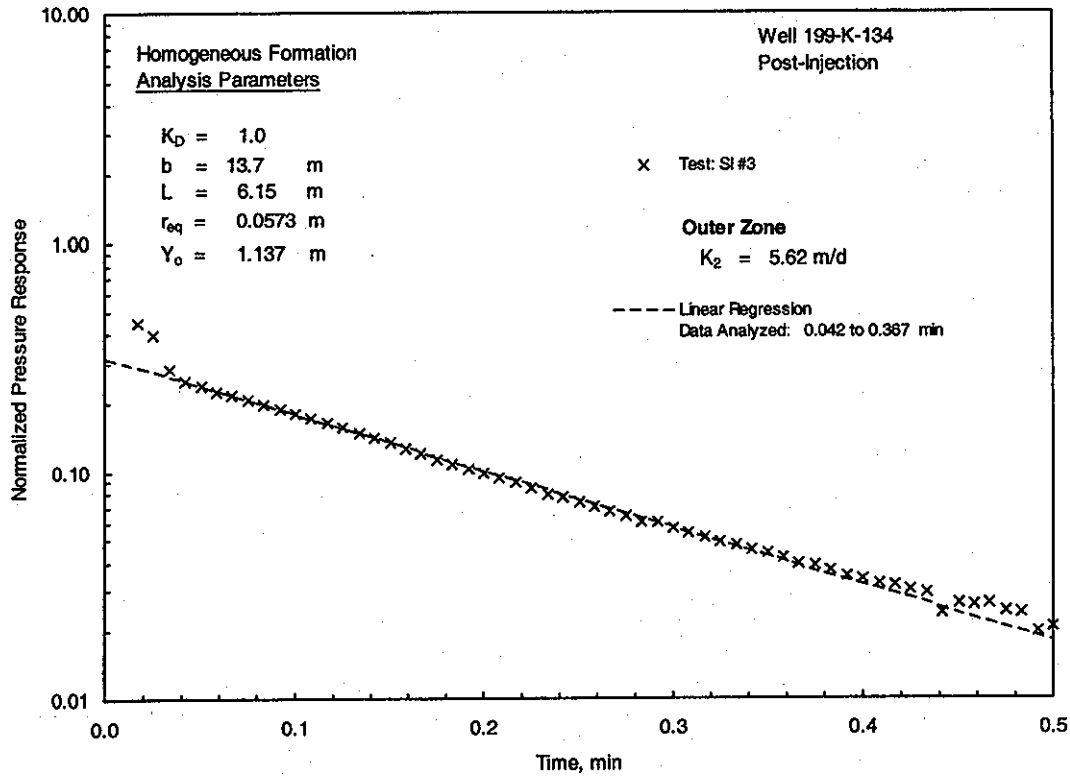

Figure D.3. Selected Post-Injection Slug-Test Analysis Plots for Injection Well K-135 [Bouwer and Rice method (top) and type-curve method (bottom)]

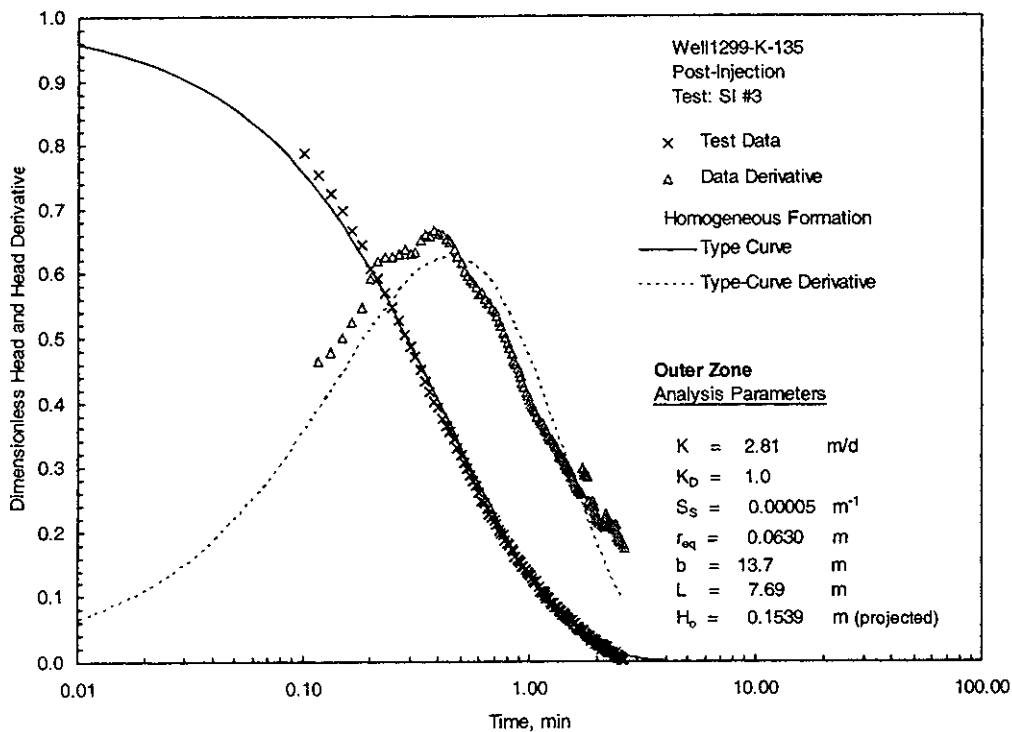
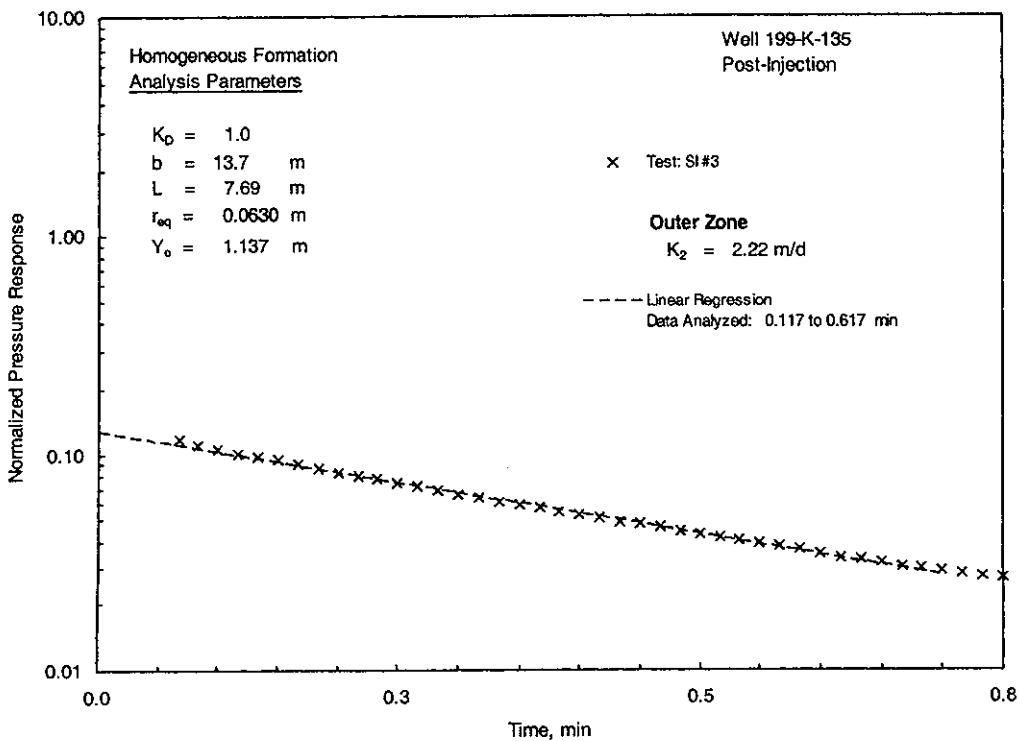

Figure D.4. Selected Post-Injection Slug-Test Analysis Plots for Injection Well K-136 [Bouwer and Rice method (top) and type-curve method (bottom)]

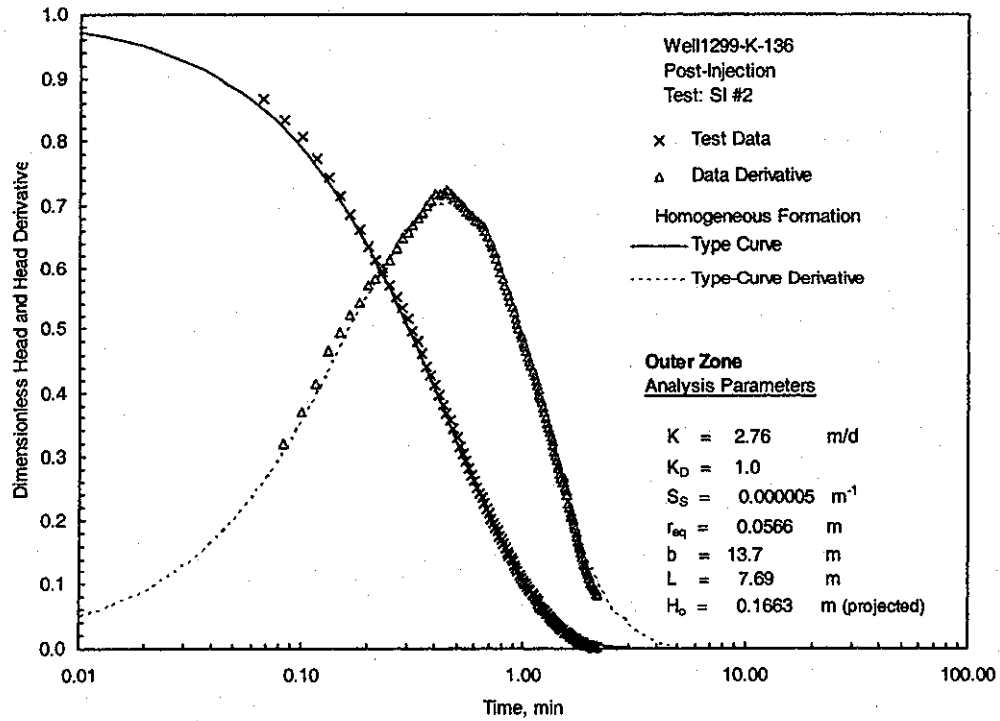
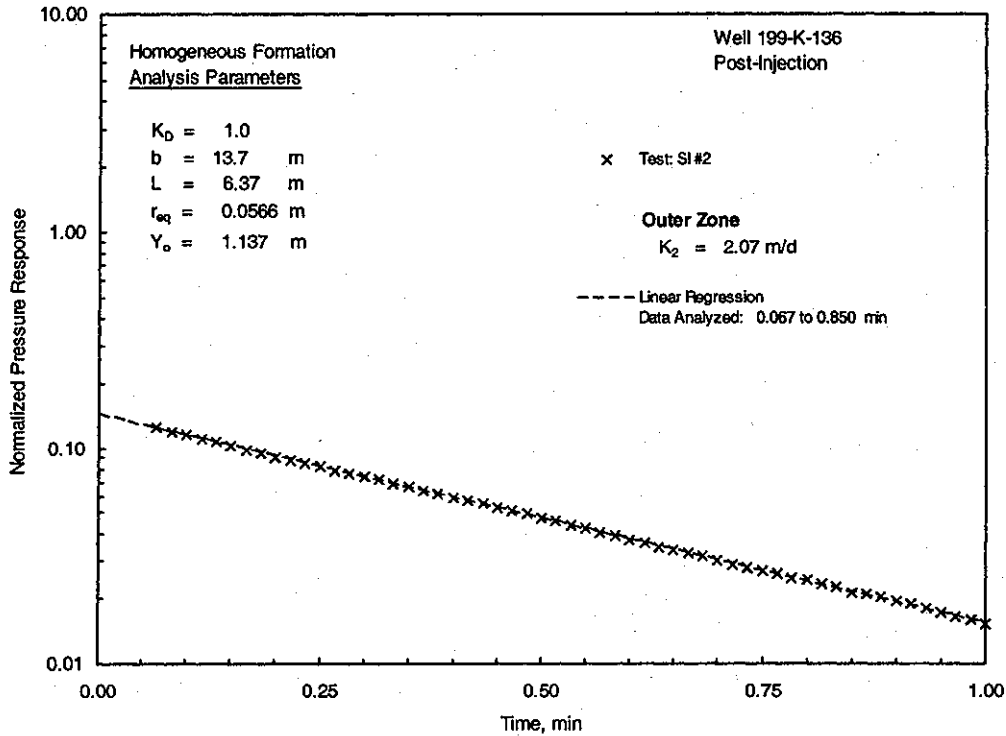

Figure D.5. Selected Post-Injection Slug-Test Analysis Plots for Extraction Well K-126 [Bouwer and Rice method (top) and type-curve method (bottom)]

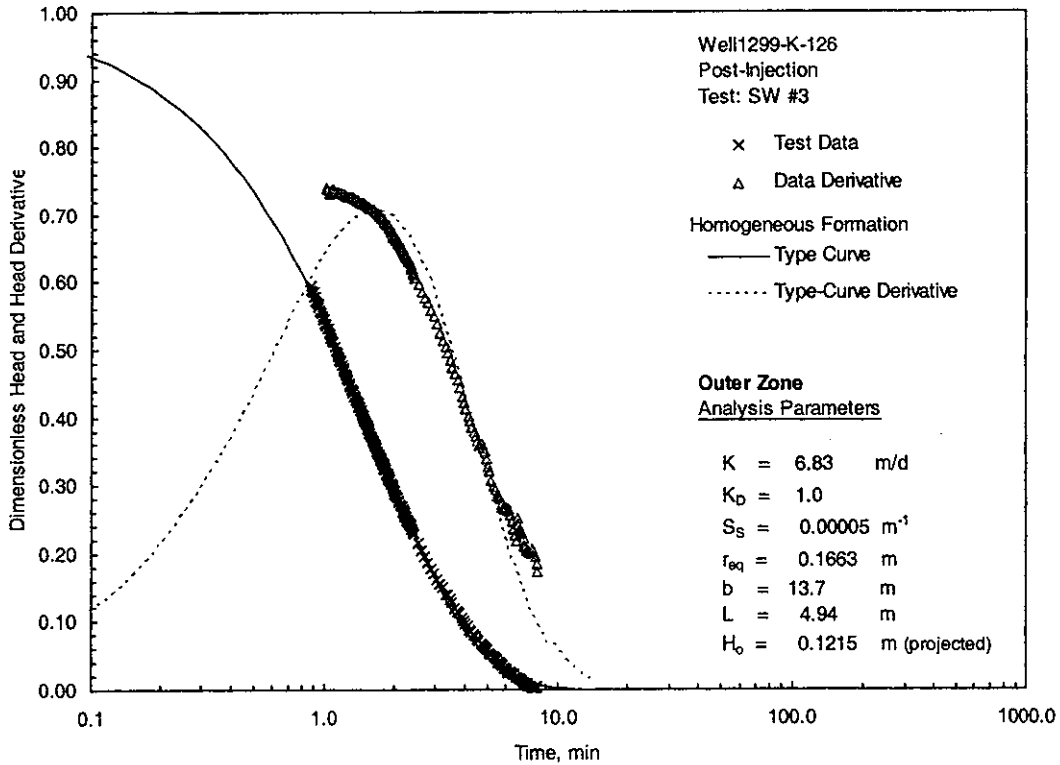
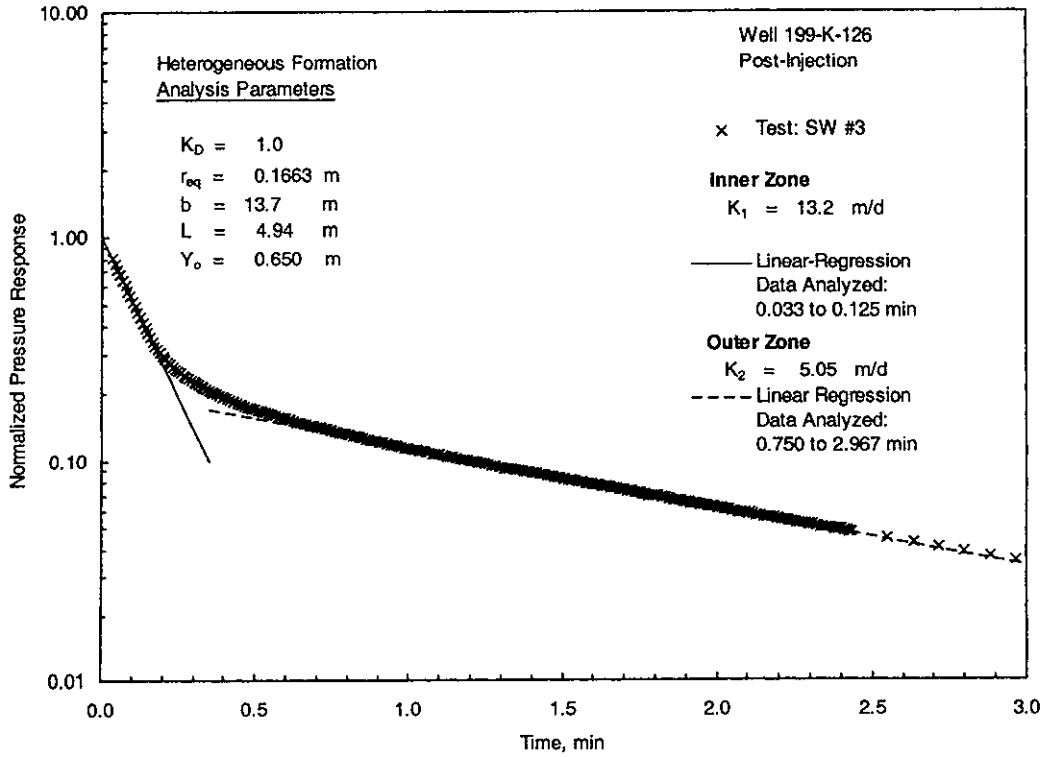
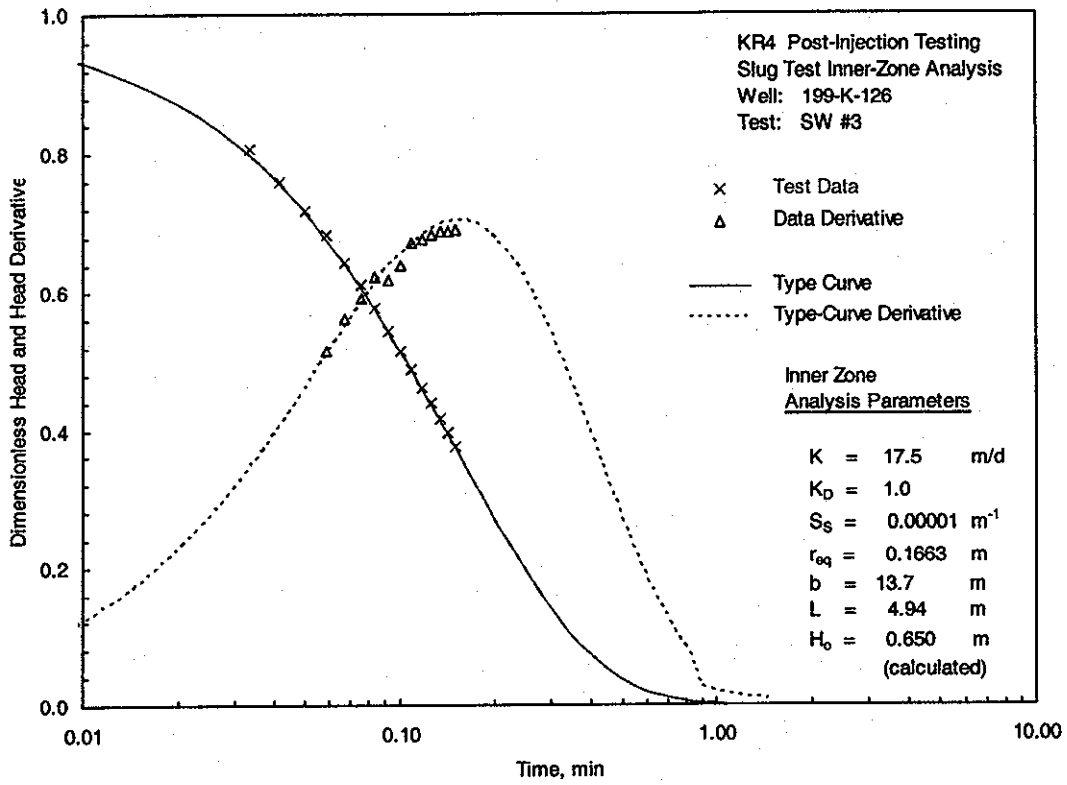

Figure D.6. Selected Post-Injection Slug-Test Analysis Plots for Extraction Well K-126:
Type-Curve Inner Zone Analysis



This page intentionally left blank.

APPENDIX B
ANALYTICAL RESULTS

This page intentionally left blank.

Table 1 Groundwater Analyses from the Treatability Test Extraction Well, 199-K-126 (Page 1 of 3).

HEIS No.	6/27/2005	6/30/2005	7/5/2005	7/6/2005	7/8/2005	7/12/2005	7/14/2005	7/18/2005	7/20/2005	7/22/2005	7/25/2005
Analyte	B1DDM0	B1DDR4	B1DFO0	B1DF32	B1DF33	B1DFH0	B1DFK3	B1DFK5	B1DFK8	B1DFL0	B1DJY4
units						REBOUND		REBOUND			REBOUND
Cr+6	70	65	22	34	18	23	0	5	9	0	9
NO2-	0.006	0.006	0.028	0.058	0.071	0.039	0.084	0.868	0.163	0.29	0.64
NO3-	4.4	1.6	0	0	1.1	0	0	1.3	0	0	0.5
SO42-	-	-	-	-	-	-	63	70	63	63	78
pH	7.378	7.920	8.194	8.270	8.016	8.085	8.493	7.278	7.861	9.008	8.402
Temp	19.7	22.4	22.7	22.5	21.5	22.4	21.7	23.2	23.4	22	21
Cond	289	349	471	450	446	478	538	422	519	575	482
DO	7.7	7.3	6.4	6.7	5.2	6.3	3.4	1.8	5.4	2.3	3.3
ORP	250.3	169.9	-96.4	-105.2	73.3	-130.3	-190.5	-60.2	-194.3	-309.5	-245.8
Lionville	B1DDM1	B1DDR3	B1DFO1			B1DFH1			B1DFK6		
Hardness	134	140	196	-	-	192	-	-	223	-	-
TINC	22.8	22.3	23.2	-	-	22.4	-	-	22.3	-	-
WSCF											
Cr+6	71	55	54	-	-	0	-	-	0	-	-
Alkalinity	95	95	85	-	-	85	-	-	85	-	-
TOC	0.3	2.09	0.3	-	-	0.3	-	-	0.3	-	-
Cl-	8.36	9.26	9.65	-	-	8.63	-	-	8.96	-	-
NO2-	0.006	0.006	0.006	-	-	0.0629	-	-	0.172	-	-
Br-	0.09	0.211	0.163	-	-	0.171	-	-	0.221	-	-
NO3-	2.38	2.75	2.78	-	-	2.27	-	-	2.4	-	-
SO42-	39.1	44	45.4	-	-	44.5	-	-	50.5	-	-
Fe	0.021	0.021	0.03	-	-	0.021	-	-	0.021	-	-
Mg	9.91	10.2	14	-	-	14	-	-	13.5	-	-
Mn	0.0003	0.0003	0.0208	-	-	0.0202	-	-	0.056	-	-
K	4.78	4.78	5.39	-	-	5.29	-	-	5.32	-	-
Na	11.1	10.8	12	-	-	11.9	-	-	11.5	-	-
Ca	40	42.7	62.1	-	-	61	-	-	66.4	-	-
Cr	0.062	0.062	0.056	-	-	0.061	-	-	0.0566	-	-
Pb	0.0002	0.0002	0.0002	-	-	0.0002	-	-	0.0002	-	-
As	0.00381	0.00357	0.00364	-	-	0.00413	-	-	0.00538	-	-

bold=non-detect

Table 2 Groundwater Analyses from the Treatability Test Extraction Well, 199-K-126

(Page 2 of 3).

HEIS No.	Analyte	7/27/2005	7/28/2005	8/2/2005	8/2/2005	8/3/2005	8/5/2005	8/8/2005	8/9/2005	8/10/2005	8/10/2005	8/10/2005
		B1DJY5	B1DJY6	B1DJY7	B1DJY8	B1DJY9	B1DLH4	B1DLH5	B1DLH6	B1DMD9	B1DMF0	B1DMF1
	units			REBOUND	100 gals	500 gals			REBOUND	>50 gals	100 gals	500 gals
	Cr+6	0	0	0-50 gals	5	0	0	0	0	69	27	27
	NO2-	0.288	0.174	1	0.231	0.286	0.33	0.26	0.249	0.72	0.265	0.274
	NO3-	0	0	1	0	0	0	0	0	0	0	0
	SO42-	67	74	110	46	67	80	66	66	56	84	68
	Fe _{tot}	-	-	-	-	-	-	-	-	0.59	0.34	0.54
	pH	8.649	8.931	7.392	8.729	8.762	8.982	9.145	8.902	8.691	8.755	8.934
	Temp	22.3	23.9	20.8	20.1	20.6	21	21.2	21.8	21	21	21.9
	Cond	636	654	491	487	533	583	586	528	554	562	566
	DO	1.3	0.7	3.9	3.6	3.5	2.2	0.4	2	1	2.9	1.8
	ORP	-344.1	-380.6	-249.5	-278.2	-288.8	-336.3	-401.9	-289.2	-329.8	-304.9	-310.6
	Lionville		B1DH90				B1DLH7					B1DMF2
	Hardness	-	271	-	-	-	275	-	-	-	-	271
	TINC	-	16.8	-	-	-	13.3	-	-	-	-	21.4
	WSCF	-	ND	-	-	-	40 EX	-	-	-	-	0
	Cr+6	-	89	-	-	-	80	-	-	-	-	94
	Alkalinity	-	0.3	-	-	-	ND	-	-	-	-	0.3
	TOC	-	10.1	-	-	-	7.52	-	-	-	-	9.59
	Cl-	-	0.447	-	-	-	0.433	-	-	-	-	0.443
	NO2-	-	0.212	-	-	-	0.184	-	-	-	-	0.239
	Br-	-	2.2	-	-	-	1.28	-	-	-	-	2.4
	NO3-	-	59.9	-	-	-	56	-	-	-	-	62
	SO42-	-	0.021	-	-	-	0.0409	-	-	-	-	0.021
	Fe	-	14.8	-	-	-	14.9	-	-	-	-	14.6
	Mg	-	5.59	-	-	-	5.51	-	-	-	-	5.65
	Mn	-	12.1	-	-	-	12.4	-	-	-	-	12.5
	K	-	93	-	-	-	93.4	-	-	-	-	88.6
	Na	-	0.0421	-	-	-	0.0216	-	-	-	-	0.0334
	Ca	-	0.000309	-	-	-	0.0002	-	-	-	-	0.0002
	Cr	-	0.00583	-	-	-	0.00875	-	-	-	-	0.00845
	Pb	-	-	-	-	-	-	-	-	-	-	-
	As	-	-	-	-	-	-	-	-	-	-	-

bold=non-detect

Table 3 Groundwater Analyses from the Treatability Test Extraction Well, 199-K-126 (Page 3 of 3).

HEIS No.	Analyte	units	8/17/2005	8/17/2005	8/17/2005	8/25/2005	9/20/2005	9/20/2005	9/20/2005	9/20/2005	11/21/2005	12/6/2005	1/5/2006	2/8/2006
			B1DNP9 REBOUND 0-50 gals	1DNRO 100 gals	1DNR1 500 gals	B1DVL0 NA	NA 0-50 gals	NA 100 gals	B1DVL1 500 gals	B1DVL2 bailed	B1H4K3 bailed	B1HB54	B1HLK2	
	Cr+6	ug/l	0	0	0	22	0	0	10	0	0	0	0	
	NO2-	mg/l	0.352	0.271	0.296	0.175	0.005	0.078	0.138	-	-	-	-	
	NO3-	mg/l	1	0	0	0.7	6.7	5.5	5.8	-	-	-	-	
	SO42-	mg/l	72	82	74	-	116	96	88	-	-	129	-	
	Fe _{tot}	mg/l	0.02	0	0.01	-	-	-	-	-	-	-	-	
	pH		8.433	8.596	8.784	8.112	7.468	7.875	8.135	7.282	7.057	7.193	7.019	
	Temp		19.5	19.7	19.6	20	19.3	19.9	19.7	18	16.4	17.4	18.6	
	Cond		550	553	555	502	442	448	478	483	541	465	485	
	DO	mg/l	3.8	4.6	4.1	4.8	2.7	3.8	4.9	3	2.2	27.2	36.8	
	ORP	mg/l	-89.9	-259	-274	-232	-214.2	-204.3	-223.4	-129.5	-216.9	-39	-69.4	
	Lionville					B1DVL3			B1DVL4	B1DVL5			B1HLK7	
	Hardness	mg/l	-	-	-	-	-	-	-	-	-	-	-	
	TINC	mg/l	-	-	-	-	-	-	-	-	-	-	-	
	WSCF	ug/l	-	-	-	27.4	-	-	50.6	6.8	-	-	-	
	Cr+6	mg/l	-	-	-	-	-	-	-	91	-	-	-	
	Alkalinity	mg/l	-	-	-	0.3	-	-	0.3	0.3	-	-	-	
	TOC	mg/l	-	-	-	9.13	-	-	9.26	7.39	-	-	-	
	Cl-	mg/l	-	-	-	0.264	-	-	2.86	0.0196	-	-	-	
	NO2-	mg/l	-	-	-	0.224	-	-	0.385	0.23	-	-	-	
	Br-	mg/l	-	-	-	1.51	-	-	2.11	0.036	-	-	-	
	NO3-	mg/l	-	-	-	84.8	-	-	81	120	-	-	-	
	SO42-	mg/l	-	-	-	0.0592	-	-	0.0312	0.429	-	-	-	
	Fe	mg/l	-	-	-	12.4	-	-	12.3	13.1	-	-	-	
	Mg	mg/l	-	-	-	0.129	-	-	0.249	0.354	-	-	-	
	Mn	mg/l	-	-	-	5.54	-	-	5.41	5.01	-	-	-	
	K	mg/l	-	-	-	11.5	-	-	12	11.8	-	-	-	
	Na	mg/l	-	-	-	77.4	-	-	66.9	62.1	-	-	-	
	Ca	mg/l	-	-	-	0.0155	-	-	0.0286	0.0144	-	-	-	
	Cr	mg/l	-	-	-	0.0002	-	-	0.0002	0.000153	-	-	-	
	Pb	mg/l	-	-	-	0.00973	-	-	0.0062	0.00253	-	-	-	
	As	mg/l	-	-	-	-	-	-	-	-	-	-	-	

bold=non-detect

Table 4 Groundwater Analyses from the Treatability Test Injection Wells (Page 1 of 2).

HEIS No. Well No. Analyte	7/5/2005	9/8/2005	9/8/2005	9/8/2005	9/8/2005	9/20/2005	9/20/2005	9/20/2005	9/20/2005	11/2/2005	11/2/2005	11/2/2005
B1DF32	B1DX07	B1DX04	B1DX05	B1DX06	NA	NA	NA	NA	NA	B1F8R7	B1F8R8	B1F8R9
Feed to ext. wells	K-133	K-134	K-135	K-136	K-133 balled	K-134 balled	K-135 balled	K-136 balled	K-133 balled	K-134 balled	K-135 balled	K-136 balled
Cr+6	-	-	-	-	-	-	-	-	-	-	-	-
NO2-	0.058	-	-	-	-	-	-	-	-	-	-	-
NO3-	0	-	-	-	-	-	-	-	-	-	-	-
SO42-	-	-	-	-	-	-	-	-	-	-	-	-
pH	8.270	-	-	-	10.389	10.463	10.358	10.324	10.034	10.017	9.554	9.316
Temp	22.5	-	-	-	20.4	20.8	20.4	20.4	17.6	17.7	18	17.5
Cond	450	-	-	-	1526	1587	1587	2120	827	765	1143	526
DO	6.7	-	-	-	0.2	0.7	0.7	0.3	0.4	0.4	0.7	1.2
ORP	-105.2	-	-	-	-461.5	-454.4	-440.5	-455.7	-443.4	-431	-425.5	-408.5
WSCF Analyses												
Cr+6	NA	NA	NA	NA	-	-	-	-	-	B1F8R3	B1F8R4	B1F8R5
Alkalinity	6100	250	380	200	350	350	350	350	32	25	26	17
TOC	0.3	5.22	3.1	0.3	0.3	0.3	0.3	0.3	12	8.45	38.8	15.4
Cl-	13.3	6.83	22.7	12.6	14.7	14.7	14.7	14.7	12.8	24.5	17.5	19.3
NO2-	1.21	1.97	1.97	1.97	1.97	1.97	1.97	1.97	1.97	1.97	1.97	1.97
Br-	18.1	18.7	18.7	18.7	18.7	18.7	18.7	18.7	18.7	18.7	18.7	18.7
NO3-	4.42	3.62	3.62	3.62	3.62	3.62	3.62	3.62	3.62	3.62	3.62	3.62
SO42-	75.5	123	131	86.4	127	127	127	127	122	104	124	63
Fe	0.021	0.674	16.9	0.296	0.635	0.635	0.635	0.635	0.93	0.21	0.331	0.21
Mg	11	0.852	19.6	0.794	1.66	1.66	1.66	1.66	1.04	0.502	0.579	1.51
Mn	0.0343	0.119	0.697	0.01	0.14	0.14	0.14	0.14	0.0618	0.011	0.0299	0.0207
K	5.39	2.5	3.71	3.77	4.25	4.25	4.25	4.25	3.21	2.77	4.6	3.67
Na	11.4	4.06	9.06	11	7.36	7.36	7.36	7.36	9.54	8.61	11.5	10.5
Ca	2090	521	624	493	676	676	676	676	174	139	231	86.6
Cr	0.8	0.0779	0.283	0.04	0.0479	0.0479	0.0479	0.0479	0.0132	0.00244	0.0035	0.00164
Pb	0.04	0.002	0.00243	0.002	0.002	0.002	0.002	0.002	0.0012	0.0012	0.0012	0.0012
As	0.08	0.004	0.0104	0.004	0.004	0.004	0.004	0.004	0.00271	0.00224	0.00485	0.0003

bold=non-detect
NA=Not Analyzed

Table 5 Groundwater Analyses from the Treatability Test Injection Wells (Page 2 of 2).

HEIS No. Well No. Analyte	12/6/2005 B1H4K4 K-133 bailed	12/6/2005 B1H4K5 K-134 bailed	12/6/2005 B1H4K6 K-135 bailed	12/6/2005 B1H4K7 K-136 bailed	1/5/2006 B1HB55 K-133 bailed	1/5/2006 B1HB56 K-134 bailed	1/5/2006 B1HB57 K-135 bailed	1/5/2006 B1HB58 K-136 bailed	2/8/2006 B1HLK3 199-K-133 Bailed	2/8/2006 B1HLK4 199-K-134 Bailed	2/8/2006 B1HLK5 199-K-135 Bailed	2/8/2006 B1HLK6 199-K-136 Bailed
Cr+6	NA	NA	NA	NA	NA	NA	NA	NA	NA	NA	NA	NA
NO2-	NA	NA	NA	NA	NA	NA	NA	NA	NA	NA	NA	NA
NO3-	NA	NA	NA	NA	NA	NA	NA	NA	NA	NA	NA	NA
SO42-	NA	NA	NA	NA	NA	NA	NA	NA	NA	NA	NA	NA
pH	10.069	10.28	10.075	9.568	9.894	10.116	10.005	9.249	9.584	10.197	9.97	8.935
Temp	17.2	17.2	17	16.4	18.4	18.6	18.5	17.3	19.2	19.1	18.9	18.3
Cond	683	643	979	431	711	570	853	341	622	472	826	314
DO	0.4	0.7	1.1	1.8	2.9	5.4	6.2	15.5	3.5	6.7	6.1	19.6
ORP	-386.4	-384.7	-311.3	-302.2	-325.1	-352.3	-342.9	-276.7	-328.7	-338.6	-336.6	-251.2
WSCF Analyses	B1H4J9	B1H4K0	B1H4K1	B1H4K2	B1HB50	B1HB51	B1HB52	B1HB53	B1HLK8	B1HLK9	B1HLL0	B1HLL1
Cr+6	NA	NA	NA	NA	10	10	10	10	50	50	50	10
Alkalinity	26	30	19	16	26	26	24	26	20	190	16	67
TOC	13.8	6.09	20.6	8.74	5.42	3.08	20.2	7.53	29.6	5.1	12.4	6.63
Cl-	9.69	14.4	15.7	9.95	9.94	14.8	11.9	9.98	9.88	10.7	11.9	8.79
NO2-	1.66	1.01	1.48	0.049	1.24	1.99	0.962	0.049	0.59	482	0.62	0.049
Br-	0.465	0.465	0.465	0.465	0.465	0.465	0.465	0.465	0.465	0.465	0.465	0.465
NO3-	0.09	0.09	0.261	0.09	0.09	0.09	0.09	0.09	0.09	0.09	0.09	0.09
SO42-	124	88.5	147	76.5	146	98.4	187	67.8	152	83.3	212	70.3
Fe	0.437	1.54	1.25	2.02	0.892	0.422	0.474	0.316	1.53	2.99	2.44	7.89
Mg	0.374	1.33	1.87	4.84	2.38	1.66	1.44	4.53	1.98	4.44	3.52	13.3
Mn	0.0237	0.0827	0.0568	0.318	0.0381	0.0214	0.0216	0.164	0.0405	0.113	0.0727	0.85
K	3.2	4.14	1.1	2.48	1.1	1.1	1.26	1.1	3.04	2.18	4.1	5.05
Na	7.32	10.6	8.65	10.5	6.71	8.28	9.72	9.62	7.04	8.94	10	10.7
Ca	139	193	146	159	130	91.3	160	51.6	130	102	177	106
Cr	0.00616	0.019	0.00885	0.045	0.0148	0.00586	0.00528	0.00474	0.0122	0.0232	0.0139	0.044
Pb	0.000117	0.000256	0.000426	0.000778	0.000441	0.000265	0.000345	0.000166	0.0129	0.00116	0.00132	0.00332
As	0.00506	0.00367	0.00625	0.00443	0.0202	0.0159	0.0153	0.00375	0.0042	0.0047	0.00373	0.00546

bold=non-defect
NA=Not Analyzed

This page intentionally left blank.

APPENDIX C

FLOW DATA FROM TREATABILITY TEST

This page intentionally blank.

Table 6 Flow Data From Treatability Test. CPS=calcium polysulfide;
NR=no reading.

Date/time of Reading	Approx. Drawdown, K-126, ft	CPS, gpm	↳ CPS, gal	% CPS	K-126, gal	K-133, gpm	K-134, gpm	K-135, gpm	K-136, gpm	Cumulative, K-126, gal	Cumulative Injection, gal
6/28/05 0:00	NR	NR	81	NR	NR	NR	NR	NR	NR	NR	NR
6/28/05 17:35	NR	NR	756	NR	NR	NR	NR	NR	NR	NR	NR
6/29/05 11:00	3.22	1.65	2792	7.17%	15.75	3.75	3.36	5.43	3.52	38923	35722
6/29/05 13:00	3.20	1.38	2958	7.25%	15.84	2.80	2.82	5.74	3.45	40824	37666
6/29/05 14:26	3.20	1.41	3079	7.30%	15.93	4.04	2.08	4.92	4.47	42194	39121
6/30/05 7:42	3.21	1.43	4564	7.77%	15.98	4.72	1.81	5.23	4.45	58750	57399
6/30/05 9:24	3.19	1.34	4701	7.80%	15.19	4.54	0.63	4.90	4.26	60299	58998
6/30/05 12:05	3.50	1.10	4878	7.82%	12.68	2.29	4.22	4.41	2.26	62340	61297
6/30/05 17:10	3.24	1.42	5310	7.91%	15.60	3.76	5.40	2.22	5.09	67098	66750
6/30/05 17:44	NR	1.24	5352	7.98%	0.00	0.00	0.00	0.00	0.00	67098	66750
7/1/05 7:40	3.31	1.44	6556	8.18%	15.66	2.82	3.51	4.19	2.07	80192	78479
7/1/05 7:54	NR	1.00	6570	8.19%	0.00	0.00	0.00	0.00	0.00	80192	78479
7/1/05 9:26	3.31	1.58	6715	8.21%	17.37	0.96	1.04	5.49	1.96	81790	79493
7/1/05 11:41	NR	1.39	6902	8.44%	0.00	0.00	0.00	0.00	0.00	81790	79493
7/1/05 11:52	3.27	1.64	6920	8.25%	193.00	3.85	6.09	4.84	4.58	83913	79724
7/2/05 8:56	3.33	1.42	8714	8.47%	15.04	4.66	3.95	3.53	1.97	102924	99352
7/3/05 8:12	5.97	1.41	10681	8.91%	12.18	5.85	3.71	2.05	2.55	119922	121098
7/3/05 9:12	6.10	0.82	10730	8.91%	8.77	3.50	3.39	0.00	0.00	120448	121536
7/3/05 11:40	6.41	1.14	10899	8.95%	9.36	5.79	3.85	0.00	0.00	121833	123047
7/3/05 13:47	6.64	0.99	11025	8.98%	7.67	5.65	3.00	0.00	0.00	122807	124208
7/3/05 14:24	6.45	1.08	11065	8.97%	15.86	3.77	3.03	0.00	0.00	123394	124480
7/5/05 10:40	6.61	0.01	11089	8.94%	0.25	0.00	0.07	0.00	0.00	124067	124661
7/5/05 13:40	9.74	0.15	11116	8.92%	2.77	0.00	0.00	0.00	0.00	124565	124661
7/6/05 7:14	9.81	0.00	11116	8.92%	0.00	0.00	0.00	0.00	0.00	124565	124661
7/11/05 11:58	9.86	0.00	11122	8.89%	0.08	0.00	0.00	0.00	0.00	125161	124661
7/12/05 8:00	5.23	0.00	11126	8.88%	0.07	0.00	0.00	0.00	0.00	125245	124661
7/12/05 8:20	2.35	0.35	11133	8.87%	12.55	0.00	0.00	0.00	0.00	125496	124661
7/12/05 10:05	0.00	0.77	11214	8.79%	19.50	0.00	0.00	0.00	0.00	127544	124661
7/12/05 11:02	0.02	1.11	11277	8.76%	20.89	1.36	1.66	1.86	0.94	128735	125055
7/12/05 14:00	4.94	0.73	11407	8.71%	12.64	0.35	4.91	4.72	3.42	130985	127570
7/12/05 15:30	1.92	0.63	11464	8.67%	12.44	2.65	5.96	6.03	3.07	132185	129220
7/12/05 16:33	1.87	0.98	11526	8.63%	18.22	5.06	5.44	6.44	3.40	133525	130563
7/13/05 7:33	3.29	0.94	12375	8.20%	18.06	4.87	3.73	5.71	3.33	150945	147289
7/13/05 8:45	2.41	1.08	12453	8.18%	19.03	0.56	5.67	5.72	1.22	152315	148315
7/13/05 9:47	2.50	1.15	12524	8.16%	19.19	5.29	5.59	6.56	4.79	153475	149763
7/13/05 13:12	2.99	1.20	12769	8.11%	19.64	5.10	5.30	6.25	4.50	157375	154343
7/13/05 14:00	2.61	1.10	12822	8.10%	18.19	5.48	5.78	6.28	4.88	158205	155472
7/14/05 7:00	5.47	1.30	14151	8.09%	22.44	4.13	4.33	5.43	3.73	174845	174756
7/14/05 7:45	4.78	1.16	14203	8.10%	23.20	4.09	4.29	5.39	3.49	175425	175584
7/14/05 9:15	5.06	1.24	14315	8.10%	25.69	4.21	4.41	5.51	3.51	176705	177284
7/14/05 10:20	5.23	1.28	14398	8.11%	25.55	2.32	2.22	4.32	5.02	177605	178269
7/14/05 12:00	5.65	0.54	14452	8.08%	23.09	2.23	6.33	2.93	3.33	178845	179807
7/14/05 13:42	5.97	1.23	14577	8.09%	23.56	1.41	6.31	5.31	4.21	180145	181689
7/19/05 9:45	6.20	0.01	14624	7.77%	0.23	0.30	0.30	0.30	0.30	188205	190139
7/19/05 13:30	6.35	0.29	14689	7.75%	7.96	2.82	0.00	2.57	1.07	189425	191642
7/20/05 10:14	4.94	0.03	14721	7.70%	0.66	0.00	0.00	1.01	0.00	191185	192902
7/20/05 14:12	2.34	0.38	14812	7.67%	6.05	3.10	3.10	3.10	3.10	193175	195940
7/20/05 15:00	2.19	1.31	14875	7.66%	16.73	6.23	6.33	6.63	5.33	194285	197180
7/21/05 7:22	4.47	1.24	16088	7.58%	13.15	5.01	5.11	5.31	3.71	212325	217184
7/21/05 9:56	2.51	0.79	16210	7.55%	11.18	0.00	8.20	8.00	6.70	214705	220801
7/21/05 14:00	3.39	1.09	16477	7.51%	13.88	0.00	0.00	0.00	0.00	219295	220801
7/21/05 14:20	1.40	1.50	16507	7.51%	22.50	5.98	6.28	6.48	8.28	219895	221371
7/22/05 9:30	6.81	1.13	17805	7.47%	11.84	5.68	4.28	4.28	7.08	238395	247197
7/22/05 10:40	6.93	0.47	17838	7.46%	0.01	0.00	0.00	0.00	0.00	239005	247197
7/25/05 14:30	9.89	0.01	17878	7.30%	0.00	0.00	0.00	0.00	0.00	244785	247197
7/26/05 11:30	2.06	0.03	17920	7.29%	1.36	0.31	0.31	0.31	0.31	245945	248793

This page intentionally left blank.

DISTRIBUTION**Onsite**

13

**U.S. Department of Energy
Richland Operations Office**

B. L. Charboneau	H2-53
J. B. Morse (10)	A6-38
A. C. Tortoso	A6-38
DOE Public Reading Room	H2-53

Fluor Hanford, Inc.

10

J. V. Borghese	E6-35
D. B. Erb	E6-35
K. A. Hedquist	S0-01
R. L. Jackson	E6-35
S. W. Petersen	E6-35
J. G. Riddelle	E6-35
K. K. Schneider (3)	E6-35
L. C. Swanson	E6-35

2

Pacific Northwest National Laboratory

J. S. Fruchter	K6-96
Hanford Technical Library	P8-55

1

Lockheed Martin Information Technology

Document Processing Center	H6-08
----------------------------	-------

This page intentionally left blank.