

FINAL REPORT

1,4-Dioxane Remediation by Extreme Soil Vapor Extraction (XSVE)

ESTCP Project ER-201326

JANUARY 2018

Robert E. Hinchee
Integrated Science & Technology, Inc.

Paul C. Johnson
Colorado School of Mines

Paul R. Dahlen
Arizona State University

David R. Burris
Integrated Science & Technology, Inc.

David Becker
US Army Corps of Engineers

Distribution Statement A
This document has been cleared for public release



Page Intentionally Left Blank

This report was prepared under contract to the Department of Defense Environmental Security Technology Certification Program (ESTCP). The publication of this report does not indicate endorsement by the Department of Defense, nor should the contents be construed as reflecting the official policy or position of the Department of Defense. Reference herein to any specific commercial product, process, or service by trade name, trademark, manufacturer, or otherwise, does not necessarily constitute or imply its endorsement, recommendation, or favoring by the Department of Defense.

Page Intentionally Left Blank

REPORT DOCUMENTATION PAGE

Form Approved
OMB No. 0704-0188

The public reporting burden for this collection of information is estimated to average 1 hour per response, including the time for reviewing instructions, searching existing data sources, gathering and maintaining the data needed, and completing and reviewing the collection of information. Send comments regarding this burden estimate or any other aspect of this collection of information, including suggestions for reducing the burden, to Department of Defense, Washington Headquarters Services, Directorate for Information Operations and Reports (0704-0188), 1215 Jefferson Davis Highway, Suite 1204, Arlington, VA 22202-4302. Respondents should be aware that notwithstanding any other provision of law, no person shall be subject to any penalty for failing to comply with a collection of information if it does not display a currently valid OMB control number.

PLEASE DO NOT RETURN YOUR FORM TO THE ABOVE ADDRESS.

1. REPORT DATE (DD-MM-YYYY) 24-01-2018		2. REPORT TYPE ESTCP Final Report		3. DATES COVERED (From - To) 8/8/2013 - 8/8/2018	
4. TITLE AND SUBTITLE 1,4-Dioxane Remediation by Extreme Soil Vapor Extraction (XSVE)				5a. CONTRACT NUMBER Contract: 13-C-0059	
				5b. GRANT NUMBER	
				5c. PROGRAM ELEMENT NUMBER	
				5d. PROJECT NUMBER ER-201326	
6. AUTHOR(S) Robert E. Hinchee Paul C. Johnson Paul R. Dahlen David R. Burris David Becker				5e. TASK NUMBER	
				5f. WORK UNIT NUMBER	
				8. PERFORMING ORGANIZATION REPORT NUMBER ER-201326	
7. PERFORMING ORGANIZATION NAME(S) AND ADDRESS(ES) Integrated Science and Technology, Inc. 3301 Windy Ridge Parkway, Suite 250 Atlanta, GA 30339				10. SPONSOR/MONITOR'S ACRONYM(S) ESTCP	
9. SPONSORING/MONITORING AGENCY NAME(S) AND ADDRESS(ES) Environmental Security Technology Certification Program 4800 Mark Center Drive, Suite 17D03 Alexandria, VA 22350-3605				11. SPONSOR/MONITOR'S REPORT NUMBER(S) ER-201326	
				12. DISTRIBUTION/AVAILABILITY STATEMENT Distribution A; unlimited public release	
13. SUPPLEMENTARY NOTES					
14. ABSTRACT Extreme Soil Vapor Extraction (XSVE) is an enhancement of SVE to specifically addresses 1,4-dioxane contaminated vadose zone soil by incorporating enhancements such as decreased infiltration, increased air flow, focused vapor extraction, and injection of heated air. Removal of 1,4-dioxane from the vadose zone cuts off contamination to groundwater. An XSVE field demonstration at Former McClellan AFB, CA removed ~95% of 1,4-dioxane from the treatment zone after about a year of operation. The XSVE system was comprised of a square of 4 injection wells with a central extraction well. Injection wells heated ambient air to 120 C. ~10,000 Pore volumes were extracted during operation. A screening-level model (HypeVent XSVE) was developed as feasibility assessment and design tool for implementing XSVE. HypeVent XSVE sensitivity analyses showed that 1,4-dioxane removal could be further enhanced by injection of heated air with higher humidities. XSVE is a cost-effective remediation technology for 1,4-dioxane in the vadose zone.					
15. SUBJECT TERMS 1,4-dioxane soil vapor extraction heated air injection screening-level model focused vapor extraction soil remediation					
16. SECURITY CLASSIFICATION OF:			17. LIMITATION OF ABSTRACT UNCLASS	18. NUMBER OF PAGES 235	19a. NAME OF RESPONSIBLE PERSON Robert E. Hinchee
a. REPORT UNCLASS	b. ABSTRACT UNCLASS	c. THIS PAGE UNCLASS			19b. TELEPHONE NUMBER (Include area code) (850)984-4460

Page Intentionally Left Blank

FINAL REPORT

Project: ER201326

TABLE OF CONTENTS

	Page
EXECUTIVE SUMMARY	ES-1
1.0 INTRODUCTION	1
1.1 BACKGROUND	1
1.2 OBJECTIVES OF THE DEMONSTRATION	3
1.3 REGULATORY DRIVERS	4
2.0 TECHNOLOGY	5
2.1 TECHNOLOGY DESCRIPTION	5
2.2 ADVANTAGES AND LIMITATIONS OF THE TECHNOLOGY	6
3.0 PERFORMANCE OBJECTIVES	7
3.1 QUANTITATIVE PERFORMANCE OBJECTIVE: REDUCTION IN SOIL 1,4-DIOXANE	7
3.1.1 Data Requirements.....	8
3.1.2 Success Criteria.....	8
3.2 QUANTITATIVE PERFORMANCE OBJECTIVE: MINIMIZATION OF DOWNWARD MIGRATION OF 1,4-DIOXANE	8
3.2.1 Data Requirements.....	8
3.2.2 Success Criteria.....	8
3.3 QUALITATIVE PERFORMANCE OBJECTIVE: ADEQUATE SOIL GAS 1,4-DIOXANE MEASUREMENTS AT ELEVATED TEMPERATURES	8
4.0 SITE DESCRIPTION	11
4.1 SITE SELECTION	11
4.2 SITE LOCATION AND HISTORY	11
4.3 SITE GEOLOGY/HYDROGEOLOGY	12
4.4 CONTAMINANT DISTRIBUTION	12
5.0 TEST DESIGN	25
5.1 CONCEPTUAL EXPERIMENTAL DESIGN	25
5.2 BASELINE CHARACTERIZATION ACTIVITIES.....	31
5.3 LABORATORY STUDY RESULTS	34
5.3.1 1,4-Dioxane Soil Vapor Sampling at Elevated Temperatures	34
5.4 DESIGN AND LAYOUT OF TECHNOLOGY COMPONENTS	39
5.5 FIELD TESTING	42
5.6 SAMPLING METHODS	43
5.7 SAMPLING RESULTS	44
5.7.1 1,4-Dioxane Soil Vapor Sampling Methodology	44
5.7.2 XSVE System Monitoring.....	48

TABLE OF CONTENTS (Continued)

	Page
5.7.3 Post-Demonstration Soil Sampling.....	57
5.8 HYPEVENT XSVE FOR 1,4-DIOXANE	60
5.8.1 Overview.....	60
5.8.2 HypeVent XSVE Screening-Level Calculations	61
5.8.3 HypeVent XSVE Theory	62
5.8.4 HypeVent XSVE Use Instructions.....	65
5.8.5 Example HypeVent XSVE Application: Demonstration Site.....	68
5.8.6 HypeVent XSVE Application to Demonstration Site – Sensitivity Analysis.....	73
5.9 1-DIMENSIONAL XSVE: EXPERIMENTAL AND MODEL RESULTS.....	78
6.0 PERFORMANCE ASSESSMENT	89
6.1 QUANTITATIVE: REDUCTION IN SOIL 1,4-DIOXANE.....	89
6.2 QUANTITATIVE: MINIMIZATION OF 1,4-DIOXANE DOWNWARD MIGRATION	89
6.3 QUALITATIVE: ADEQUATE SOIL GAS 1,4-DIOXANE MEASUREMENTS AT ELEVATED TEMPERATURES	89
6.4 QUALITATIVE: EASE OF XSVE SYSTEM INSTALLATION AND STARTUP	89
6.5 QUALITATIVE: EASE OF XSVE SYSTEM OPERATION AND MONITORING	90
6.6 QUALITATIVE: UPDATED HYPEVENT AS A USEFUL TOOL IN XSVE SYSTEM DESIGN AND IMPLEMENTATION	90
7.0 COST ASSESSMENT.....	91
7.1 COST MODEL.....	91
7.1.1 Capital Costs	92
7.1.2 Operations & Maintenance Costs	92
7.1.3 Demonstration Specific Costs.....	92
7.2 COST DRIVERS	92
7.2.1 General Considerations.....	92
7.2.2 Competing Treatment Technologies.....	93
7.3 COST ANALYSIS	93
7.3.1 Base Case.....	94
7.3.2 Excavation Using Traditional Methods	95
7.3.3 Excavation Using Large Diameter Augers	96
8.0 IMPLEMENTATION ISSUES	99
8.1 APPLICABLE REGULATIONS	99
8.2 END USERS.....	99
9.0 REFERENCES	101
APPENDIX A BORING LOGS	A-1
APPENDIX B AECOM, 2016, OPERABLE UNIT D LANDFILL CAP INSPECTION AND MAINTENANCE REPORT.....	B-1

LIST OF FIGURES

	Page
Figure 1.1.1. Vapor Pressure of Water and 1,4-dioxane as a Function to Temperature (Crenshaw et al., 1938; Stull, 1947).	2
Figure 1.1.2. Vapor-liquid Equilibrium Curve for 1,4-dioxane-water System (Subbaiah, 1993). 2	2
Figure 1.1.3. 1,4-Dioxane Henry’s Law Constant (dimensionless; vapor/aqueous) as a Function of Temperature (Ondo and Dohnal, 2007).	3
Figure 2.1.1. Schematic Illustrating the Enhancements in XSVE to Improve the Removal of 1,4-dioxane over Traditional SVE.	5
Figure 4.2.1. Former McClellan AFB, Located near Sacramento, CA	11
Figure 4.4.1. 2004 Facility-wide VOC Distributions in Groundwater (left) and Soil Vapor (right).	13
Figure 4.4.2. OU-D SVE System Cumulative Mass Removed for Primary VOCs.	13
Figure 4.4.3. OU-D SVE System Mass Removal Rates for Primary VOCs Including 1,4-dioxane.	14
Figure 4.4.4. Baseline (1996) and Current (2013) OU-D Soil Gas Total VOCs.	15
Figure 4.4.5. Overlay of Historical Disposal Trenches within OU-D Northern Area with SVE System and Soil Gas Monitoring Network Showing the Locations of VES-105 and VES-101	16
Figure 4.4.6. OU-D 1,4-dioxane Soil Gas Concentrations Observed in 2013 prior to this Demonstration Project	17
Figure 4.4.7. 2013 OU-D Shallow Groundwater Zone 1,4-dioxane Concentrations	18
Figure 4.4.8. Schematic of PneuLog [®] Profiling Operation (Praxis Environmental Technologies, Inc.) and Photograph of Field Equipment.	19
Figure 4.4.9. VES-105 PneuLog [®] Profiling Results Showing Estimated Soil Gas Concentrations (ppm _v) for 1,4-dioxane and TCA; and Effective Air Permeability (scfm/ft/inH ₂ O). 20	20
Figure 4.4.10. VES-101 PneuLog [®] Profiling Results Showing Estimated Soil Gas Concentrations (ppm _v) for 1,4-dioxane and TCA; and Effective Air Permeability (scfm/ft/inH ₂ O). 21	21
Figure 4.4.11. Correlation Analysis between GC (Tedlar bags) and TO-15 (Summa canisters) for 1,4-dioxane and TCA.	22
Figure 4.4.12. VES-105 Cumulative Mass Removed for Primary VOCs.	23
Figure 4.4.13. VES-105 Mass Removal Rates for Primary VOCs and 1,4-dioxane.	23
Figure 5.1.1. Plan View Schematic of Conceptual XSVE Demonstration Layout.	26

LIST OF FIGURES

	Page
Figure 5.1.2. Plan View Conceptual Schematic of Soil Borings to Be Taken before and after XSVE Demonstration showing the Three Zones Used for Incremental Sampling	27
Figure 5.1.3. Experimentally Determined Henry’s Law Constants (H_i) for 1,4-dioxane in Soil under Varying Conditions of Soil Moisture and 1,4-dioxane Concentration.....	28
Figure 5.1.4. Preliminary Screening-level Model Projected Ideal Performance under XSVE Conditions at 90°C Injection Temperature.	30
Figure 5.1.5. Preliminary Bench-scale (column) Venting Test Run Results under Ambient Conditions.	31
Figure 5.2.1. Extraction, Injection and Vapor Monitor Well Locations Relative to VES-105.	32
Figure 5.2.2. Geologic Cross-section for VMW-4 to VMW-2 Transect.	32
Figure 5.2.3. Estimated 1,4-dioxane Soil Concentrations (mg/kg) Based on On-site Field Analysis by Triad Environmental Solutions, Inc.	33
Figure 5.2.4. 1,4-Dioxane Soil Concentrations (mg/kg) prior to XSVE Operation.	33
Figure 5.2.5. Soil Moisture Concentrations (%) prior to XSVE Operation.....	34
Figure 5.3.1. Schematic of Vapor/condensate Sampling Apparatus showing Purge, Condensate Collection and Vapor Sampling Modes.	36
Figure 5.3.2. Vapor/Condensate Sampling Apparatus as Used in the Field (left). Ice Bath Condensate Coil Mockup with Stopper and VOA Condensate Collection Vessel Is Shown on Right.....	37
Figure 5.3.3. 1,4-Dioxane Mass for Condensate and Vapor Phases per Hour in Vapor Generator (18.5 mg/L 1,4-dioxane Sparged at Specified Temperature) Sampled Using Vapor/Condensate Sampling Apparatus at 1.0 L/min.....	38
Figure 5.3.4. 1,4-Dioxane Henry’s Constants Obtained at Different Temperatures for this Project (closed circles) Compared with those of Ondo and Dohnal, 2007 (solid line).....	38
Figure 5.4.1. Well Construction and Instrumentation Details for XSVE Demonstration.	39
Figure 5.4.2. Schematic of XSVE Demonstration System Design.....	40
Figure 5.4.3. VMW Instrumentation	41
Figure 5.4.4. Injection Wellheads.....	41
Figure 5.4.5. Layout of XSVE Demonstration Site.....	42
Figure 5.7.1. 1,4-Dioxane Concentrations (mg/m^3) Obtained Using Vapor/Condensate Sampling Apparatus during XSVE Operation.	45
Figure 5.7.2. 1,4-Dioxane Mass Fraction in Condensate vs. 1,4-dioxane Concentration (mg/m^3) Obtained Using Vapor/Condensate Sampling Apparatus During XSVE Operation for Samples with Detections in Both Vapor and Condensate Phases.	45

LIST OF FIGURES

	Page
Figure 5.7.3. 1,4-Dioxane Mass Fraction in Condensate at Different Temperatures for Laboratory (open circles; dashed line) and Field (solid circles) Samples Collected During XSVE Operation.	46
Figure 5.7.4. Comparison of 1,4-dioxane Concentrations Obtained Using: 1) Vapor/Condensate Sampling Apparatus at Well Head and 2) Canister (Without ice bath) After Air-water Separator.	47
Figure 5.7.5. Extraction Well 1,4-dioxane Concentrations Taken Using 1) Vapor/Condensate Sampling Apparatus and 2) Vapor Canister Only (No Ice Bath).	48
Figure 5.7.6. GAC Blower (to Injection Well Manifold) Flow Rates and Pressures during XSVE Operation.	48
Figure 5.7.7. Injection Well Flow Rates and Pressures During XSVE Operation.	49
Figure 5.7.8. Extraction Well Flow Rates and Pressures (after AWS) During XSVE Operation. 49	49
Figure 5.7.9. Injection Well Temperatures at the Wellhead and Mid-screen During XSVE Operation.	50
Figure 5.7.10. Outer (VMW-2 and -4) and Inner Ring (VMW-1 and -3) Treatment Zone Temperatures for During XSVE Operation.	51
Figure 5.7.11. Extraction Well Temperatures During XSVE Operation.	51
Figure 5.7.12. Outer (VMW-2 and -4) and Inner Ring (VMW-1 and -3) Treatment Zone Soil Moisture Contents for During XSVE Operation.	52
Figure 5.7.13. Outer (VMW-2 and -4) and Inner Ring (VMW-1 and -3) Treatment Zone Pressures for During XSVE Operation.	53
Figure 5.7.14. Outer (VMW-2 and -4) and Inner Ring (VMW-1 and -3) Treatment Zone 1,4-dioxane Concentrations (mg/m ³) in Soil Gas for During XSVE Operation.	54
Figure 5.7.15. Extraction Well 1,4-dioxane Soil Vapor Concentrations During XSVE Operation. 54	54
Figure 5.7.16. 1,4-Dioxane Mass Removal Rates and Cumulative Mass Removed During XSVE Operation.	55
Figure 5.7.17. 1,4-Dioxane Mass Removal Rates and Cumulative Mass Removed During XSVE Operation Compared with Those for OU-D and VES-105.	55
Figure 5.7.18. Cumulative Condensate Volume (Air-water Separator and Piping Low-point Drain) During XSVE Operation.	56
Figure 5.7.19. Estimated Power Consumption During XSVE Operation.	56
Figure 5.7.20. Proportion of Estimated Power Consumption as Injected Heat During XSVE Operation.	56
Figure 5.7.21. Proportion of Injected Heat Entering Treatment Zone During XSVE Operation. 57	57

LIST OF FIGURES

	Page
Figure 5.7.22. Proportion of Injected Heat Loss to Above Treatment Zone During XSVE Operation.	57
Figure 5.7.22. Locations of Post-demonstration Soil Borings.....	58
Figure 5.7.23. Split Spoon Cool Down Procedure During Post-demonstration Soil Sampling.	58
Figure 5.7.25. 1,4-Dioxane Soil Concentrations (mg/kg) Before (circle, dashed line) and After (square, solid line) XSVE Operation.....	59
Figure 5.7.26. Soil Moisture Concentrations (%) Before (circle, dashed line) and after (square, solid line) XSVE Operation.	59
Figure 5.8.1. Sample HypeVent XSVE Output (“Results – 1,4D Removal” worksheet tab). .	60
Figure 5.8.2. Simplified Conceptualization of the XSVE Treatment Process.....	61
Figure 5.8.3. Input Section of the HypeVent XSVE “HypeVent XSVE Inputs & Calcs”.	66
Figure 5.8.4. Time Step Entry Cell in “HypeVent XSVE Inputs & Calcs” Worksheet.	67
Figure 5.8.5. Sample HypeVent XSVE Output (“Results – Soil T and Water” chart).....	68
Figure 5.8.6. HypeVent XSVE Inputs for the Demonstration Site Application Example.	71
Figure 5.8.7. HypeVent XSVE 1,4-dioxane Removal Output for the Demonstration Site Application Example.....	72
Figure 5.8.8. HypeVent XSVE Soil Temperature and Soil Moisture Output for the Demonstration Site Application Example.....	72
Figure 5.8.9. HypeVent XSVE Soil Temperature and Soil Moisture Output for the Demonstration Site Application Example.....	73
Figure 5.8.10. HypeVent XSVE 1,4-dioxane Removal Output for the Demonstration Site Application Example, for Three Different Heating Scenarios.	74
Figure 5.8.11. HypeVent XSVE Soil Temperature and Soil Moisture Output for the Demonstration Site Application Example, for Three Different Heating Scenarios. 74	74
Figure 5.8.12. HypeVent XSVE 1,4-dioxane Removal Output for the Demonstration Site Application Example, for Three Different Soil Moisture Scenarios.	75
Figure 5.8.13. HypeVent XSVE Soil Temperature and Soil Moisture Output for the Demonstration Site Application Example, for Three Different Soil Moisture Scenarios.	75
Figure 5.8.14. HypeVent XSVE 1,4-dioxane Removal Output for the Demonstration Site Application Example, for Three Different Ambient Air Relative Humidity Scenarios.	76
Figure 5.8.15. HypeVent XSVE Soil Temperature and Soil Moisture Output for the Demonstration Site Application Example, for Three Different Ambient Air Relative Humidity Scenarios.....	77

LIST OF FIGURES

	Page
Figure 5.8.16. HypeVent XSVE 1,4-dioxane Removal Output for the Demonstration Site Application Example, for Four Different Injection Temperatures at 100% RH.	77
Figure 5.8.17. HypeVent XSVE Soil Temperature and Soil Moisture Output for the Demonstration Site Application Example, for Four Different Injection Temperatures at 100% RH.	78
Figure 5.9.1. Schematic of Column Setup for Fully Humidified Air at Injection Temperature.	79
Figure 5.9.2. Schematic of Column Setup for Injection of Ambient Air (with specified RH) Heated to Injection Temperature.	79
Figure 5.9.3. Temperature Profiles for Soil Temperatures at 5 cm (near inlet) and 40 cm (towards outlet) During Column Runs for Injections of Heated Ambient Air (25% RH) and 100% RH at Injection Temperature.	81
Figure 5.9.4. 1,4-Dioxane Elution Profiles During Column Runs for Injections of Heated Ambient Air (25% RH) and 100% RH at Injection Temperature.	81
Figure 5.9.5. 1,4-Dioxane Removal Rates and % Removal for Column Runs for Heated Ambient Air (25% RH).	82
Figure 5.9.6. 1,4-Dioxane Removal Rates and % Removal for Column Runs for 100% RH at Injection Temperature.	83
Figure 5.9.7. Temperature Profiles Generated by HypeVent XSVE Using Column Run Conditions for Injections of Heated Ambient Air (25% RH) and 100% RH at Injection Temperature.	84
Figure 5.9.8. 1,4-Dioxane Concentration Profiles Generated by HypeVent XSVE Using Column Run Conditions for Injections of Heated Ambient Air (25% RH) and 100% RH at Injection Temperature.	84
Figure 5.9.9. Experimental Column (solid) and Simulated (dashed) Soil Temperatures at Seven Heights along Soil Column for 50°C 100% RH Column Run.	86
Figure 5.9.10. Experimental Column and Simulated 1,4-dioxane Removal Rates (HypeVent XSVE and 1-D models) for the 50°C 100% RH Column Run.	86
Figure 5.9.11. Experimental Column and Simulated % 1,4-dioxane Removed (HypeVent and 1-D models) for the 50°C 100% RH Column Run.	87
Figure 5.9.12. 1-D finite Difference Model Simulations of 1,4-dioxane Soil Concentration (mg/kg) Profiles at Different Times during the 50°C 100% RH Column Run. ..	87

LIST OF TABLES

	Page
Table 3.1. Quantitative Performance Objective.....	7
Table 3.2. Qualitative Performance Objectives	7
Table 4.4.1. 4Q2013 OU-D SVE Operation (URS, 2014a).....	17
Table 4.4.2. 4Q2013 Select Chlorinated VOC Concentrations for OU-D Northern Area SVE Wells (AECOM Database, 2016).	18
Table 5.1.1. Preliminary Screening-Level Model Output Considered in the Test Design	29
Table 5.3.1. Results of Vapor Generator (~2 L 18.5 mg/L 1,4-dioxane Sparged at Specified Temperature) Sampled Using Vapor/Condensate Sampling Apparatus.....	37
Table 5.6.1. Approximate Total Number and Types of Samples Collected (excluding on-site analysis and PneuLog).	44
Table 5.7.1. XSVE Extraction Well Effluent 1,4-dioxane Concentrations Taken by 3 Methods: 1) Vapor/Condensate Sampling Apparatus Sampled at Wellhead; 2) Vapor and Condensate Sampled After Air/Water Separator; and 3) Sampled at Wellhead. .	47
Table 5.8.1. HypeVent XSVE Equations.....	63
Table 5.8.2. Nomenclature for HypeVent XSVE Equations Presented in Table 5.8.1.....	64
Table 5.9.1. Experimental Conditions for Bench-scale XSVE Column Tests.	80
Table 5.9.2. 1,4-Dioxane Treatment Performance Responses for Column Runs.	83
Table 5.9.3. Treatment Time Reductions (%) Relative to the 22°C 25% RH Column Run.....	83
Table 5.9.4. Input Parameters Used to Simulate Bench Scale XSVE 50°C 100% RH Column Run.....	85
Table 7.1.1. Cost Model for XSVE.....	91
Table 7.2.1. Cost Drivers to Consider for XSVE.....	93
Table 7.3.1. Cost Comparison between XSVE and Competing Technologies.	94
Table 7.3.2. Cost Detail for Traditional Excavation.	95
Table 7.3.3. Cost Detail for Excavation by Large Diameter Auger.....	97

ACRONYMS AND ABBREVIATIONS

AFB	Air Force Base
bgs	below ground surface
COC	Contaminant of concern
cm	centimeter
CY	Cubic Yards
DNAPL	Dense Non-aqueous phase liquid
DoD	Department of Defense
DoE	Department of Energy
ESTCP	Environmental Security Technology Certification Program
ft	feet
IDW	investigation-derived waste
ITRC	Interstate Technology and Regulatory Council
L	liter
m	meter
mg	milligram
NAPL	Non-aqueous phase liquid
PCE	Tetrachloroethylene (IUPAC); perchloroethylene (common)
PI	Principal Investigator
POC	Point of contact
ppb _v	parts per billion by volume (vapor concentration unit)
ppm _v	parts per million by volume (vapor concentration unit)
PRG	Preliminary Remediation Goal
RH	Relative humidity
Scfm	Standard cubic feet per minute
SHSO	Site health and safety officer
T	Temperature
TCA	1,1,1-trichloroethane
TCE	trichloroethene (IUPAC); trichloroethylene (common)
TLA	three letter acronym
TO-15	Toxic Organics-15 (USEPA analytical method)

USEPA United States Environmental Protection Agency

VOCs volatile organic compounds

Note: Terms used in HypeVent XSVE and its corresponding 1-dimensional model are described in Sections 5.8 and 5.9, respectively.

ACKNOWLEDGEMENTS

The demonstration site search process was greatly facilitated by Hunter Anderson, Ph.D. of the Air Force Civil Engineering Center. Assistance of the McClellan facility Groundwater and SVE Program Manager, Kenneth Smarke, Ph.D., P.E. in facilitating this project is appreciated. Successful field implementation of this project was largely accomplished by AECOM with Kimiye Touchi, P.E. as the project manager and Paul Graff, P.E. as oversight lead and, especially, AECOM field personnel. The work of Dr. Yaunming Guo of Arizona State University on the 1-dimensional XSVE experimental and model systems is gratefully acknowledged.

Page Intentionally Left Blank

EXECUTIVE SUMMARY

1,4-Dioxane is a cyclic diether that has often been found as an additive in the chlorinated solvent 1,1,1-trichloroethane. It has proven to be a persistent groundwater contaminant. Conventional soil vapor extraction (SVE) can remove some 1,4-dioxane, but a substantial residual source is left behind causing long-term groundwater contamination. Although 1,4-dioxane's vapor pressure in the range of trichloroethylene or benzene, it is totally miscible in water soluble. As a result, 1,4-dioxane becomes sequestered in vadose zone pore water which serves as a long-term source of groundwater contamination. Extreme Soil Vapor Extraction (XSVE) is an enhancement of SVE to specifically addresses 1,4-dioxane contaminated soil by incorporating enhancements such as decreased infiltration, increased air flow, focused vapor extraction, and injection of heated air.

The XSVE field demonstration site was at the former McClellan AFB near Sacramento, CA adjacent to an SVE well with high 1,4-dioxane concentrations. Vertical profiles of 1,4-dioxane vapor concentrations and effective permeabilities in SVE well were determined using Pneulog®. Field analysis of soil boring samples for 1,4-dioxane during drilling operations was conducted to insure suitable placement of injection and extraction wells for the demonstration. The XSVE system consists of four 2-inch steel cased injection wells forming a 20 foot square with a central 4-inch steel cased extraction well (38 to 68 ft bgs screened interval each). The treatment zone and soil beneath were instrumented with thermocouples, soil moisture sensors and soil vapor monitoring probes. 1,4-Dioxane and soil moisture distributions prior to XSVE using five soil borings. The system operated for ~13 months with ~98% uptime. Injection temperatures were maintained in the 100 to 130°C range (mid-screen) for the bulk of system operation, with flow rates generally in the 70 to 90 scfm range for each injection well. Extraction well flow rate was generally in the 70 to 110 scfm range. Observed treatment zone temperatures reached as high as 90°C near the injection wells, however extraction well temperatures did not exceed 40°C. Soil heating costs were ~\$25/CY for this demonstration. Soil moisture readings decreased significantly in the sensors closest to the injection wells, whereas those near the extraction well generally remained stable. Treatment zone and extraction well 1,4-dioxane vapor concentrations were determined using a vapor/condensate sampling apparatus due to elevated temperature soil gas having the potential to condense water vapor in ambient temperature vapor sampling canisters. Water condensation has the potential to removing 1,4-dioxane from the vapor. Approximately 13 kg 1,4-dioxane was removed from the treatment zone over the course of the demonstration.

Post-demonstration soil samples were collected using five soil borings. 1,4-Dioxane in the treatment zone decreased ~94% and soil moisture decreased ~45%. Downward migration of 1,4-dioxane due to condensation was not observed. A screening-level mass and energy balance model, HypeVent XSVE, was developed to simulate the remediation of 1,4-dioxane by XSVE. HypeVent XSVE adequately simulated 1,4-dioxane removal, soil moisture and soil temperatures observed during the demonstration. Sensitivity analyses showed that 1,4-dioxane removal benefited considerably from heated air injection. HypeVent XSVE as a useful feasibility assessment and design tool for XSVE of 1,4-dioxane. XSVE has been demonstrated to be a cost-effective remediation approach for vadose zone 1,4-dioxane.

Page Intentionally Left Blank

1.0 INTRODUCTION

Soil Vapor Extraction (SVE) has long been an accepted and widely used technology for remediation of VOC contaminated vadose zone. As a result most sites with vadose zone VOC contamination either have been subject to SVE or are likely candidates for SVE treatment. Unfortunately, 1,4-dioxane, a common VOC co-contaminant is not readily treated by conventional SVE. Enhanced or extreme soil vapor extraction (XSVE) is a form of SVE designed specifically to address 1,4-dioxane contaminated soil by incorporating enhancements such as increased air flow, increased temperature and focused vapor extraction. Successful implementation of the XSVE technology will allow cost effective application of the well-understood SVE technology for 1,4-dioxane treatment.

1.1 BACKGROUND

1,4-Dioxane contamination has been an emerging problem. The compound has historically been a stabilizer additive to chlorinated solvents, particularly 1,1,1-trichloroethane (TCA) (Mohr, 2010). 1,4-Dioxane is relatively volatile (38 mm Hg vapor pressure; i.e., 0.05 atmospheres), is completely miscible in water, and tends to be resistant to degradation. This combination of characteristics has resulted in extensive 1,4-dioxane groundwater plumes. Residual vadose zone 1,4-dioxane can leach to groundwater, thus serving as a long-term source area and prolonging the need for groundwater remediation efforts.

SVE is a proven technology for the removal of volatile organic compounds (VOCs) such as TCA from the vadose zone. However, since 1,4-dioxane is sequestered in the vadose zone water it is not effectively treated by conventional SVE.

In a recent data review from 49 Air Force installations, Anderson et al. (2012) found 1,4-dioxane in groundwater at about 20% of all chlorinated solvent sites and found a strong correlation with both TCE and TCA. In a recent review of the Navy's database, 1,4-dioxane was found at dozens of sites, and over 1,100 soil gas detections of 1,4-dioxane indicating substantial vadose zone presence. A recent review of GeoTracker (California State Water Resources Control Board data management system) showed ~100 sites with references to 1,4-dioxane.

There is currently no demonstrated approach for in situ remediation of vadose zone 1,4-dioxane. Excavation is an option where feasible. Other technologies such as in situ oxidation or bioremediation though possible are unproven. Data do exist that demonstrate the ability of conventional SVE to remove TCA from the vadose zone; however, current design and operational paradigms do not effectively address 1,4-dioxane. Conventional SVE designed to remove volatiles such as TCE or TCA often leaves substantial 1,4-dioxane behind to serve as a continued source of groundwater contamination.

Examination of vapor-liquid equilibria of the 1,4-dioxane-water system provides insights that are relevant to the vadose remediation of 1,4-dioxane sequestered in vadose zone water. 1,4-Dioxane and water pure compound vapor pressures of are similar as a function of temperature (Crenshaw et al., 1938; Stull, 1947; see Figure 1.1.1). However, the vapor-liquid equilibria of the 1,4-dioxane-water system is highly non-ideal, favoring higher relative 1,4-dioxane vapor concentrations compared to water when 1,4-dioxane is at low mole fractions in the aqueous phase (Subbaiah, 1993; see Figure 1.1.2). 1,4-Dioxane is present in the very low mole fraction range in environmental situations (Note: 1,000 mg/L 1,4-Dioxane is a mole fraction of 0.002 in water.). This results in the Henry's Law constant being higher than predicted by ideal behavior.

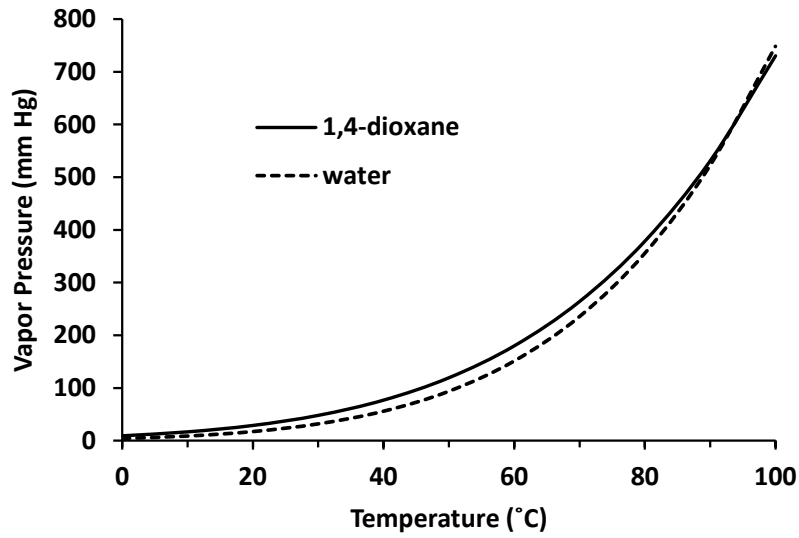

Figure 1.1.1. Vapor Pressure of Water and 1,4-dioxane as a Function to Temperature (Crenshaw et al., 1938; Stull, 1947).

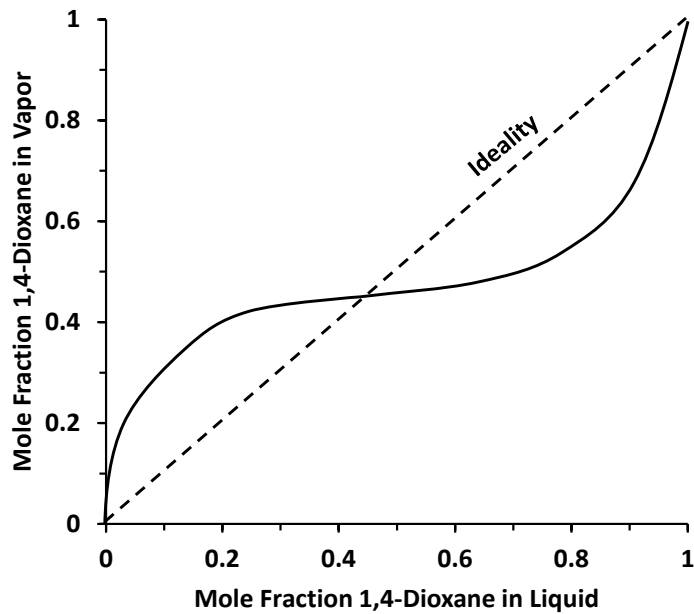

Figure 1.1.2. Vapor-liquid Equilibrium Curve for 1,4-dioxane-water System (Subbaiah, 1993).

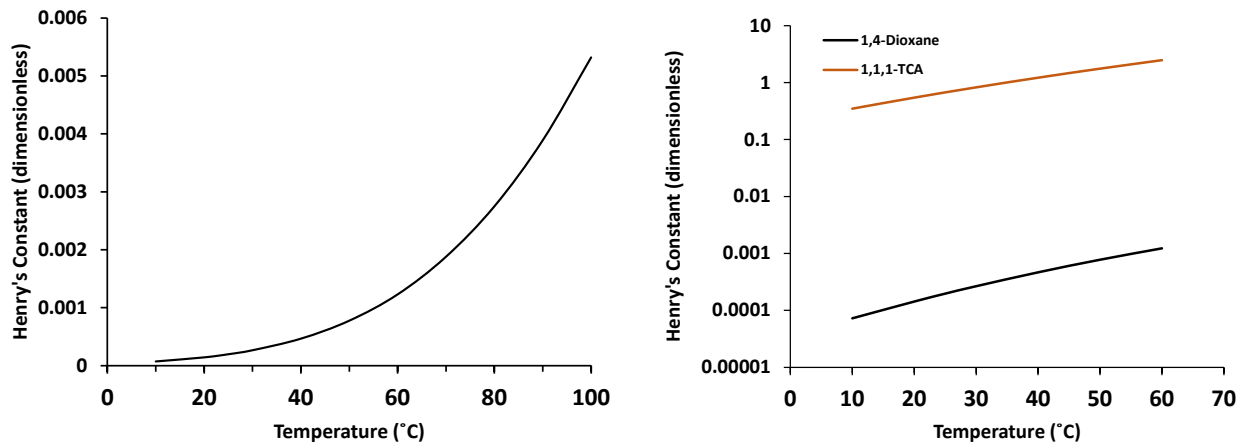

Figure 1.1.3. 1,4-Dioxane Henry’s Law Constant (dimensionless; vapor/aqueous) as a Function of Temperature (Ondo and Dohnal, 2007).

Henry’s Law constant for TCA (Sanders, 2015) is also shown for comparison.

The temperature-dependent 1,4-dioxane Henry’s Law constant is nonlinear and favors higher 1,4-dioxane concentrations in the vapor phase as temperature increases (Ondo and Dohnal, 2007; see Figure 1.1.3). Comparison with the TCA Henry’s constant illustrates why 1,4-dioxane remains behind after conventional SVE. The vapor-liquid equilibria for the 1,4-dioxane-water system indicates 1,4-dioxane removal from vadose zone water is feasible and that removal rates should increase as temperatures increase.

Limited reports indicating some success using aeration techniques to remediate 1,4-dioxane in groundwater are available. It is not clear to what extent these processes treat by supplying oxygen and stimulating biodegradation or by stripping the 1,4-dioxane from groundwater. Odah et al. (2005) report an in-well circulation technology treated 1,4-dioxane in groundwater. This in-well groundwater circulation technology involves aerating groundwater within a well and inducing groundwater flow into the deeper screen and out of the shallower screen. These results provide some indication of 1,4-dioxane removal from the aqueous phase by vapor partitioning. Similarly, modeling of in situ air sparging indicates substantial (> 50%) removal of 1,4-dioxane from groundwater by partitioning into the vapor phase is possible (Upal et al., 2014). These results also indicate that removal of 1,4-dioxane from vadose zone water by SVE should be feasible.

1.2 OBJECTIVES OF THE DEMONSTRATION

The primary objective of this project is to provide DoD and its contractors with the tools and information necessary to remediate 1,4-dioxane contaminated vadose soils. This demonstration project evaluated and demonstrated the efficacy of XSVE to remove 1,4-dioxane from the vadose zone, thus reducing the need for long-term groundwater remediation. An additional objective is to facilitate the implementation of the XSVE technology by developing guidance, including updating HyperVentilate (HypeVent) SVE guidance software (Johnson et al., 1990; Johnson 1992 and 1993; Johnson and Stabenau, 1993; USEPA, 1993) to simulate the effects of XSVE operation, thus providing a useful feasibility assessment and design tool for XSVE of 1,4-dioxane.

1.3 REGULATORY DRIVERS

1,4-Dioxane is an emerging contaminant of concern (COC) for which cleanup standards are only now being set; USEPA Region 9 (USEPA, 2015a & b) screening levels are 0.094 µg/kg for soil to groundwater and 0.46 µg/L for drinking water (tapwater). California has adopted a drinking water notification level for 1,4-dioxane of 1 µg/L (CA State Water Resources Control Board, 2015). New Hampshire has a ambient groundwater quality standard of 3 µg/L for 1,4-dioxane (NHDES, 2011).

Since 1,4-dioxane can leach from vadose zone sources for long periods of time yielding groundwater concentrations in the µg/L range. Regulators have been requiring groundwater remediation in addition to the cleanup of the original chlorinated VOCs. Development of cost-effective vadose zone 1,4-dioxane treatment is essential for DoD to meet their Response Complete goals (Response Complete at 90% of IRP sites by FY 2018).

2.0 TECHNOLOGY

2.1 TECHNOLOGY DESCRIPTION

XSVE is the extension of SVE to specifically address 1,4-dioxane contaminated soil. Conventional SVE is often the remediation technology of choice for the chlorinated solvents typically found with 1,4-dioxane. SVE is known to remove some 1,4-dioxane, but substantial residual is usually left behind. This is because, although 1,4-dioxane has a vapor pressure in the same range as trichloroethylene (TCE) or benzene, it is much more water-soluble, resulting in preferential partitioning into pore water rather than vapor. Existing site data show that although some 1,4-dioxane removal occurs during conventional SVE, cleanup is incomplete. This is because the focus of traditional SVE is on high vapor pressure/low solubility VOCs (see Figure 2.1.1).

XSVE solves this problem through a combination of focused vapor extraction, increased air flow, increased temperature, and decreased infiltration. All of these enhancements may not be required at every site. The XSVE enhancements focus on the removal of vadose 1,4-dioxane. Conventional SVE typically requires extraction of between 200 and 5,000 pore volumes and operation from 2 to 4 years (Army CoE, 2002). Without the XSVE enhancements, substantially more pore volumes would be required to remove significant 1,4-dioxane mass. Injection of heated near the extraction point reduces required pore volumes to achieve cleanup.

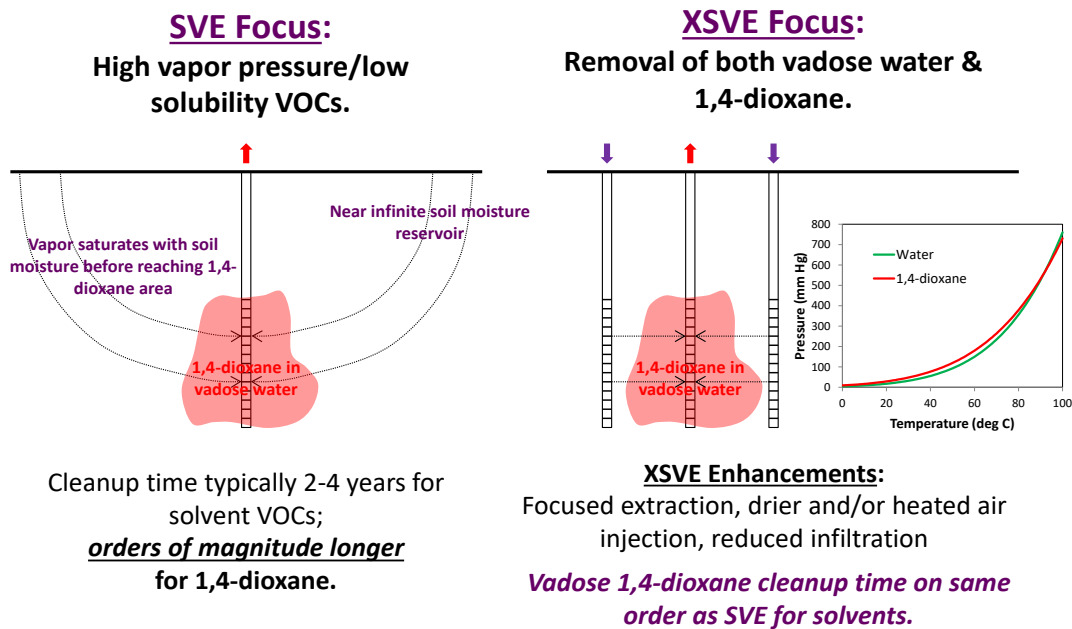

Figure 2.1.1. Schematic Illustrating the Enhancements in XSVE to Improve the Removal of 1,4-dioxane over Traditional SVE.

2.2 ADVANTAGES AND LIMITATIONS OF THE TECHNOLOGY

SVE is a widely used and effective remedial technology for VOCs. The processes related to successful operation of SVE for VOCs are well-understood. Hot air injection is known to enhance SVE (USEPA, 1997). XSVE is simply enhancing an existing, well-developed technology. Various technologies for hot air injection are available. Models such as HypeVent are available to aid in the design and operation of SVE systems.

The challenge of adequately locating the 1,4-dioxane source within the vadose zone is a potential disadvantage. A key aspect of XSVE is focused extraction which can only be accomplished if the location of 1,4-dioxane in the vadose zone is known. If there was one primary known location of chlorinated solvent release, analysis of soil boring samples in that release location should be able to determine where 1,4-dioxane is located. Experience has shown that the distribution of 1,4-dioxane can be much more confined than that of the chlorinated solvents as the 1,4-dioxane tends to stay closest to the release location, so knowing the release location is an advantage. If there are multiple unknown chlorinated solvent release locations, it may be difficult to cost-effectively determine the locations of 1,4-dioxane in the vadose zone to the degree necessary for effective focused extraction.

A potential disadvantage is that the dynamics of heating soil with injected air is not well understood; estimates and calculations can be made, but actual field data is lacking. This potential disadvantage is eliminated if hot air injection is not required. It may be cost-effective to have focused extraction for a longer period of time. However the HypeVent XSVE model (Section 5.8) indicates that evaporative cooling may negate the potential benefits of not heating.

3.0 PERFORMANCE OBJECTIVES

The quantitative and qualitative performance objectives for this technology demonstration are given in Tables 3.1 and 3.2, respectively.

Table 3.1. Quantitative Performance Objective

Performance Objective	Data Requirements	Success Criteria
Reduction in Soil 1,4-Dioxane	Soil 1,4-dioxane concentrations in soil borings within treatment zone prior to and after XSVE operation	> 90% Reduction in the average treatment zone soil 1,4-dioxane concentration
Minimization of 1,4-Dioxane Downward Migration	Soil 1,4-dioxane concentrations in soil borings below treatment zone prior to and after XSVE operation	< 20% Increase in average soil 1,4-dioxane soil concentration beneath treatment zone

Table 3.2. Qualitative Performance Objectives

Performance Objective	Data Requirements	Success Criteria
Adequate Soil Gas 1,4-Dioxane Measurements at Elevated Temperatures	Development of methods for accurate sampling and analysis of soil gas 1,4-dioxane concentrations before and during XSVE operation	Meaningful, comparable 1,4-dioxane soil gas data for process control over wide temperature range
Ease of XSVE System Installation and Startup	Input from field Project Team, including on-site contractor AECOM	Moderately more complex than traditional SVE system installation and startup
Ease of XSVE System Operation and Monitoring	Input from field Project Team, including on-site contractor AECOM	Moderately more complex than traditional SVE system operation and monitoring
Updated HypeVent as a Useful Tool in XSVE System Design and Implementation	Input from Project Team members	Updated is a valuable tool in XSVE system design and implementation

3.1 QUANTITATIVE PERFORMANCE OBJECTIVE: REDUCTION IN SOIL 1,4-DIOXANE

The primary purpose of the XSVE technology is to reduce the vadose zone source of 1,4-dioxane to groundwater such that groundwater remediation efforts can reach completion. Soil 1,4-dioxane concentrations are a measure of source strength of vadose zone 1,4-dioxane.

3.1.1 Data Requirements

The evaluation of this performance objective will be based upon soil 1,4-dioxane concentrations within the XSVE treatment zone prior to and after completion of XSVE operation. Composite soil samples will be obtained from 5 soil borings within the XSVE treatment area before and after XSVE operation. Composite soil samples will be obtained from the XSVE treatment area using incremental sampling methodology (ITRC, 2012).

3.1.2 Success Criteria

Success criteria for this performance objective is to achieve a greater than 90% reduction in the weighted average 1,4-dioxane soil concentration determined within the XSVE treatment zone pre- and post-XSVE operation. If at least 90% of the vadose zone 1,4-dioxane is removed, it can be reasonably assumed the remainder is in portions of the soil with less air flow. This remainder in the soil should have a substantially reduced flux to groundwater.

3.2 QUANTITATIVE PERFORMANCE OBJECTIVE: MINIMIZATION OF DOWNWARD MIGRATION OF 1,4-DIOXANE

The potential exists during XSVE for water condensation to occur within the treatment zone along the air flow path between the heated injection wells to the extraction well. This condensation should not adversely affect XSVE performance as long as the soil moisture content does not exceed residual saturation causing downward migration of vadose water containing 1,4-dioxane.

3.2.1 Data Requirements

The evaluation of this performance objective will be based upon soil 1,4-dioxane concentrations beneath the XSVE treatment zone prior to and after completion of XSVE operation. Composite soil samples will be obtained from the 5 soil borings at a depth below the treatment zone before and after XSVE operation.

3.2.2 Success Criteria

Success criteria for this performance objective is to achieve less than a 20% increase in the weighted average 1,4-dioxane soil concentration determined beneath the XSVE treatment zone pre- and post-XSVE operation.

3.3 QUALITATIVE PERFORMANCE OBJECTIVE: ADEQUATE SOIL GAS 1,4-DIOXANE MEASUREMENTS AT ELEVATED TEMPERATURES

Soil gas sampling of 1,4-dioxane under ambient temperature conditions is straightforward as condensation of water vapor does not occur within the sampling canister. XSVE will increase the temperature of the treatment zone, approaching 90°C in some areas. Sampling difficulties may occur when soil temperatures increase since condensation of water vapor will occur as temperature returns to ambient in the sampling canister. Condensation can serve as a sink for 1,4-dioxane, changing measured vapor phase concentrations. The vapor/condensate sampling method was used to estimate 1,4-dioxane concentrations.

This method condenses most of the soil moisture, collects the condensate which is analyzed for 1,4-dioxane and collects the resulting soil gas at ambient temperature for analysis. The total 1,4-dioxane mass sampled is calculated, which is used to calculate the effective soil gas 1,4-dioxane concentration using the volume of air extracted. The qualitative performance objective is for dependable vapor concentrations to be obtained at elevated temperatures.

Page Intentionally Left Blank

4.0 SITE DESCRIPTION

4.1 SITE SELECTION

BRAC (Base Realignment and Closure) Former McClellan AFB, CA was selected as the test site for this technology demonstration. The study site is within the Operable Unit (OU) D landfill near SVE well VES-105.

4.2 SITE LOCATION AND HISTORY

Former McClellan AFB, CA is approximately 7 miles northwest of Sacramento (see Figure 4.2.1 below). McClellan was an active industrial facility since 1939; used for the maintenance of bombers during World War II and the Korean conflict; and jet aircraft in the 1960s; and later maintenance and repair of electronics and communications equipment. Historical operations released contaminants into the soil and groundwater at McClellan. In 1995 the BRAC Commission recommended the base for closure; and in 2001 McClellan was closed as an active military base (Former McClellan AFB Air Force Real Property Agency, 2007).

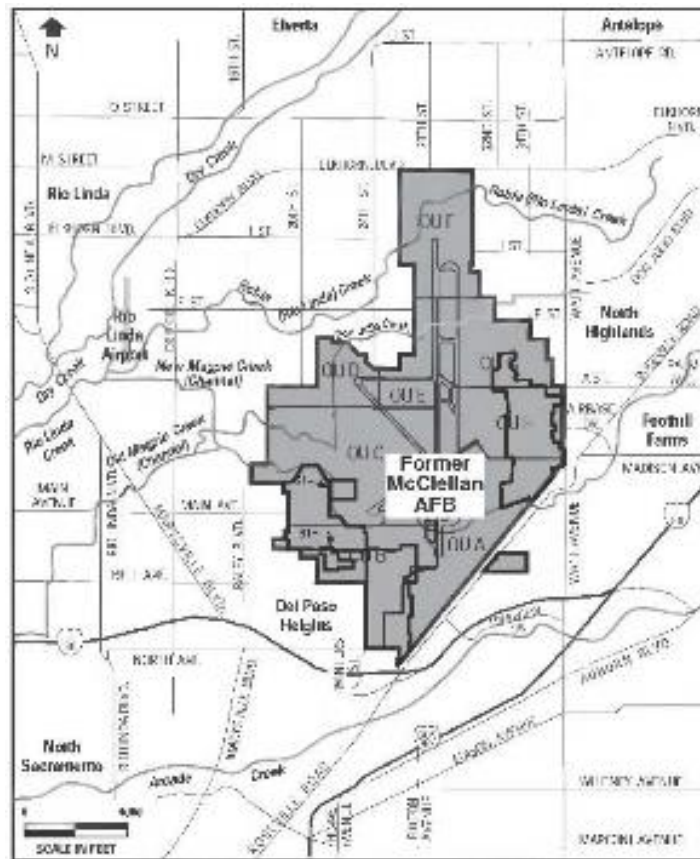

Figure 4.2.1. Former McClellan AFB, Located near Sacramento, CA (Former McClellan AFB Air Force Real Property Agency, 2007).

OU-D is located in the northwest part of installation.

The study site at McClellan is located within the Operable Unit (OU) D landfill in the northwest quadrant of the facility. Within OU-D were 11 former disposal pits. Chlorinated solvents (including TCA) are main COCs within OU-D. Groundwater extraction and SVE systems were installed. In 1995, a double-liner cap and drainage system was installed over the OU-D landfill (URS, 2013). The disposal pits were excavated prior to installation of the landfill cap. The OU-D SVE system has been operated consistently since 1996.

The climate at Former McClellan AFB is characterized by hot, dry summers and cool, moist winters. Average rainfall is about 19 inches per year, mostly from November to May. Annual evapotranspiration rate is approximately 45 inches, so the net precipitation for the area is -26 inches per year (Engineering-Science, 1983).

4.3 SITE GEOLOGY/HYDROGEOLOGY

The geology of the OU-D area is characterized by a complex series of alluvial and fluvial deposits that were deposited, eroded and redeposited. The subsurface geologic environment consists of transitional alluvial system alternating between braided streams and meandering streams/flood plains. This geologic environment has resulted in little lithologic continuity, making correlation between similar lithologies difficult (i.e., soil borings even short distances apart may demonstrate little lithologic continuity; CH2M Hill, 1992). These observations are consistent with the boring logs obtained during this project (see Appendix A). Water bearing sands are generally encountered close to 100 ft bgs. Groundwater flow direction varies, but is generally to the west in the vicinity of VES-105.

4.4 CONTAMINANT DISTRIBUTION

The 2004 distribution of VOCs in groundwater and soil gas at Former McClellan AFB are shown in Figure 4.4.1. SVE systems have been located in various portions of the facility, including OU-D. The OU-D SVE system operation is important in understanding the past and current VOC and current 1,4-dioxane distributions. The system consists of 31 SVE wells and 80 soil vapor monitoring wells (URS, 2014a). Only 5 to 10 SVE wells operate at any given time. Major expansions/upgrades of the SVE system occurred in 1996 and 2001.

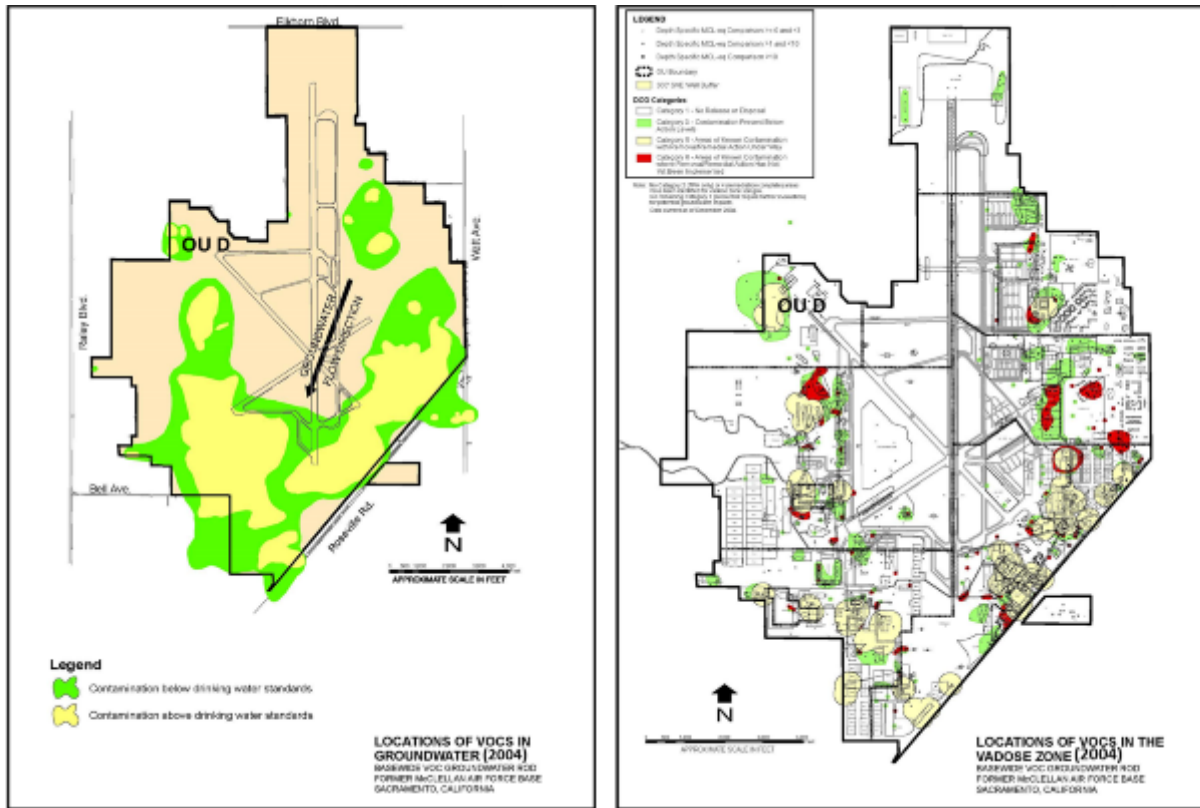

Figure 4.4.1. 2004 Facility-wide VOC Distributions in Groundwater (left) and Soil Vapor (right).

(Former McClellan AFB Air Force Real Property Agency, 2007). OU-D location indicated.

The OU-D SVE system cumulative mass removed for the primary VOCs encountered is shown in Figure 4.4.2. Routine collection of 1,4-dioxane concentrations began in 2013. OU-D SVE system mass removal rates for the primary VOCs including 1,4-dioxane are shown in Figure 4.4.3.

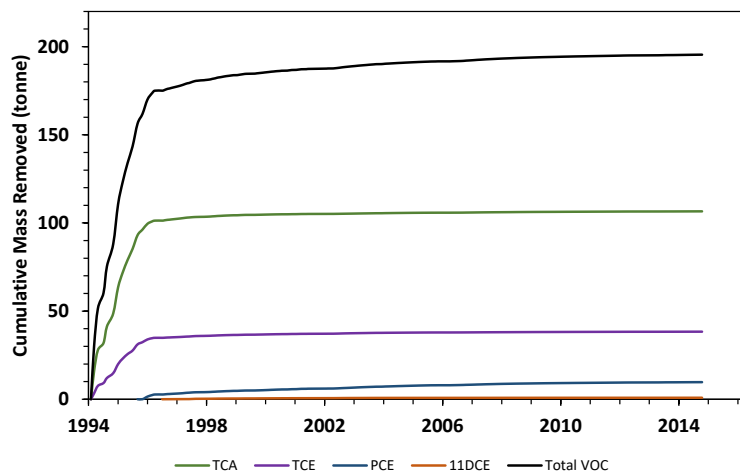

Figure 4.4.2. OU-D SVE System Cumulative Mass Removed for Primary VOCs.

Note: Data set is incomplete prior to 1996 for PCE and 11DCE.

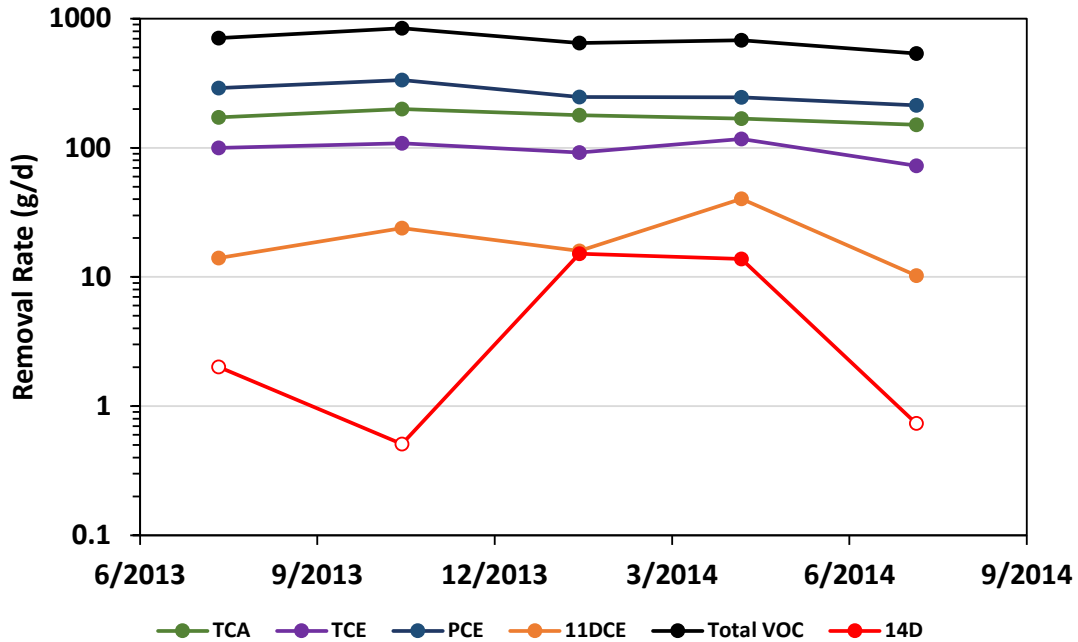

Figure 4.4.3. OU-D SVE System Mass Removal Rates for Primary VOCs Including 1,4-dioxane.

Open symbols are non-detects and are plotted as detection limits.

Figure 4.4.4 shows the OU-D soil gas VOC distributions in 1996 and 2013. OU-D VOC distribution is localized in two areas (northern and southern) and concentrations have decreased significantly. OU-D northern area is the focus of this project. In recent years, SVE in the northern area has primarily been from wells VES-105 (screened 40 – 100 ft bgs) and VES-106 (screened 40 – 100 ft bgs). In 2013, VEP-110A (screened 28 – 30 ft bgs) was converted to an extraction well and added to the SVE system. The highest VOC concentrations in the northern area were most recently from VEP-110A. It is our understanding that the SVE system was turned off some time after completion of this demonstration. SVE off-gas treatment was by oxidizer only (GAC was used in addition to the oxidizer prior to 2013).

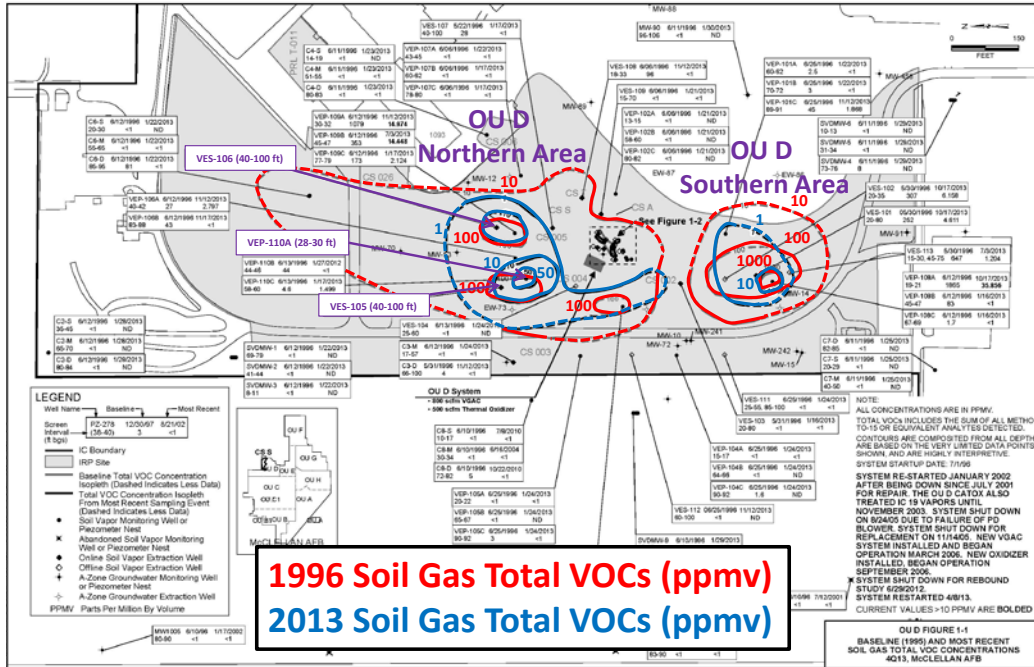

Figure 4.4.4. Baseline (1996) and Current (2013) OU-D Soil Gas Total VOCs (Note: north to left) (URS, 2014a).

SVE wells VES-105 and VES-106 were located in the 2 northern area VOC ‘hot spots’ in the 1996 baseline soil gas total VOC distribution and both have been in nearly continuous operation since then. The locations of the 1996 baseline ‘hot spots’ were approximate due to low sampling resolution. TCA was likely discharged into the VES-105 area since the highest 1,4-dioxane concentration (700 ppb_v) was observed there. After discharge of the TCA-containing solvent, 1,4-dioxane appears to have partitioned into vadose zone water. The solvent was likely more widely distributed than 1,4-dioxane. Although 97 ppb_v 1,4-dioxane was observed in nearby VEP-109B (screened 45-47 ft) it was not observed in SVE well VES-106 (screened 40-100 ft).

VES-105 is screened over a wide interval from 40 to 100 ft bgs (screened to near the water table) and is likely drawing soil gas from most of that screened interval. However, it is unlikely that 1,4-dioxane is evenly distributed throughout that interval, so the resulting composite 700 ppb_v 1,4-dioxane concentration is likely the dilution of higher 1,4-dioxane soil gas levels (confirmed by PneuLog results presented below). VEP-110A (screened 28-30 ft) and VEP-110B (screened 44-46 ft) located ~70 feet to the south VES-105 showed no detections for 1,4-dioxane, even though the highest total VOC levels were in VEP-110A. This suggests that the dominant vadose zone source of 1,4-dioxane is in the VES-105 vicinity and does not extend to VEP-110 approximately 70 feet away.

The historical disposal areas are shown in Figure 4.4.5 along with the original SVE well locations. VES-105 and VES-106 are located within the pits “Site 4” and “Site 5”, respectively. VEP-110 is located between those two disposal areas. 1,4-Dioxane soil gas concentrations observed in 2013 are shown Figure 4.4.6. The highest 1,4-dioxane soil gas concentrations were observed in VES-105 (700 ppb_v) which is in pit “Site 4”, indicating that this pit likely the dominant 1,4-dioxane source area.

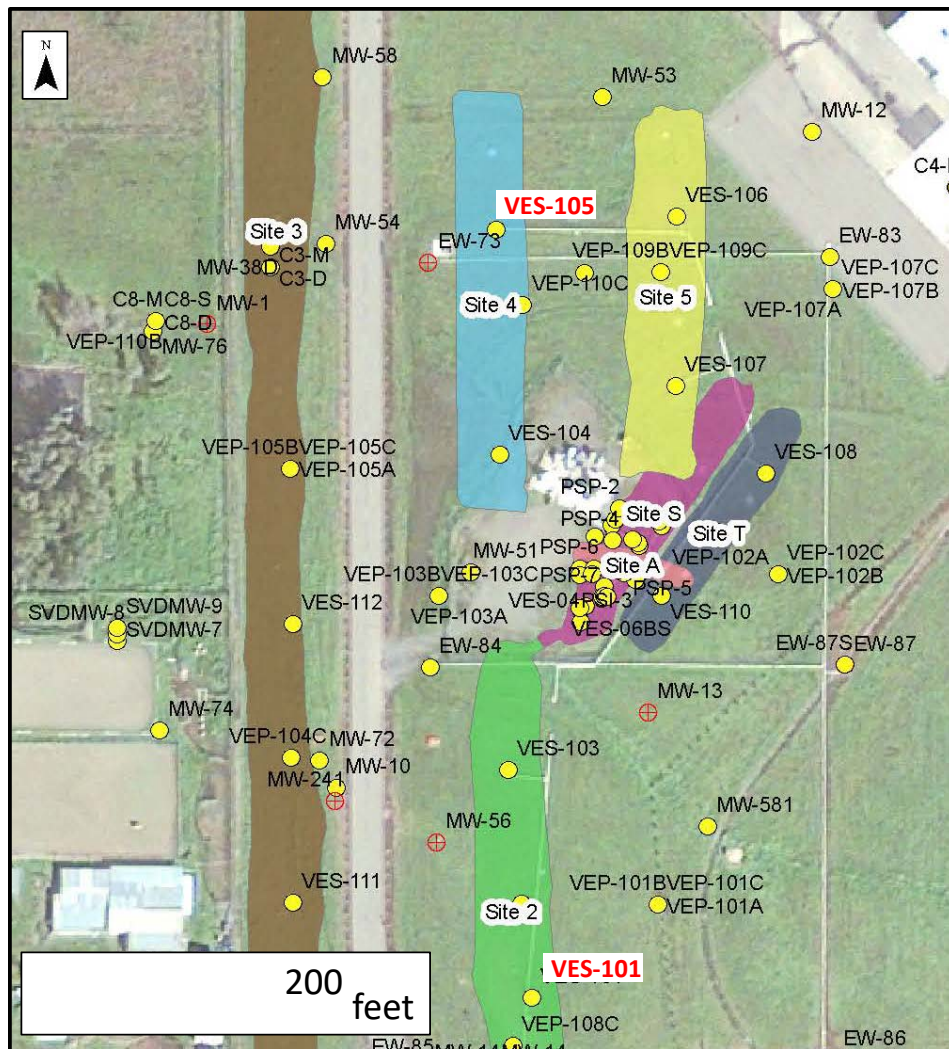

Figure 4.4.5. Overlay of Historical Disposal Trenches within OU-D Northern Area with SVE System and Soil Gas Monitoring Network Showing the Locations of VES-105 and VES-101 (Ken Smarkel, Noblis Inc., Former McClellan AFB).

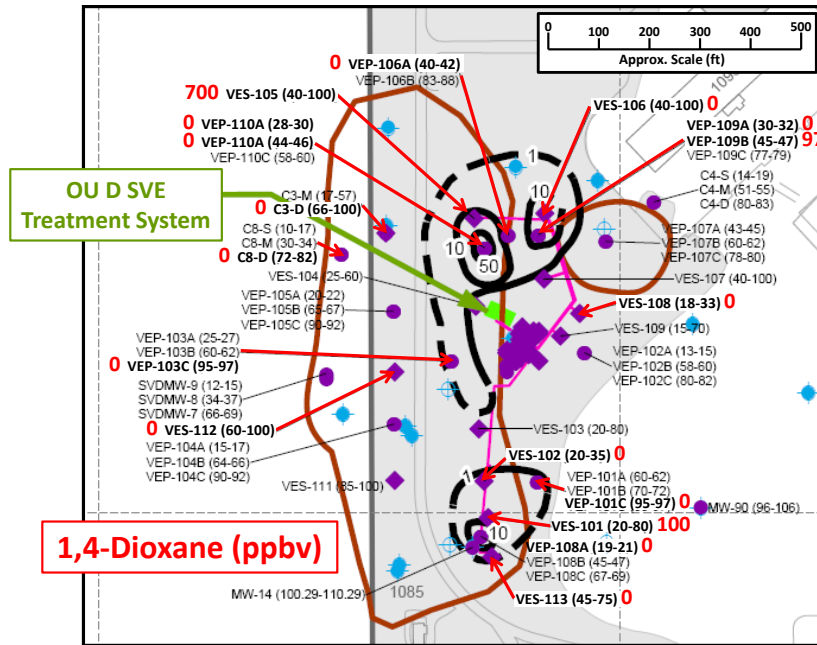

Figure 4.4.6. OU-D 1,4-dioxane Soil Gas Concentrations Observed in 2013 prior to this Demonstration Project (data obtained from Ken Smarkel, Noblis Inc., Former McClellan AFB).

Base map black isopleths are soil vapor total VOCs (ppm_v) and brown isopleth is groundwater VOC MCL (URS, 2014a).

OU-D Northern Area 4th Quarter 2013 SVE operating conditions and VOC concentrations are shown in Tables 4.4.1 and 4.4.2 below. VES-105 is the only OU-D Northern Area SVE well with 1,4-dioxane. Tetrachloroethylene (PCE) is the predominant VOC.

Table 4.4.1. 4Q2013 OU-D SVE Operation (URS, 2014a).

Well	VOC Mass Removal (pounds/day)	Air Flow (scfm)
VES-105	0.44	72
VES-106	0.72	82
VEP-110A	0.56	43
Northern Area Total (3 wells)	1.72	197
OU-D Total (6 wells)	3.29	546

Table 4.4.2. 4Q2013 Select Chlorinated VOC Concentrations for OU-D Northern Area SVE Wells (AECOM Database, 2016).

Compound	VES-105 (ppm _v)	VES-106 (ppm _v)	VEP-110A (ppm _v)
PCE	7.6	4.1	16
TCE	0.91	3.4	2.1
1,1,1-TCA	0.83	5.3	1.4
1,1-DCA	0.30	3.3	0.58
1,1-DCE	0.39	0.87	0.06
c-1,2-DCE	0.16	0.32	0.35
1,4-Dioxane	0.69	ND (<0.003)	ND (<0.007)

Shallow zone groundwater 1,4-dioxane concentrations in the OU-D area for 2013 are shown below in Figure 4.4.7. The 1,4-dioxane groundwater plume configuration is consistent with the vicinity of VES-105 being a vadose zone source area for 1,4-dioxane in groundwater (groundwater flow generally to the west).

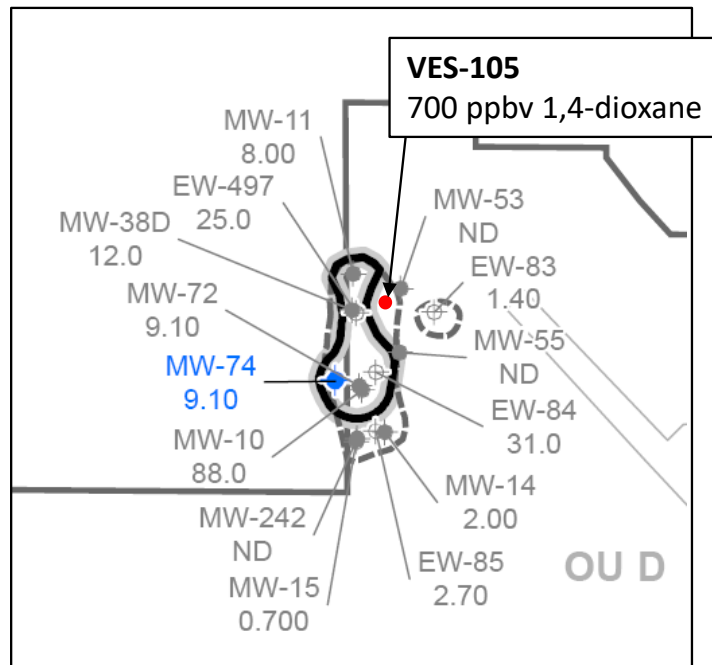

Figure 4.4.7. 2013 OU-D Shallow Groundwater Zone 1,4-dioxane Concentrations (µg/L; URS, 2014b; VES-105 location added).

To gain a better understanding of contaminant distribution and air permeability in VES-105 and VES-101, PneuLog[®] profiling was performed (Praxis Environmental Technologies, Inc., Burlingame, CA). SVE well VES-101 in the southern part of OU-D was included to be evaluated as a potential study site since it showed 1,4-dioxane, albeit at considerably lower concentrations than VES-105. PneuLog[®] profiling had been done in a number of SVE well locations at the former McClellan AFB with results useful to implementation of SVE systems.

PneuLog[®] well logging is performed by simultaneously measuring the cumulative air flow and chemical vapor concentrations along the depth of an extraction well screened interval during active SVE. To make these measurements, a flow sensor is moved through the well during vapor extraction and soil gas samples are collected continuously and analyzed. Figure 4.4.8 shows a schematic of the PneuLog[®] profiling operation and a photograph of the field equipment.

The PneuLog[®] instrumentation is attached to a cable, which passes through alignment pulleys and a vacuum-tight fitting at the wellhead. The instrumentation is raised or lowered by a motorized reel around which the cable is wound. The logging proceeds at roughly eight feet per minute along the screen in the SVE well. Sensors in the pulley assembly indicate the depth of the measurement. Electrical leads connect the flow sensor to a data acquisition system located on the motorized reel. A vapor sampling tube connects the sample port on the instrument to a vacuum pump, also on the reel. The sampling pump draws a continuous stream of air through the sampling tube to the surface where it is analyzed for compounds of interest. A photoionization detector (PID) is used to provide a continuous reading of total VOC concentration. Tedlar bag vapor samples were collected and analyzed off-site with a gas chromatograph. Summa canister samples were collected for off-site TO-15 analyses to determine compound-specific concentrations at discrete depths; and used to verify the Tedlar bag/GC-determined concentrations.

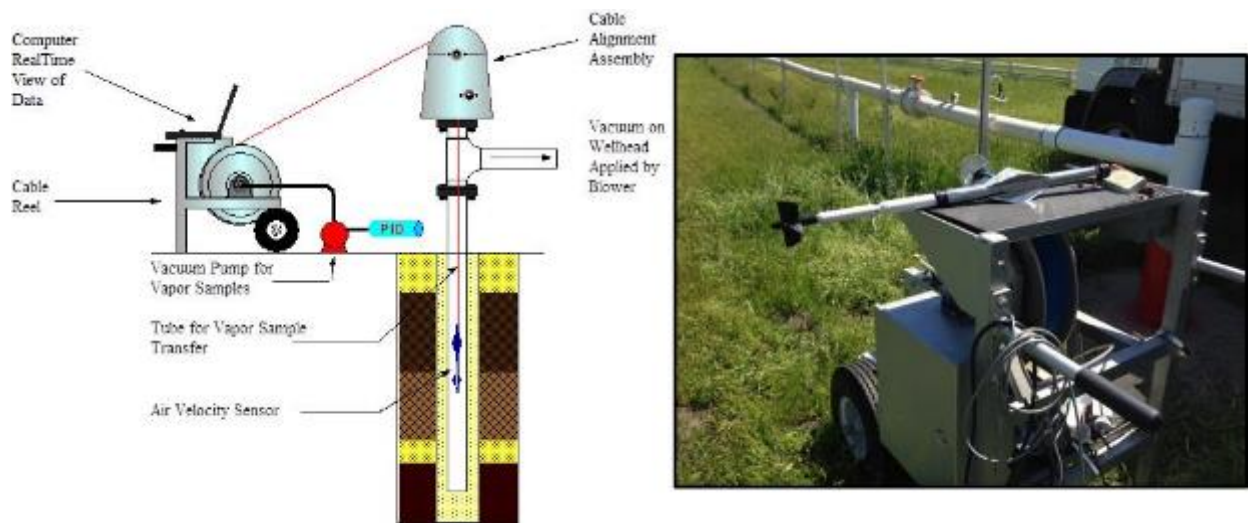

Figure 4.4.8. Schematic of PneuLog[®] Profiling Operation (Praxis Environmental Technologies, Inc.) and Photograph of Field Equipment.

An effective air permeability profile can be generated using the soil gas production profile with multi-dimensional analytical or numerical airflow models. The permeability of an interval is proportional to the change in flow across the interval, its thickness, its depth below the surface and the well vacuum according to Darcy's law. The effective air permeability profiles for VES-105 and VES-101 are shown below in Figures 4.4.9 and 4.4.10. VES-105 has a series of thin zones of higher permeability and can be characterized as moderately permeable to permeable throughout the area where 1,4-dioxane is observed. Similar effective permeability results were obtained for VES-101.

Estimated soil gas concentrations for 1,4-dioxane and TCA are also shown in Figures 4.4.9 and 4.4.10 for VES-105 and VES-101. The 1,4-dioxane concentration profiles and cumulative concentration (at top of profile) were in agreement with the recent cumulative (under SVE operation) concentrations: 700 ppb_v (2013) vs. 815 ppb_v (PneuLog) for VES-105; and 100 ppb_v (2013) vs. 51 ppb_v (PneuLog) for VES-101.

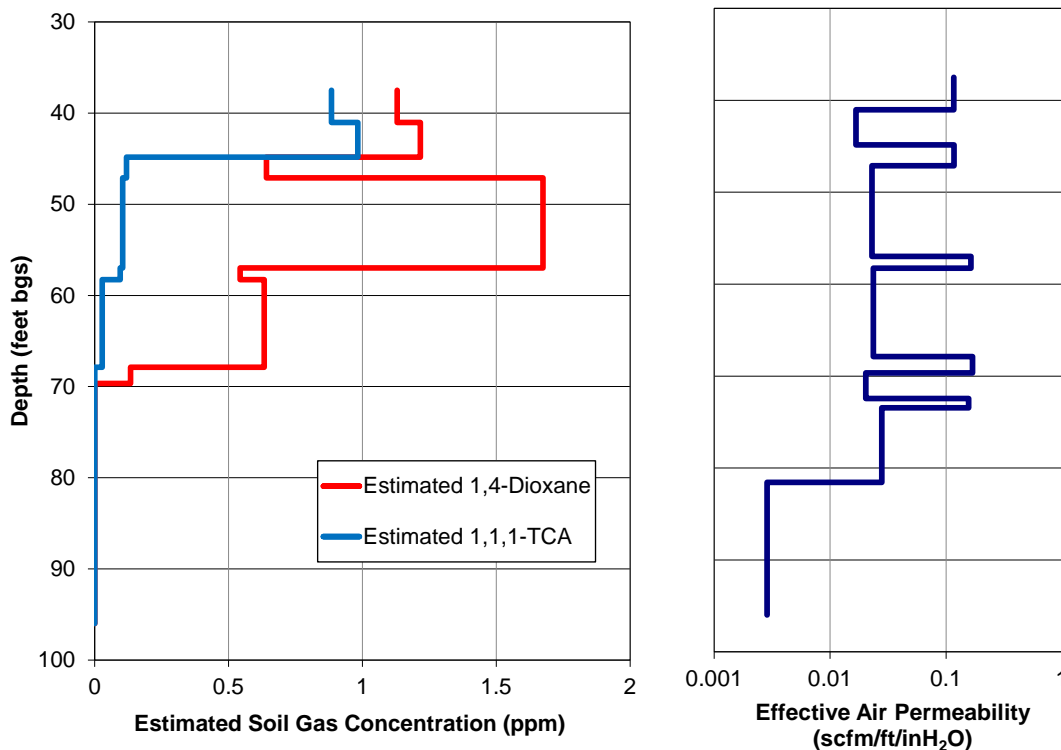

Figure 4.4.9. VES-105 PneuLog[®] Profiling Results Showing Estimated Soil Gas Concentrations (ppm_v) for 1,4-dioxane and TCA; and Effective Air Permeability (scfm/ft/inH₂O).

TCA results are included since TCA is the likely 1,4-dioxane source. For both wells, TCA soil gas concentrations are higher in the upper portions (shallower depths) of the profiles. Continuing down in depth, TCA decreases to low levels while 1,4-dioxane increases in a zone beneath the peak TCA levels. Results indicate that although TCA concentrations were historically high where the 1,4-dioxane concentrations were presently high, TCA has been largely removed by long-term SVE operation. The results indicate that 1,4-dioxane persisted in the vadose zone water. This pattern is consistent with personal observations made in other sites.

The VES-105 profiling results appear to indicate that the higher effective air permeability lenses influenced the NAPL distribution. The 68 to 70 ft bgs lens appears to have formed the lower base of the NAPL distribution. The 57 to 58 ft bgs lens appears to have reduced the downward migration of NAPL. The 45 to 47 ft bgs lens appears to have allowed for pooling and lateral distribution of NAPL with higher concentrations resulting beneath it. The estimated 1,4-dioxane soil gas concentrations are lower within this 45 to 47 ft lens, which may indicate that the higher air flow rate within this zone has removed much of the 1,4-dioxane.

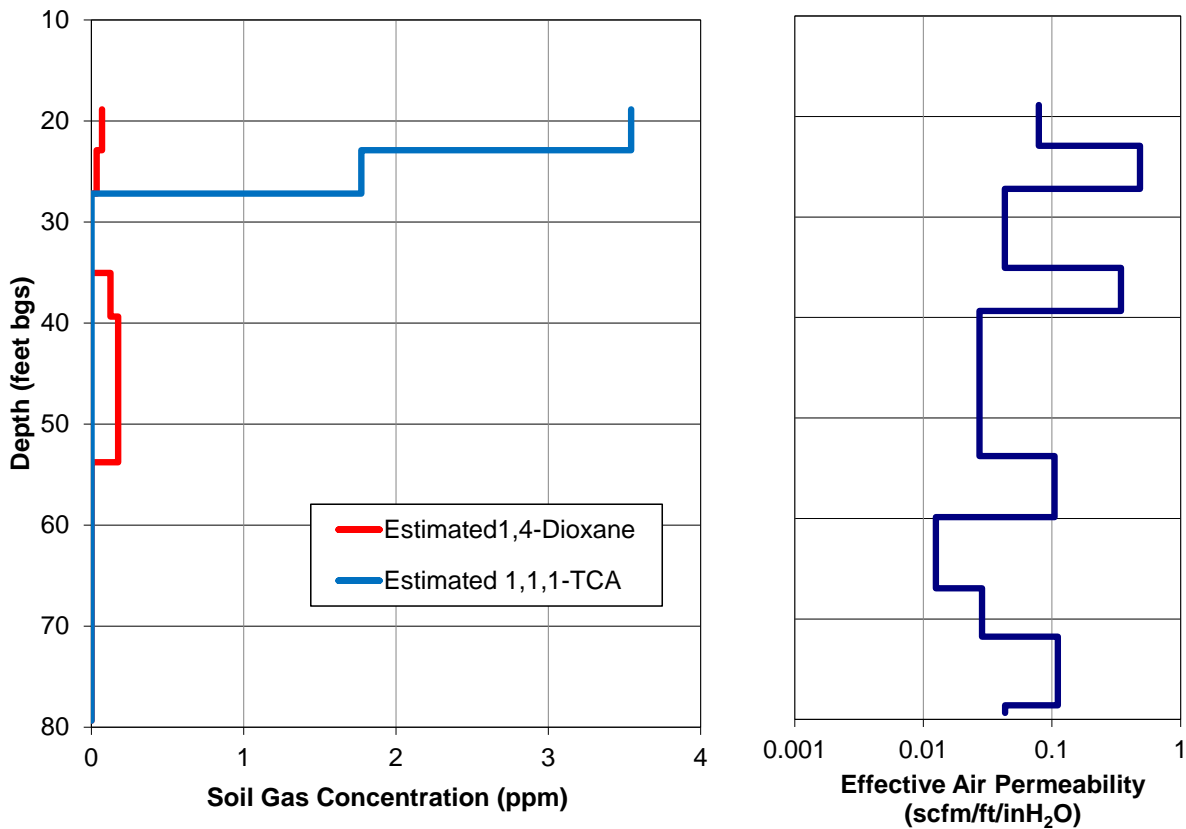

Figure 4.4.10. VES-101 PneuLog[®] Profiling Results Showing Estimated Soil Gas Concentrations (ppm_v) for 1,4-dioxane and TCA; and Effective Air Permeability (scfm/ft/inH₂O).

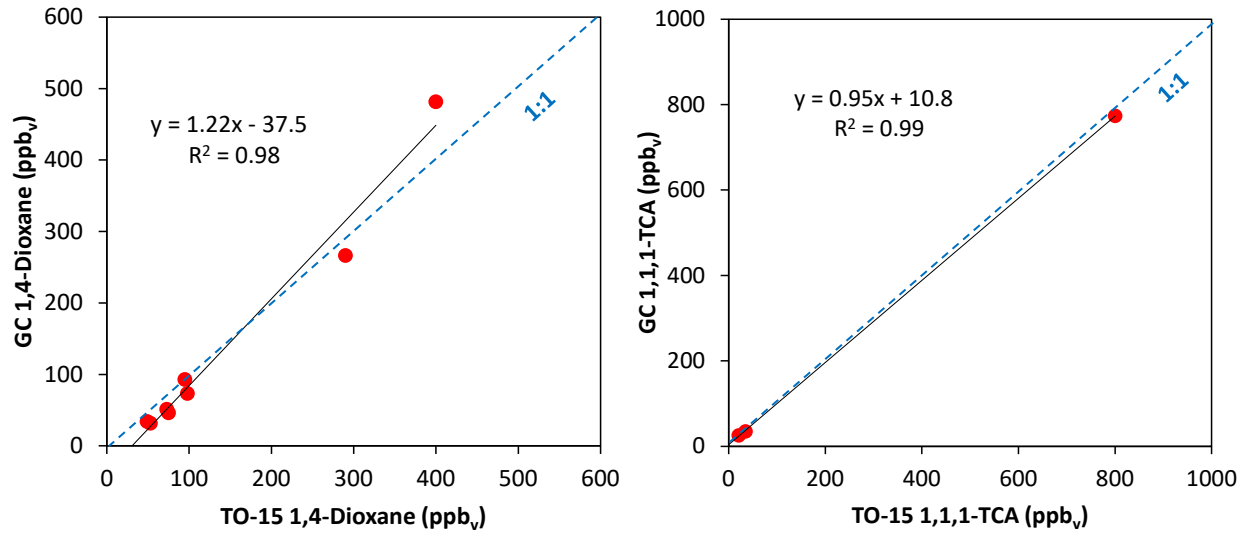

Figure 4.4.11. Correlation Analysis between GC (Tedlar bags) and TO-15 (Summa canisters) for 1,4-dioxane and TCA.

The PneuLog profiles in Figures 4.4.9 and 4.4.10 are based on the Tedlar bag GC results. The comparison between the Tedlar bag GC results with the Summa canister TO-15 results are shown in Figure 4.4.11 above. The results are in good agreement and show that the data used for the PneuLog profiles are sufficiently accurate.

The results indicated that VES-105 would be the preferable study site location for this project. The 1,4-dioxane soil gas concentrations are substantially higher in VES-105. The 1,4-dioxane concentrations and distribution indicate that it is within a significant vadose source area for 1,4-dioxane. Examination of the VES-105 PneuLog profiling data show that an XSVE well screened ~38 to ~68 ft bgs could remove > 90% of the 1,4-dioxane mass in a study area in that vicinity. VES-105 is located within a known waste disposal trench with chlorinated solvents, including TCA. The cumulative masses removed for the primary VOCs from VES-105 are shown in Figure 4.4.12. 1,4-Dioxane concentrations were routinely collected from VES-105 starting in 2013. The VES-105 mass removal rates for the primary VOCs including 1,4-dioxane are shown in Figure 4.4.13.

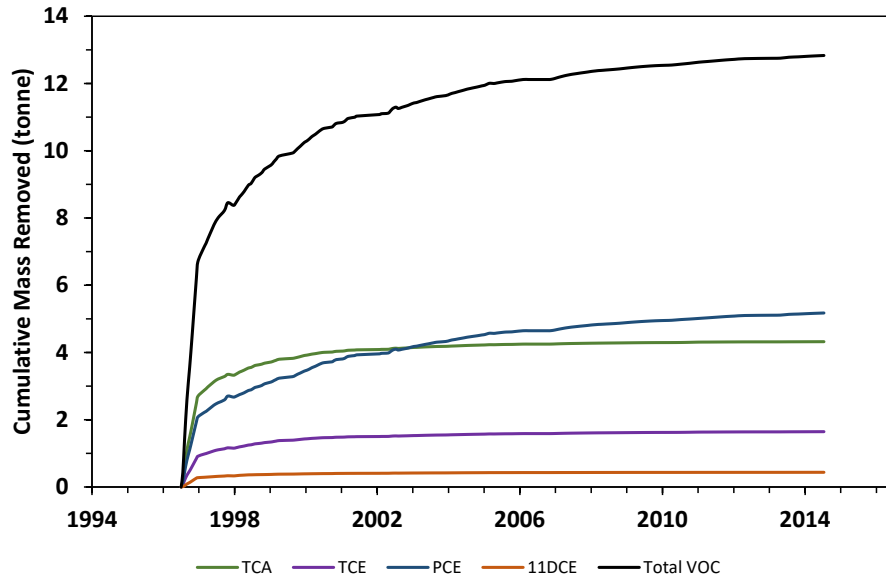

Figure 4.4.12. VES-105 Cumulative Mass Removed for Primary VOCs.

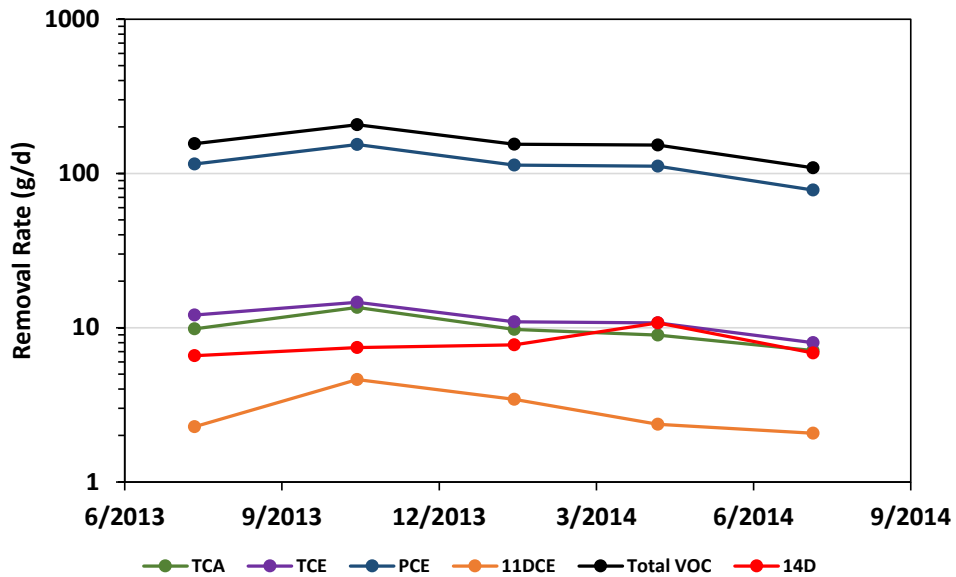

Figure 4.4.13. VES-105 Mass Removal Rates for Primary VOCs and 1,4-dioxane.

Page Intentionally Left Blank

5.0 TEST DESIGN

5.1 CONCEPTUAL EXPERIMENTAL DESIGN

Field observations at various sites has shown that although some 1,4-dioxane removal occurs during conventional SVE, cleanup is incomplete. This is also the case at the Former McClellan AFB as shown in the PneuLog profiling for VES-105 and the 1,4-dioxane groundwater plume. XSVE addresses this problem through a combination of increased air flow, increased temperature, decreased infiltration, and focused air extraction. The site was already capped so infiltration was already severely limited. The PneuLog profile indicate that the majority of 1,4-dioxane is within the 38 to 68 ft bgs zone at VES-105. The demonstration injection and extraction wells would be screened approximately 38 to 68 ft bgs to focus air extraction and increase extraction flow rates in the region 1,4-dioxane was observed. Injection air would be heated to at least 90°C to increase the temperature of the treatment zone.

VES-105 well construction and materials were not compatible with focused flow and elevated temperatures needed for XSVE. Therefore, the demonstration site was in close proximity to VES-105. VES-105 is situated in the historic Site 4 trench (see Figure 4.4.5) which is long and narrow with a width of about 75 ft. Shifting the demonstration area slightly to the north within the trench was believed to have conditions similar to VES-105. To insure that the demonstration area had a substantial vadose zone source of 1,4-dioxane, soil 1,4-dioxane concentrations would be determined in the field during well installation.

Wicking of soil moisture from the area surround the treatment zone was expected to have a minimal effect on XSVE operation (wicking adds moisture to extracted soil vapor and prolongs the time to dry out the treatment zone). To help to minimize potential wicking, the upper and lower extent of the screened interval will be placed in higher permeability zones. There were higher effective air permeability zones at around 38 ft and 68 ft to minimize wicking from above and below.

The general layout of the XSVE system is shown in Figure 5.1.1. The four injection wells formed a 20 ft square pattern around a central vapor extraction well. Preliminary screening-level modeling (discussed below) indicated a combined injection flow rate up to approximately 400 scfm (100 scfm per injection well) and the extraction flow rate approximately 100 scfm should be satisfactory. Based on geometry is assumed that a fourth of the injected air flows into the target treatment zone and ultimately to the extraction well. This was necessary since AECOM continued to operate the OU-D SVE system around the XSVE demonstration site.

Four locations within the treatment area 20 ft X 20 ft footprint were instrumented to assess conditions within and below the treatment zone (approximate locations shown in Figure 5.1.1). At each of these locations were vapor monitoring probes (within treatment zone only), temperature and soil moisture sensors. These four locations are referred to as VMW locations.

Injection flow was distributed equally between the four wells. A vapor treatment system of sufficient capacity for this project was present at the site and the XSVE extracted air was blended with the existing SVE system air for treatment. The injection air was to be heated by in-line heaters at each wellhead.

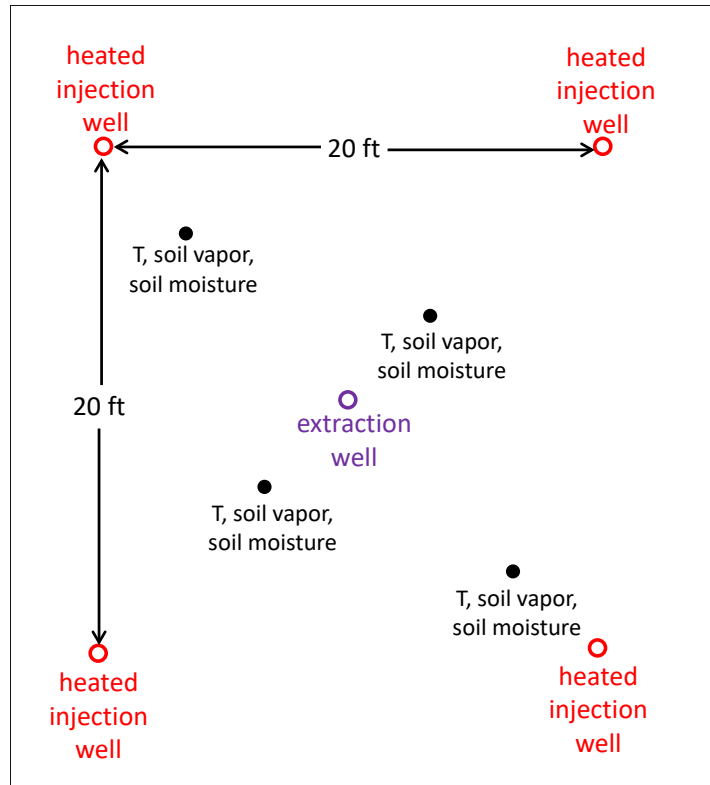

Figure 5.1.1. Plan View Schematic of Conceptual XSVE Demonstration Layout.

The soil borings used to install the four monitoring locations along with the extraction well soil boring were used to collect samples to determine initial 1,4-dioxane soil concentration and soil moisture content (Figure 5.1.1). Comparable soil borings (Figure 5.5.2) were used to collect samples to determine the final 1,4-dioxane soil concentration at the completion of XSVE. Also shown in Figure 5.5.2 are the sampling zones incremental sampling methodology (ITRC, 2012). These sampling zones are referred to as the Outer Ring, Inner Ring and Center.

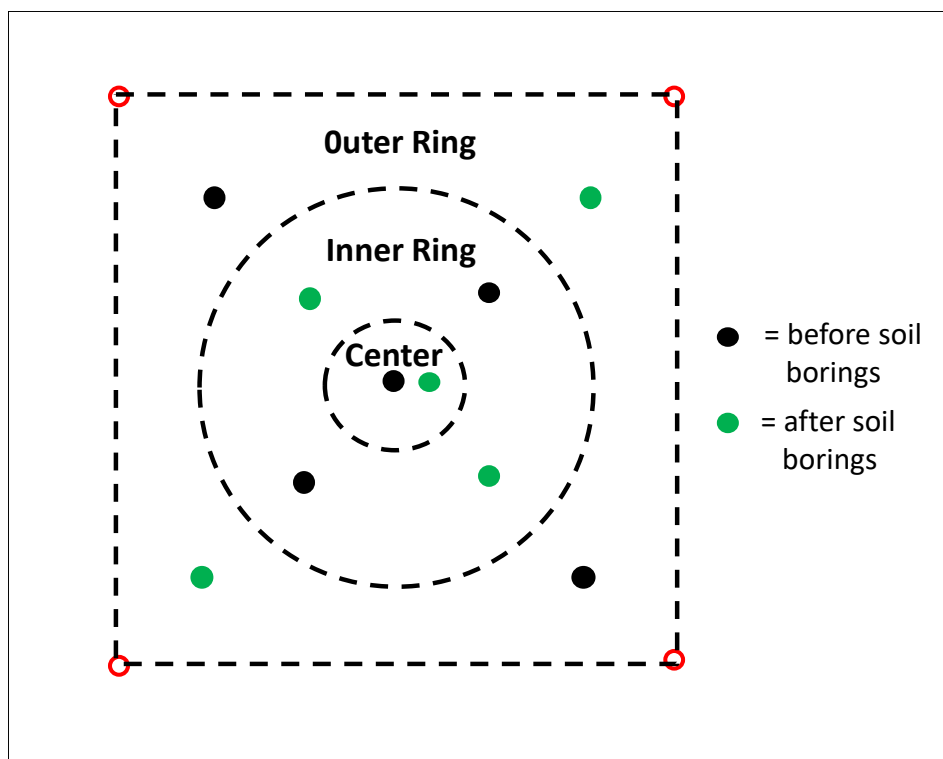

Figure 5.1.2. Plan View Conceptual Schematic of Soil Borings to Be Taken before and after XSVE Demonstration showing the Three Zones Used for Incremental Sampling (outer ring, inner ring and center).

XSVE process monitoring included periodic sampling of the multi-level samplers for 1,4-dioxane in soil gas, in situ soil moisture content and temperature. The extraction well effluent were periodically to be sampled for 1,4-dioxane soil gas concentrations.

This conceptual design was based on a combination of bench-scale laboratory and simple screening-level model results. First, lab tests were conducted to experimentally determine the Henry's Law constant for 1,4-dioxane and to look for dependencies on moisture content and 1,4-dioxane concentration (which will both decrease during XSVE treatment). The partitioning tests were conducted by filling VOA vials with 30 g of a dried silty sand soil, and then injecting an aqueous 1,4-dioxane solution to create a spectrum of conditions, including moisture contents of 1.3, 5, 10, 15, 20, and 25 %, and 1,4-dioxane concentrations of 4.6, 46, 460, 4,600 mg/kg-soil. After mixing by shaking and about 24-h of equilibration, headspace samples were collected and analyzed by GC-FID. Henry's Law Constants were calculated by assuming all of the 1,4-dioxane was dissolved in the soil moisture and using the relationship $H_i = C_{\text{vapor}}/C_{\text{dissolved}}$. Results are presented below in Figure 5.1.3.

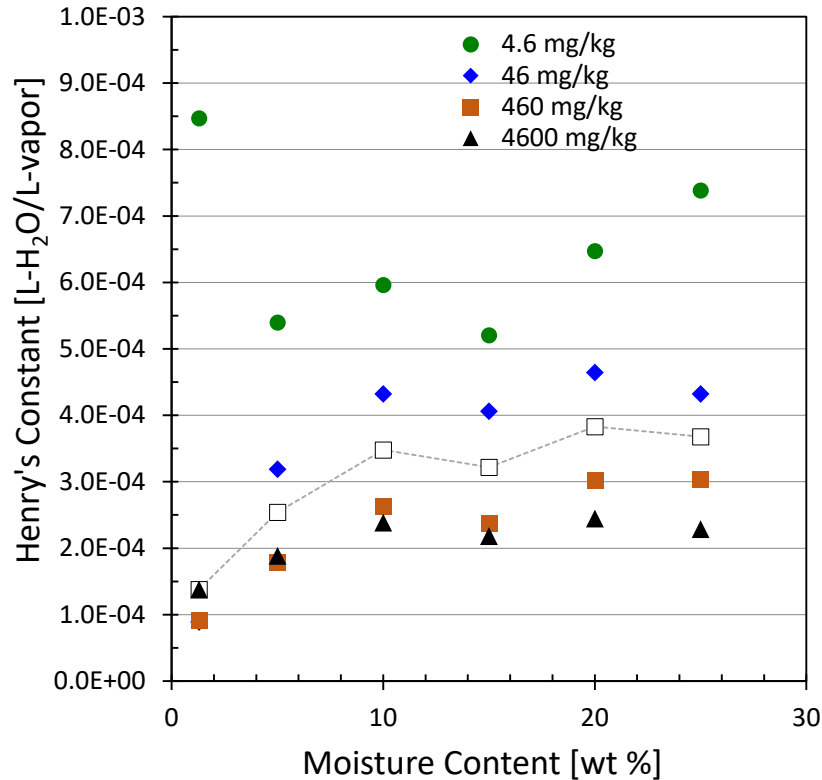

Figure 5.1.3. Experimentally Determined Henry's Law Constants (H_i) for 1,4-dioxane in Soil under Varying Conditions of Soil Moisture and 1,4-dioxane Concentration.

Medians for H_i values (open squares) at each moisture content are also displayed.

The results suggest that H_i increase with decreasing 1,4-dioxane concentration; the increase is by a factor of 2X to 3X for a concentration decrease of 1000X. The results also suggest some decreasing dependence of H_i on soil moisture. The median of all values is about 3×10^{-4} L-H₂O/L-vapor, which compares well with values of about 2×10^{-4} L-H₂O/L-vapor by Ondo and Dohnal, 2007.

A preliminary screening-level spreadsheet model (XHypeVent; See Section 5.8 for final screening-level model) was created for this project to examine ideal XSVE performance for 1,4-dioxane removal under a range of operating conditions. It is similar to the HyperVentilate SVE-screening model (Johnson and Stabenau, 1993) formerly distributed by USEPA in that it assumes well-mixed conditions and local equilibrium partitioning. It extends that approach by incorporating a heat balance and a water mass balance, and temperature dependencies of water and 1,4-dioxane partitioning, all of which are important aspects of XSVE performance. Sample results were generated for a set of conditions likely to be representative of OU-D, as summarized below:

- Treatment volume = 6.1 m x 6.1 m x 10 m = 372 m³
- Initial moisture content = 0.05 g-H₂O/g-soil (i.e., 5%)

- Total porosity = 0.40 m³-pores/m³-soil
- Initial 1,4-dioxane soil concentration = 1.5 mg/kg-soil
- Initial soil temperature = 18°C
- Average ambient temperature = 25°C
- Average ambient relative humidity = 40%

Based on these conditions, the initial 1,4-dioxane soil vapor concentration is calculated to be 1500 ppb_v, which is consistent with the VES-105 PneuLog[®] profiling results. The corresponding initial 1,4-dioxane leachate concentration is estimated to be 30 mg/L-H₂O. The 3 x 10⁻⁴ L-H₂O/L-vapor median H_i value discussed above was used in these calculations.

The projected ideal performance is presented below in Figure 5.1.4 for XSVE. Key performance results are also summarized in Table 5.1.1 relative to pore volumes of air flow under ideal conditions. For reference, for the conceptual design conditions (100 scfm through a 20 ft x 20 ft x 30 ft air flow treatment zone), one-year of operation equates to about 10,000 pore volumes. Field conditions were not expected to exhibit ideal conditions due to heterogeneities and higher initial field soil moisture content (not known at time of screening-level modeling).

Table 5.1.1. Preliminary Screening-Level Model Output Considered in the Test Design

Operating Conditions	Pore Volumes Estimated to Achieve Performance Metrics Listed Below Under Ideal Conditions		
	90% Mass Reduction	99% Mass Reduction	10 µg/L in leachate
XSVE with 90°C air injection temperature	1200	2000	3000

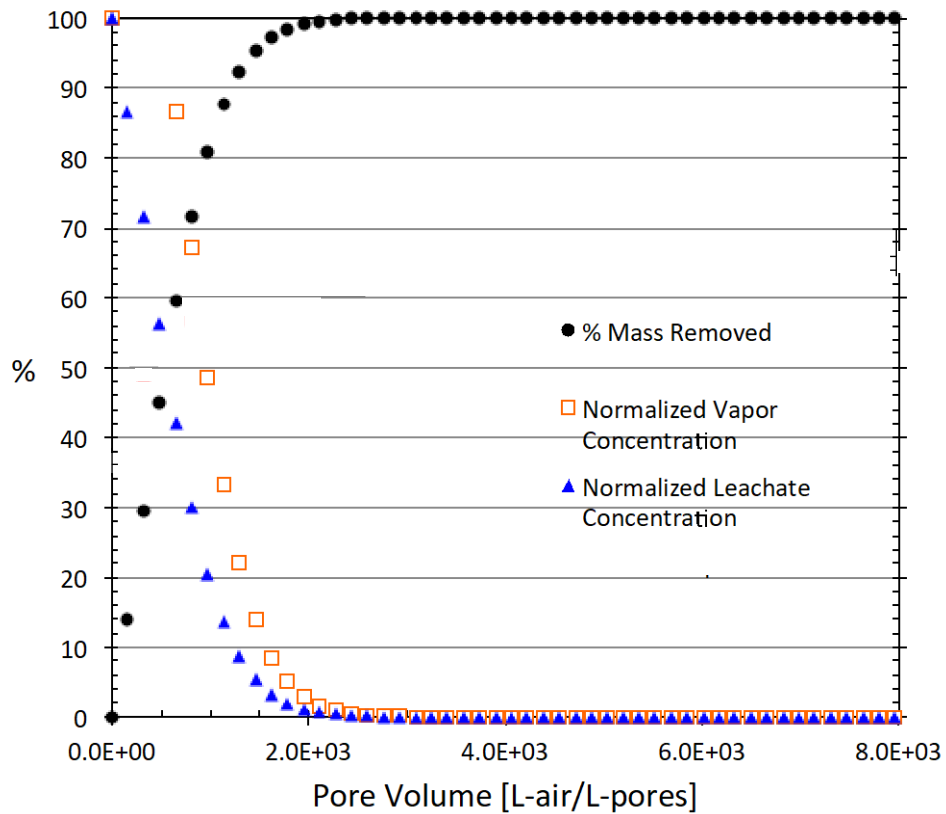

Figure 5.1.4. Preliminary Screening-level Model Projected Ideal Performance under XSVE Conditions at 90°C Injection Temperature.

Preliminary lab-column testing was conducted to study characteristics of 1,4-dioxane removal and to complement screening-level modeling. The two column tests utilized 60 g of silty sand with 100 mg/kg of 1,4-dioxane soil concentrations in moist (0.15 g-H₂O/g-soil; i.e., 15% soil moisture) and dry (<0.005 g-H₂O/g-soil; i.e., < 0.5% soil moisture) conditions. A vapor flowrate of approximately 150 mL/min was utilized. Figure 5.1.5 shows the extracted vapor concentrations vs. estimated pore volumes for the initial column tests under ambient conditions. The column conditions (0.5 and 15% soil moisture) bracket the XHypeVent screening model condition of 5% soil moisture. The preliminary model results are consistent with the preliminary column experiment results for ambient SVE conditions.

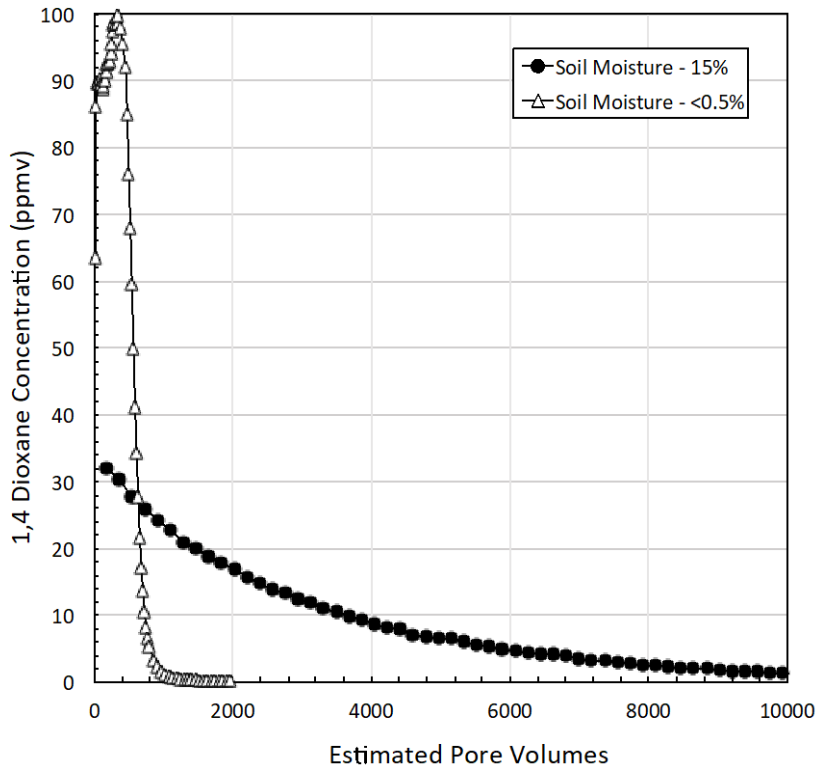

Figure 5.1.5. Preliminary Bench-scale (column) Venting Test Run Results under Ambient Conditions.

5.2 BASELINE CHARACTERIZATION ACTIVITIES

Baseline site characterization was conducted during site instrumentation activities (installation of injection and extraction wells and VMW locations). Drilling and well installation on the former McClellan AFB, CA XSVE demonstration site was conducted in September 2014. All investigation-derived wastes (IDW) were containerized and disposed in the facility landfill. The site layout is shown in Figure 5.2.1. To prevent VES-105 from being a conduit for vapor flow it was grouted. As soil borings were advanced, soil samples were characterized using the Unified Soil Classification System (USCS) to generate boring logs (Appendix A). A geologic cross section of the XSVE treatment zone is shown in Figure 5.2.2 (Note: Cross-section includes logs of confirmation soil borings taken after XSVE operation.). The XSVE treatment zone is characterized primarily as silty sand and sandy silt, with some sand and silt layers.

Prior to drilling it was not known whether the site layout would contain a treatment zone with sufficient 1,4-dioxane for the demonstration project. Field analysis of 1,4-dioxane soil concentrations was conducted to confirm the presence of 1,4-dioxane contamination. The site layout could have been adjusted if needed during drilling, however adjustment was not necessary. Field analysis of 1,4-dioxane was conducted by Triad Environmental Solutions, Inc. (Durham, NC). Soil samples were extracted with water and solid phase micro extraction (SPME) was used extract 1,4-dioxane from the water. The SPME fiber was thermally desorbed into direct sampling ion trap mass spectrometer for quantification. The results of the field analysis are shown in Figure 5.2.3.

The field analysis results showed that the mg/kg levels of 1,4-dioxane were present in the treatment zone, thus the site layout configuration was suitable. It should be noted that this field analysis method was not directly comparable to laboratory analysis, however it was sufficiently adequate for the purposes of confirming a suitable site layout was obtained during drilling activities. Laboratory determined 1,4-dioxane concentrations and water content for composite samples from the soil borings are given in Figures 5.2.4 and 5.2.5, respectively.

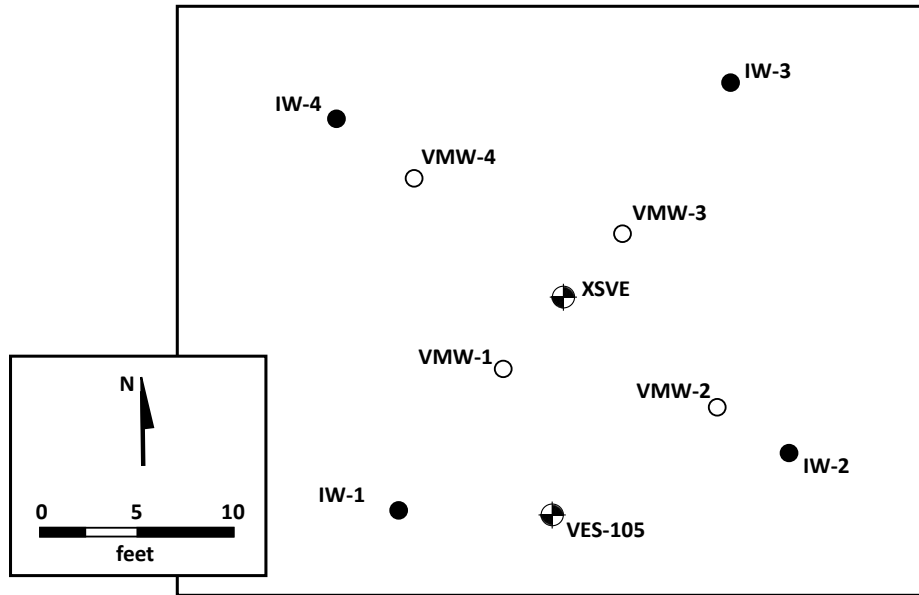

Figure 5.2.1. Extraction, Injection and Vapor Monitor Well Locations Relative to VES-105.

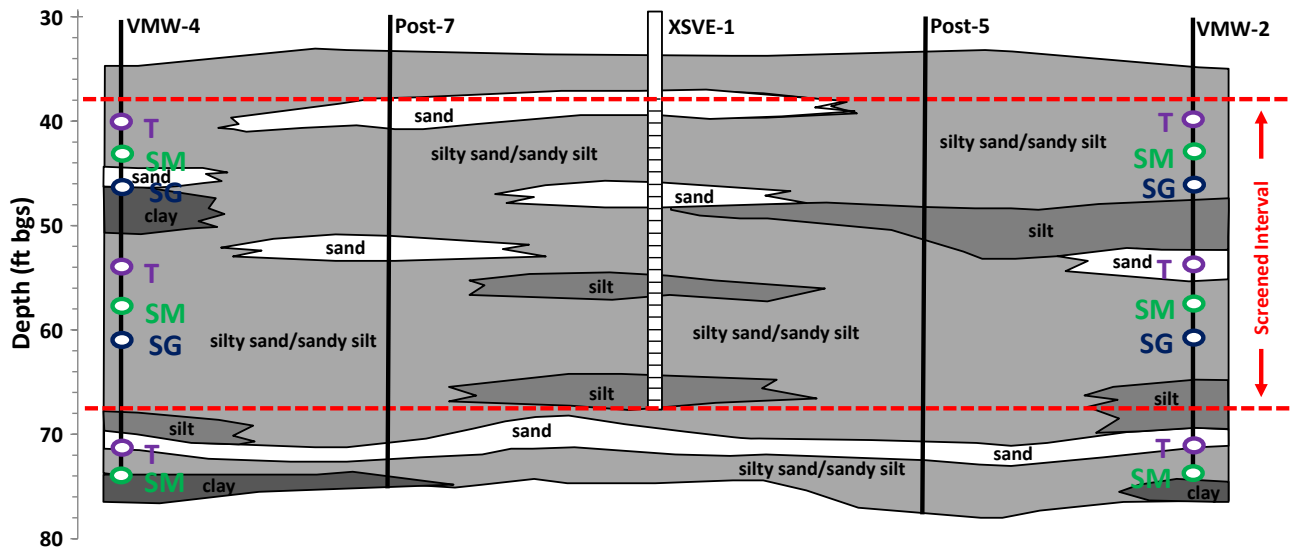

Figure 5.2.2. Geologic Cross-section for VMW-4 to VMW-2 Transect.

(SG – soil gas probe; T – temperature sensor; SM – soil moisture sensor)

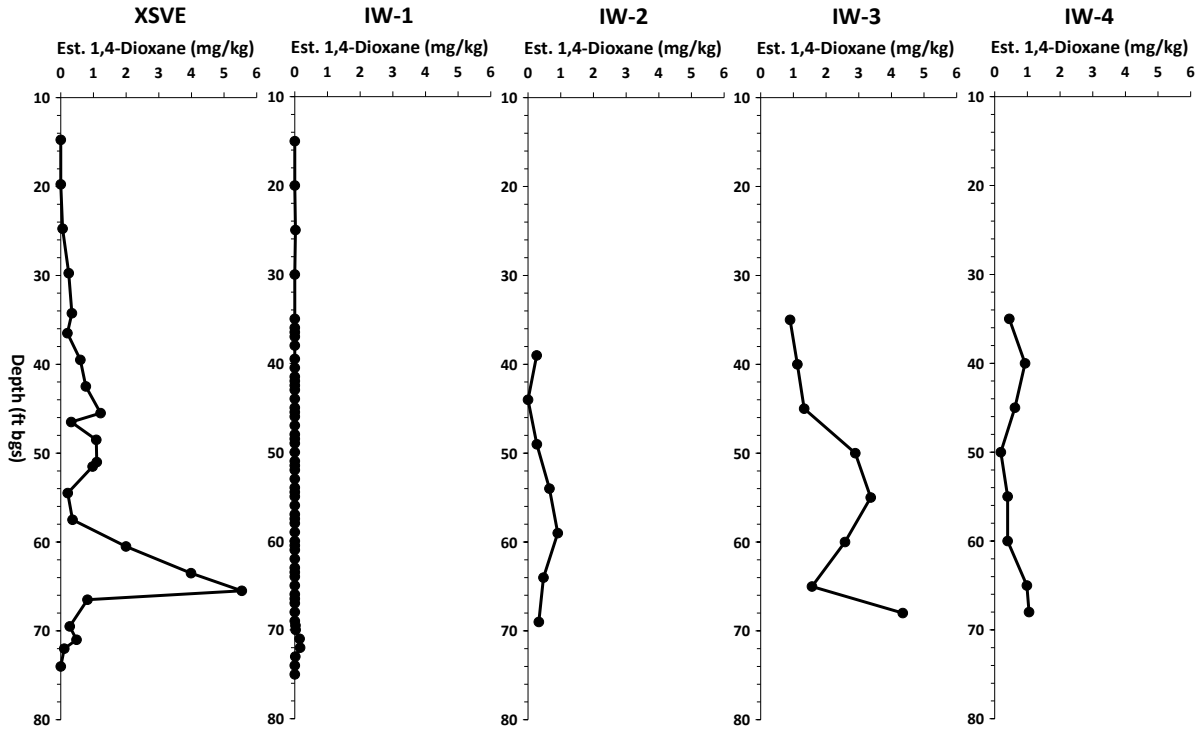

Figure 5.2.3. Estimated 1,4-dioxane Soil Concentrations (mg/kg) Based on On-site Field Analysis by Triad Environmental Solutions, Inc..

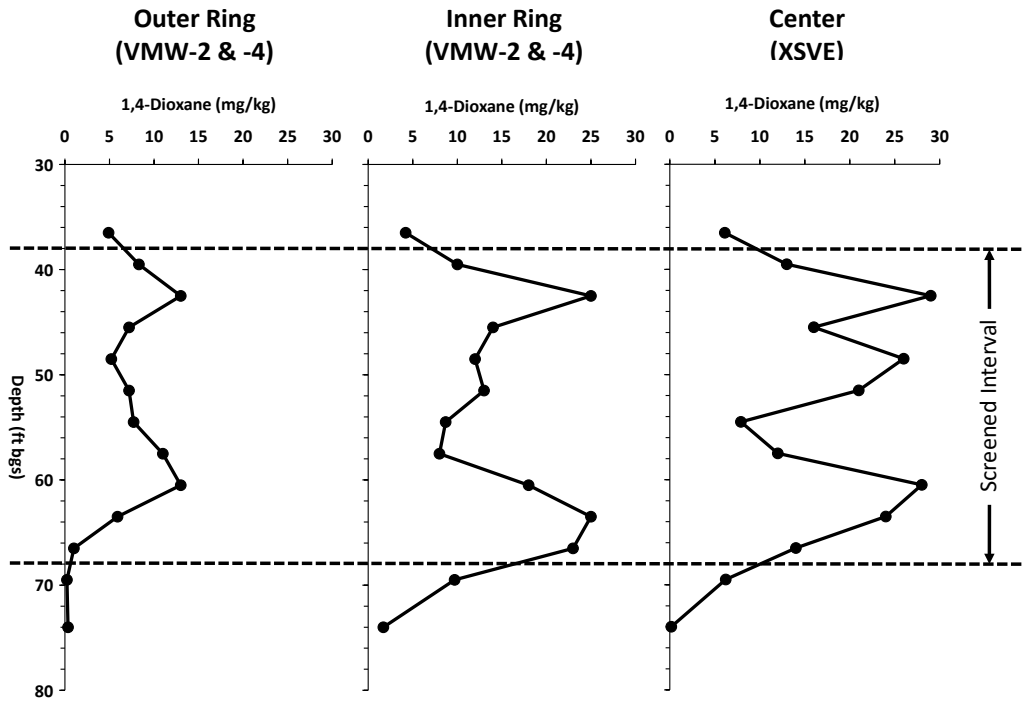

Figure 5.2.4. 1,4-Dioxane Soil Concentrations (mg/kg) prior to XSVE Operation.

Depths are the centers of the 3-foot composite intervals.

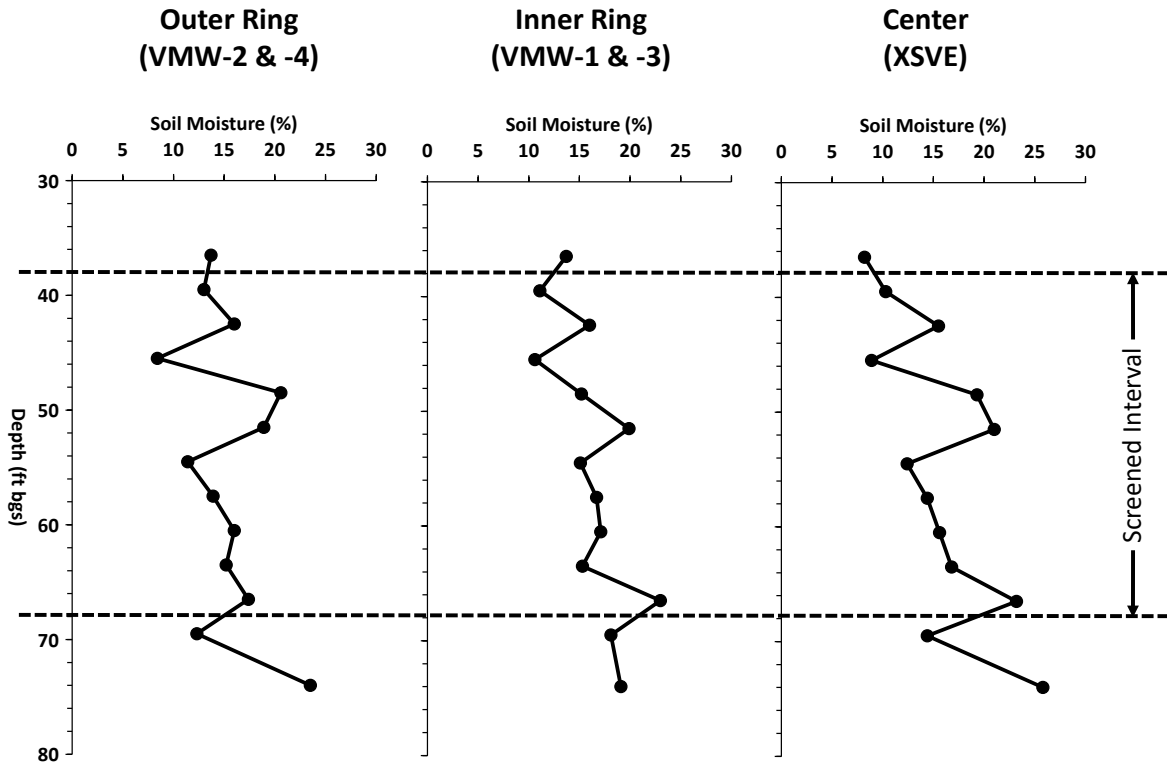

Figure 5.2.5. Soil Moisture Concentrations (%) prior to XSVE Operation.

Depths are the centers of the 3-foot composite intervals.

5.3 LABORATORY STUDY RESULTS

5.3.1 1,4-Dioxane Soil Vapor Sampling at Elevated Temperatures

When sampling soil vapor at elevated temperatures using an evacuated vapor sampling canister (e.g., Summa canister), condensation of water vapor occurs within the canister which is at ambient temperature. 1,4-Dioxane could partition into that condensate and lower the measured vapor concentration. Laboratory experiments were conducted to evaluate whether this phenomena could potentially be a problem in field sampling of 1,4-dioxane at elevated temperatures using an alternative sampling method to account for potential losses due to condensation.

An alternative sampling method was devised for sampling soil vapor at elevated temperatures using what is called the vapor/condensate sampling apparatus. Figure 5.3.1 shows a schematic of the vapor/condensate sampling apparatus (Note: This is the configuration used in the field demonstration. Laboratory configuration was functional identical). The figure shows the sample flows in the purge, condensate collection and vapor sampling modes. The air flow is established by a vacuum pump (Gast vacuum/pressure diaphragm pump, single head, 1 cfm) and regulated by a mass flow controller (Alicat Scientific Model MC-2SLMP-D for flows up to 2 SLPM and Model MC-10SLPM-D/5V for flows up to 10 SLPM; the latter was used in the field).

The purge mode is used for field sampling to purge the lines prior to sampling, this mode was not required for laboratory testing. Purge flow rate was the maximum flow the tubing, connections and pump allowed. During the condensate collection mode, water vapor is condensed in an ice bath coil and collected in a 40 mL VOA vial (connected to condensation coil with rubber stopper). Flow through the condensation coil was normally in the 7 to 8 SLPM range (flow controlled by mass flow controller). The vapor sampling mode the air flow is diverted to an evacuated vapor sampling canister by a three-way valve. Purging still occurs during the condensate collection and vapor sampling modes, this was done to minimize potential condensation prior to the condensation coils. 1,4-Dioxane mass of in the condensate is calculated using the 1,4-dioxane concentration within the water condensate (determined by EPA Method 8270, ALS Environmental, Kelso, WA) and the volume of condensate (determined gravimetrically).

$$M^{cond} = Conc^{cond}Vol^{cond} \quad \text{Eq. 1}$$

, where M^{cond} is the 1,4-dioxane mass in the condensate, $Conc^{cond}$ is the 1,4-dioxane concentration in the condensate and Vol^{cond} is the volume of condensate. 1,4-Dioxane mass in the vapor is calculated using the 1,4-dioxane concentration in the vapor (determined by EPA Method TO-15; ALS Environmental, Simi Valley, CA) and the volume of vapor (determined by the flow rate established by the mass flow controller and the time used to collect the condensate sample).

$$M^{vap} = Conc^{vap}Vol^{vap} \quad \text{Eq. 2}$$

, where M^{vap} is the 1,4-dioxane mass in the vapor (after the ice bath cold trap), $Conc^{vap}$ is the 1,4-dioxane concentration in the vapor and Vol^{vap} is the volume of vapor sampled to obtain the condensate sample. The effective 1,4-dioxane vapor concentration (i.e., soil vapor concentration) is calculated using the combined 1,4-dioxane mass (vapor and condensate) and the volume of vapor used to collect the condensate.

$$Conc^{eff\ vap} = (M^{cond} + M^{vap}) \div Vol^{vap} \quad \text{Eq. 3}$$

, where $Conc^{eff\ vap}$ is the effective vapor concentration.

A photograph of the vapor sampling apparatus as used in the field is shown in Figure 5.3.2. A second ice bath condensation coil shown; second condensation coil was briefly used to confirm that there was no condensate breakthrough past the first coil. The ice bath condensate coils were placed within perforated PVC piping to allow for ease of emplacement and retrieval. Also shown is a mockup of an ice bath condensate coil with rubber stopper and VOA vial condensate collection vessel.

Results of laboratory experiments are presented in Table 5.3.1. 1,4-Dioxane mass in the condensate and vapor phases are shown in Figure 5.3.3. The results indicated that substantial 1,4-dioxane resides in condensate when high humidity vapor is sampled at elevated temperatures (i.e., conditions expected during XSVE demonstration). 1,4-Dioxane Henry's Constants calculated from this data are shown in Figure 5.3.4 and are comparable to those obtained by Ondo and Dohnal, 2007.

The vapor/condensate sampling apparatus was used as the sampling methodology for this demonstration to alleviate possible concerns about potential low sampling/analytical bias. Comparison of the vapor/condensate sampling apparatus results with those of the simpler, more conventional canister sampling was made during the XSVE field demonstration (see Section 5.7.1).

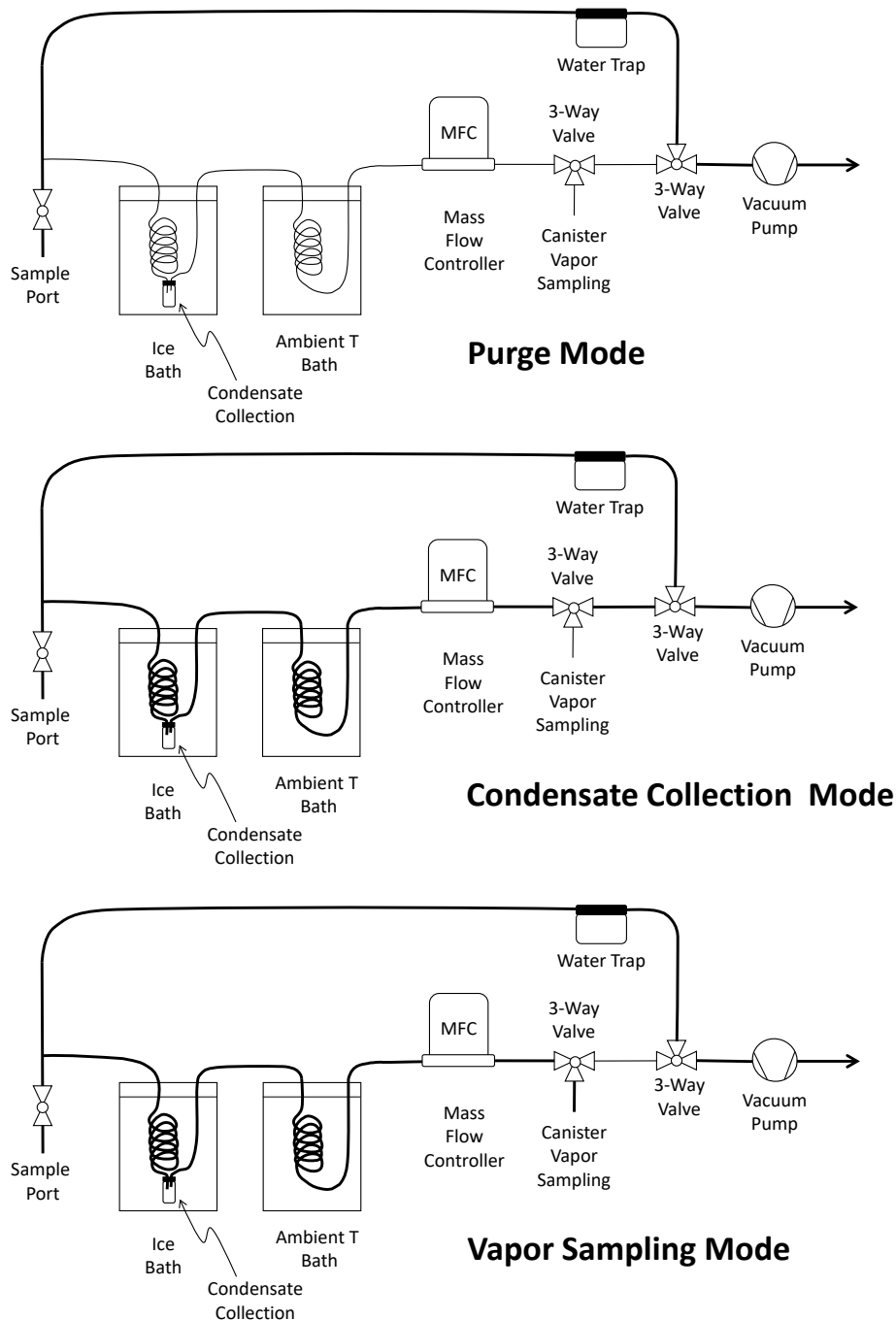

Figure 5.3.1. Schematic of Vapor/condensate Sampling Apparatus showing Purge, Condensate Collection and Vapor Sampling Modes.

Thicker tubing lines are open to air flow in the various modes.

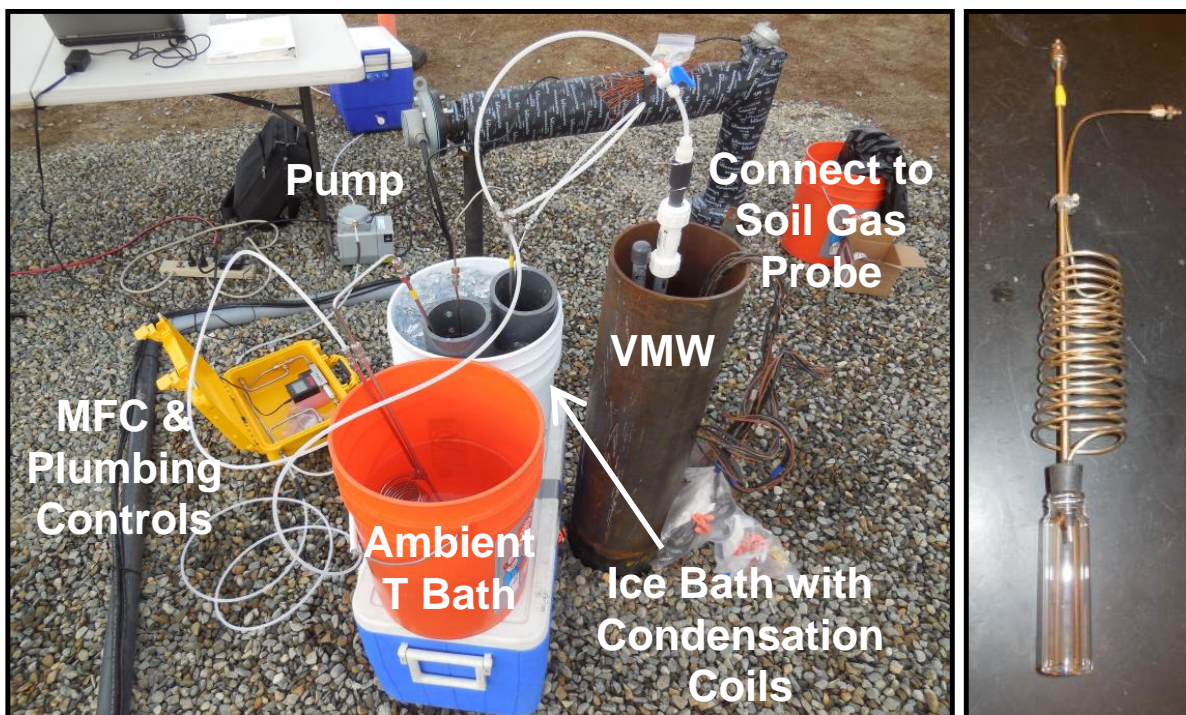

Figure 5.3.2. Vapor/Condensate Sampling Apparatus as Used in the Field (left). Ice Bath Condensate Coil Mockup with Stopper and VOA Condensate Collection Vessel Is Shown on Right

(Note that the tubing within VOA is normally near the stopper at the top.)

Table 5.3.1. Results of Vapor Generator (~2 L 18.5 mg/L 1,4-dioxane Sparged at Specified Temperature) Sampled Using Vapor/Condensate Sampling Apparatus.

Temperature (°C)	Sampling Time (min)	Vapor Flow Rate (L/min)	Condensate Volume (mL)	Vapor 1,4-Dioxane Concentration (mg/m ³)	Condensate 1,4-Dioxane Concentration (mg/L)
30	130	1.0	2.90	3.2	73
50	65	1.0	4.81	6.4	120
50	60	1.0	4.67	5.6	110
70	55	1.0	16.0	6.3	120
70	65	1.0	18.7	6.2	110

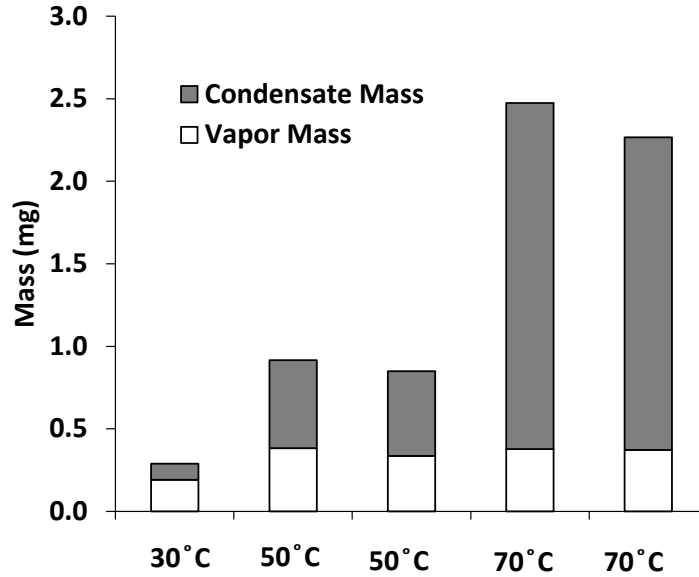

Figure 5.3.3. 1,4-Dioxane Mass for Condensate and Vapor Phases per Hour in Vapor Generator (18.5 mg/L 1,4-dioxane Sparged at Specified Temperature) Sampled Using Vapor/Condensate Sampling Apparatus at 1.0 L/min.

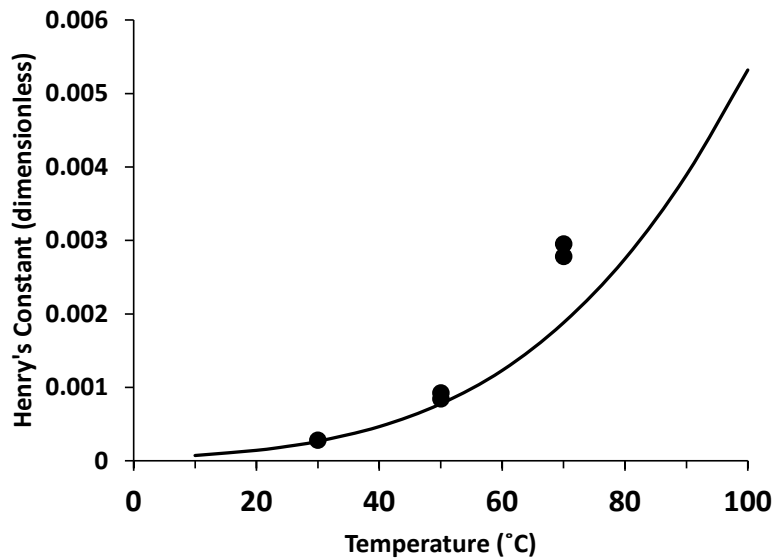

Figure 5.3.4. 1,4-Dioxane Henry's Constants Obtained at Different Temperatures for this Project (closed circles) Compared with those of Ondo and Dohnal, 2007 (solid line).

5.4 DESIGN AND LAYOUT OF TECHNOLOGY COMPONENTS

The XSVE treatment zone consists of one extraction well surrounded by four injection wells, all screened in the 38 to 68 ft bgs interval. Well construction and layout are shown in Figures 5.4.1 and 5.4.2. Thermocouples (Omega, thermocouple model 5TC-TT-K-20) are placed within the top of the extraction and injection well casings. Additionally, thermocouples are at the centers of the well screens within the injection well casings (within sand pack mid-screen would work as well). These are to monitor the temperature of the injected and extracted air.

There are 4 location (designated VMW) for monitoring conditions within the treatment zone. Each VMW contains two soil vapor monitoring probes (schedule 40 CPVC, 0.02-inch slots), in the upper and lower portions of the treatment zone. Each VMW also contains three set of temperature and soil moisture sensors (Soil Moisture Equipment Corporation, Minitrace Kit, 6050X3K5B, with 20 cm buriable coated waveguides), in the upper and lower treatment zone and below the treatment zone. Figure 5.4.3 shows the VMW sensor/probe instrumentation and installation.

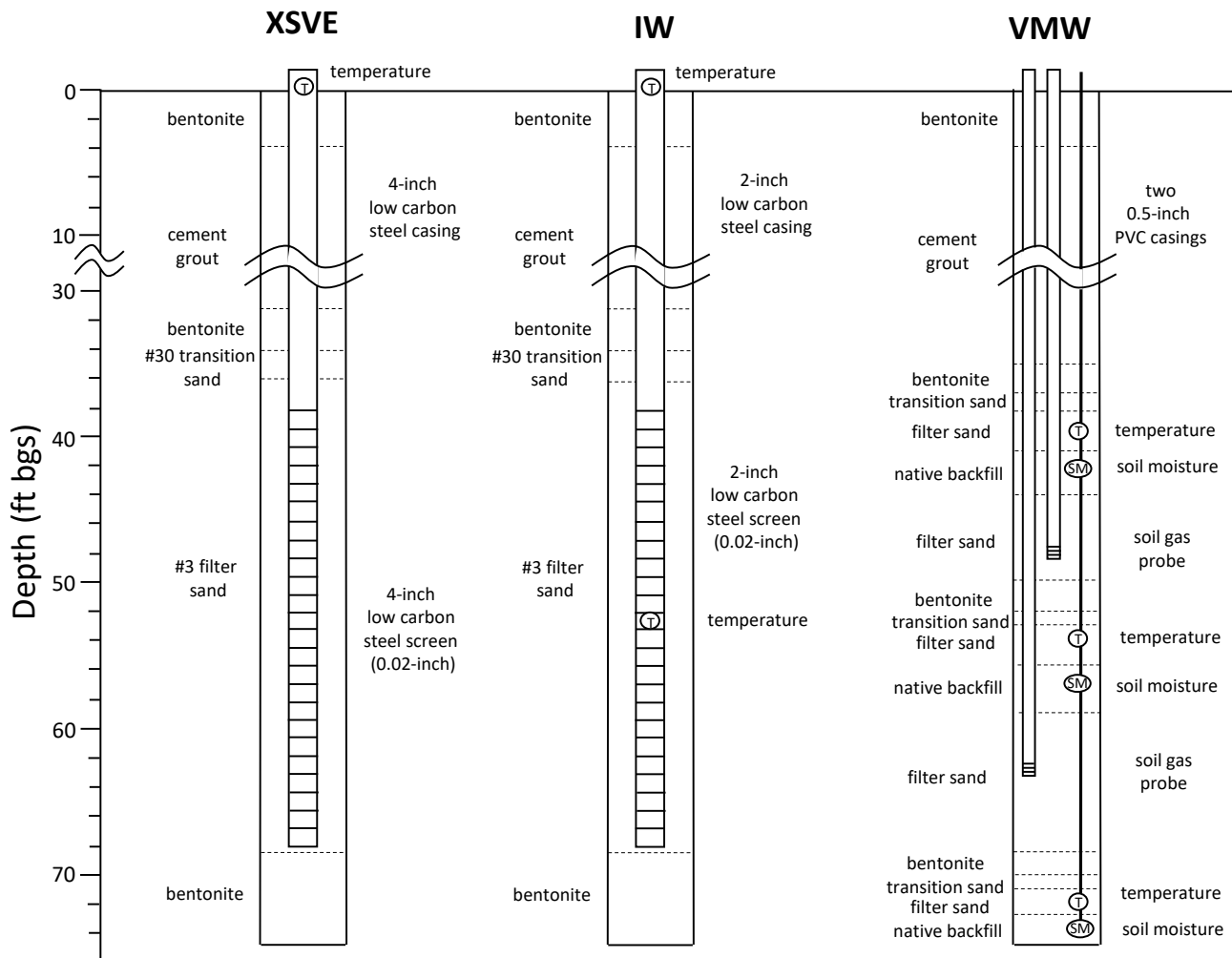

Figure 5.4.1. Well Construction and Instrumentation Details for XSVE Demonstration.

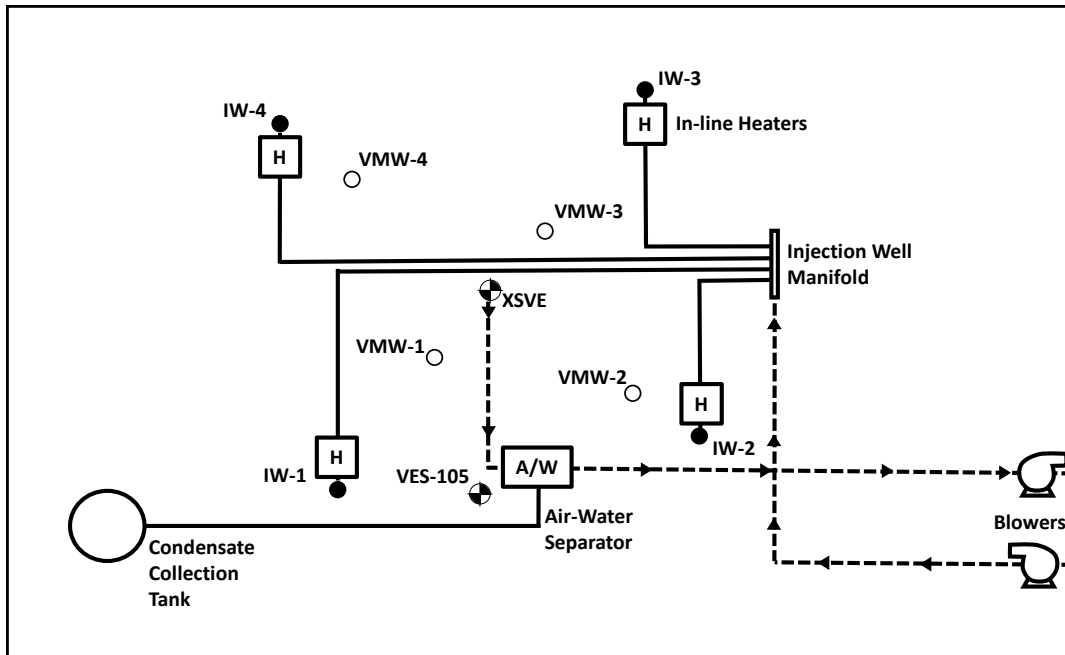

Figure 5.4.2. Schematic of XSVE Demonstration System Design (excluding valves, sensors and controllers).

Injection well piping comes from a rotary positive displacement blower (Tuthill, Model 5516) to a manifold which distributes flow to each of the four injection wells. The manifold contains valves to control and balance the flow distribution. At each of the injection wellheads is an in-line heater (Watlow, tubular flange standard configuration FMN733A00W-34). Figure 5.4.4 shows an injection wellhead and in-line heater assembly. The in-line heaters are configured to cycle off at a specified temperature (at the top of well) and cycle on when below temperature. The extraction well piping is connected to an air-water separator (AWS) and a blower (Roots, rotary positive displacement blower 59 U-RAI). The condensate drain of the AWS is connected to a totalizer and piping to a 500 gallon plastic storage tank. When the AWS condensate tank upper level is reached a pump automatically transfers the contents to the storage tank. The condensate storage tank contents were periodically trucked to the facility waste water treatment plant for disposal. Figure 5.4.5 shows an annotated photograph of the XSVE demonstration site layout. The heat exchange and AWS shown were removed and exchanged with a larger AWS to accommodate higher extraction flow rates.

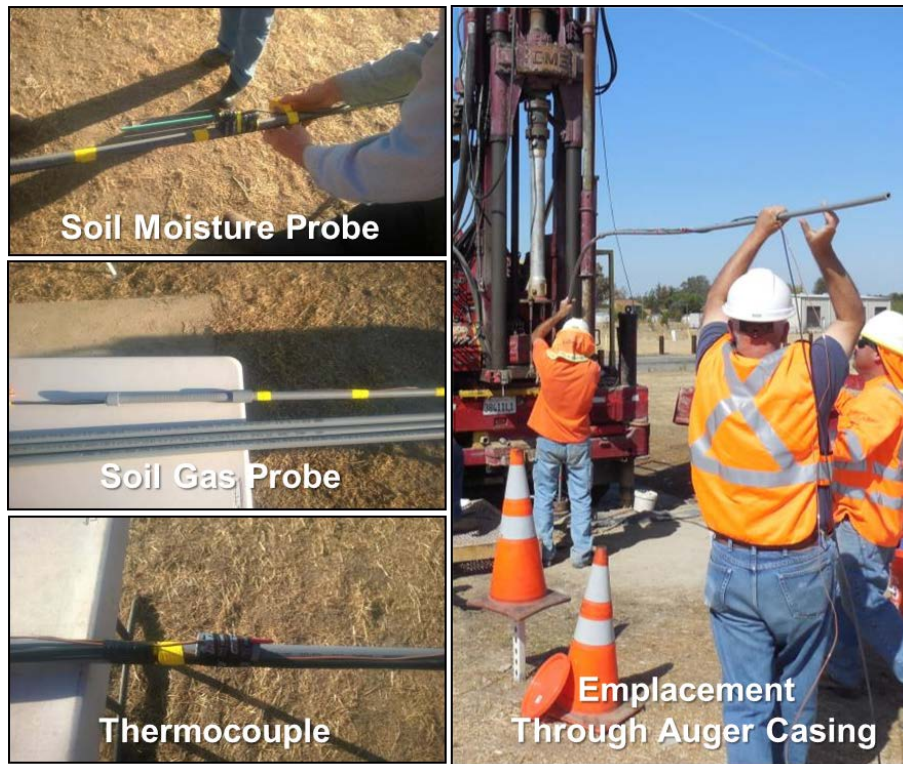

Figure 5.4.3. VMW Instrumentation (soil moisture probes, soil gas probes, and thermocouples).



Figure 5.4.4. Injection Wellheads

Top Left – Prior to insulation and in-line heater. Right – In-line heater. Bottom Left – Finished with insulation, heater, plumbing, thermocouple access, pressure sensor access. Note: Piping along ground surface was changed from PVC to steel.

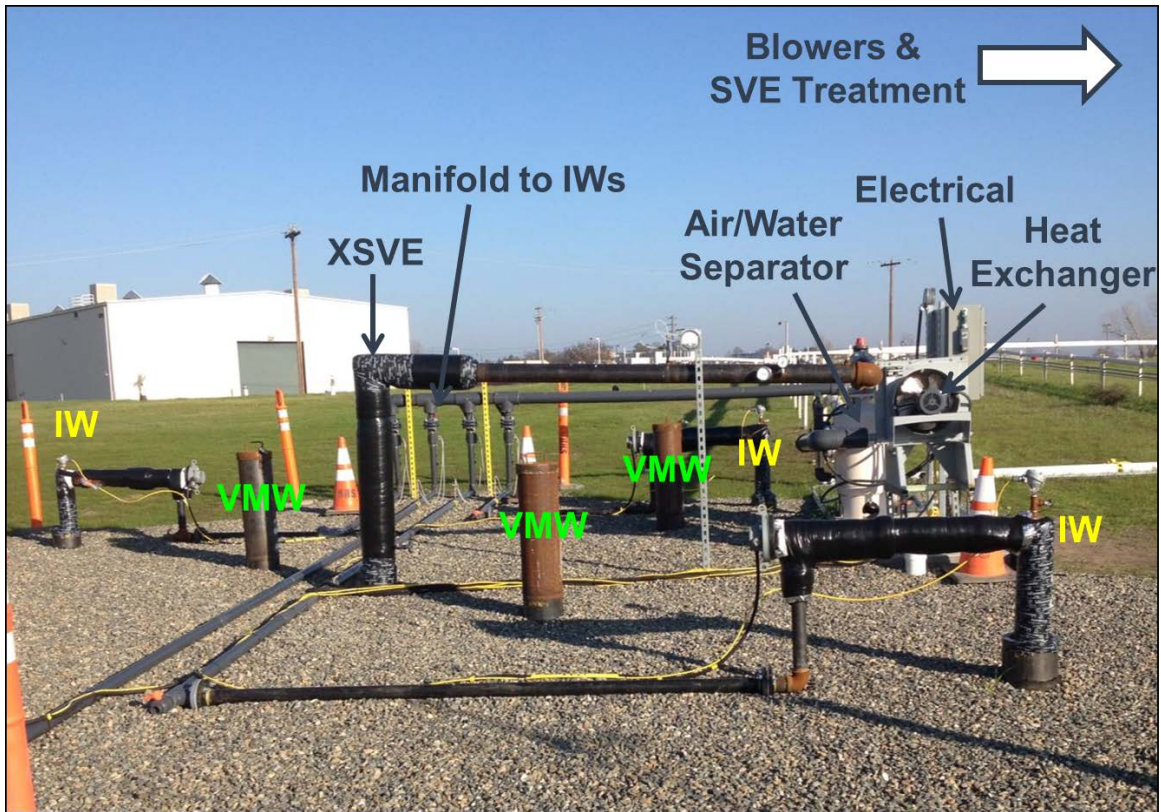

Figure 5.4.5. Layout of XSVE Demonstration Site.

5.5 FIELD TESTING

After construction of the XSVE system, injection and extraction well flows were established. The injection well flows were adjusted and balanced using valves on the injection well manifold. The in-line heaters were turned on (November 19, 2014) and monitored. PVC piping leading towards the in-line heaters melted and were replaced with steel piping (seen in Figure 5.4.5, piping on ground closest to injection well in-line heater). The extraction well flow was being limited by narrow piping the heat exchanger/AWS setup which was replaced with a larger AWS accommodated larger piping. Emergency stop testing was conducted to ensure the system would shut down if blowers turned off and/or temperatures got too high. Injection well temperatures (top of casing) were held at $\sim 100^{\circ}\text{C}$ for the first 1.5 months then was increased to as high as $\sim 160^{\circ}\text{C}$. Generally, as the injection temperature at mid-screen increased (i.e., temperature entering treatment zone) the injection temperature at the top of casing was allowed to decrease.

Once steel piping (near in-line heaters) and new AWS were installed, the XSVE had minimal downtime ($\sim 99\%$ uptime after the first two weeks of operation). Temperatures, flow rates and pressures were measured and recorded on a weekly basis. Treatment zone conditions (VMW locations; temperature, pressure, soil moisture) were measured and recorded on a biweekly basis. Soil vapor samples (VMW locations and extraction well) were taken and analyzed on a two to three month basis. Periodically the condensate holding tank was drained and the water was taken to the facility waste water treatment system for disposal. The XSVE system was operated for 54 weeks (shutting down on December 3, 2015).

After system shutdown, all above ground components of the XSVE were removed from the site, except the electric box so that power could be accessed during the final soil sampling (power box was later removed). The casings for the wells were cut off at ground level to allow drill rig access during the final soil sampling. During all IDW generated during the final soil sampling were containerized and disposed in the facility landfill. Due to concern that the soil boring near the extraction well might damage that well, a new extraction well was installed in the borehole of that soil boring. The project's extraction well (XSVE) was connected to the OU-D SVE system. After drilling operations, landfill cap liner was repaired (see Appendix B for AECOM, 2016, Operable Unit D Landfill Cap Inspection and Maintenance Report).

5.6 SAMPLING METHODS

There were three phases of this field demonstration: 1) pre-XSVE; 2) XSVE process monitoring; and 3) post-XSVE. Table 5.6.1 details the types and approximate numbers of samples analyzed. Incremental sampling approach (ITRC, 2012) was used to reduce the number of soil samples taken. Soil samples were shipped to the laboratory (ALS Environmental, Kelso, WA) in laboratory-provide glass sample jars and analyzed for 1,4-dioxane by EPA Method 8270 (GC/MS) and moisture content by EPA Method 160.3. Soil gas samples were taken using evacuated, cleaned 1 L vapor sampling canisters provided by the laboratory (ALS Environmental, Simi Valley, CA) and analyzed by EPA Method TO-15 (GC/MS). Condensate water samples were shipped to the laboratory (ALS Environmental, Kelso, WA) in 40-mL VOA vials and analyzed for 1,4-dioxane by EPA Method 8270. Temperature readings were made using thermocouples. Pressure measurements were made using Pitot tubes. In situ soil moisture measurements were made using time domain reflectometry-based sensors (Soil Moisture Equipment Corporation, Minitrace Kit, 6050X3K5B, with 20 cm buriable coated waveguides).

Soil borings were obtained at the beginning and end of the demonstration using hollow-stem augur drilling rigs. The split spoons were placed on clean paper sheeting where the soil boring depths could be marked. While in the split spoon, the soil being sampled was crushed using a cleaned stainless steel spoon to make smaller particle sizes and facilitate sampling. Soil being sampled (either 3-foot composite or grab) was place in a cleaned stainless steel bowl and further crushed and mixed. The 3-foot composites from the same depths for the Inner and Outer Rings were combined into a single composite; soil from the first boring was stored in a zip-lock bag until it could be mixed with the soil from the second boring and put into a glass jar and labelled for laboratory analysis. Soil samples were stored on ice, then shipped to the laboratory for analysis. The split spoons in the post-demonstration soil sampling of elevated temperature were cooled prior to sampling as described in Section 5.7.3, otherwise sampling was the same.

During the first vapor sampling event prior to heated air injection, vapor samples were obtained by direct canister sampling. The VMW vapor probes were purged prior to sampling. All other sampling events used the vapor/condensate sampling methodology described in Section 5.3.1.

Table 5.6.1. Approximate Total Number and Types of Samples Collected (excluding on-site analysis and PneuLog).

Pre-XSVE			
Location	Matrix	Analyte/Parameter	# of Samples
Soil borings (VMWs and extraction well)	Soil	1,4-dioxane, soil moisture content	44
Soil vapor probes and extraction well	Soil Gas, lab	1,4-dioxane	9
VMWs	Soil (in situ), field	temperature, soil moisture, pressure	12
Injection wells and extraction well	Vapor, field	temperature, pressure	6
XSVE Process Monitoring			
Location	Matrix	Analyte/Parameter	# of Samples
Soil vapor probes and extraction well	Soil Gas, lab	1,4-dioxane	64
Soil vapor probes and extraction well	Water (soil gas condensate), lab	1,4-dioxane	64
VMWs	Soil (in situ), field	temperature, soil moisture, pressure	336
Injection wells and extraction well	Vapor, field	temperature, pressure	342
Post-XSVE			
Location	Matrix	Analyte/Parameter	# of Samples
Soil borings (VMWs and extraction well)	Soil	1,4-dioxane, soil moisture content	53

5.7 SAMPLING RESULTS

5.7.1 1,4-Dioxane Soil Vapor Sampling Methodology

The condensate/vapor sampling apparatus was used as the soil vapor sampling method for the XSVE demonstration due to elevated temperatures. This section presents an evaluation of this methodology. 1,4-Dioxane results of the condensate/vapor sampling apparatus obtained during the XSVE demonstration are shown in Figure 5.7.1. Total 1,4-dioxane soil vapor concentrations (vapor & condensate) is plotted against its 1,4-dioxane vapor where the condensate has been removed by ice bath condensation coil. A strong correlation was obtained with a slope greater than 1.0 indicating that a substantial amount of 1,4-dioxane was removed with the condensate. Figure 5.7.2 plots the same data as 1,4-dioxane soil vapor concentrations (vapor & condensate) against the fraction of 1,4-dioxane residing in the condensate. A majority of the samples had a substantial fraction of 1,4-dioxane mass in the condensate. The fraction of 1,4-dioxane mass in the condensate was plotted against the temperature near the soil gas probe (or extraction well) in Figure 5.7.3. Also shown in this figure are the values from the laboratory experiments (Section 5.3.1). The

field data reasonably agreed with the lab data up to ~40°C. Above ~40°C the field data showed substantially less 1,4-dioxane in the condensate phase than anticipated based on the laboratory results. This was likely due to significant removal of 1,4-dioxane and water from the portion of the treatment zone that heated up.

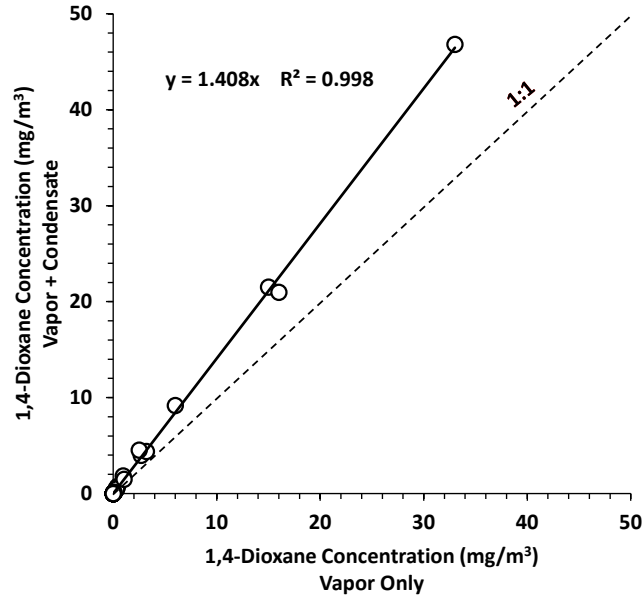

Figure 5.7.1. 1,4-Dioxane Concentrations (mg/m³) Obtained Using Vapor/Condensate Sampling Apparatus during XSVE Operation.

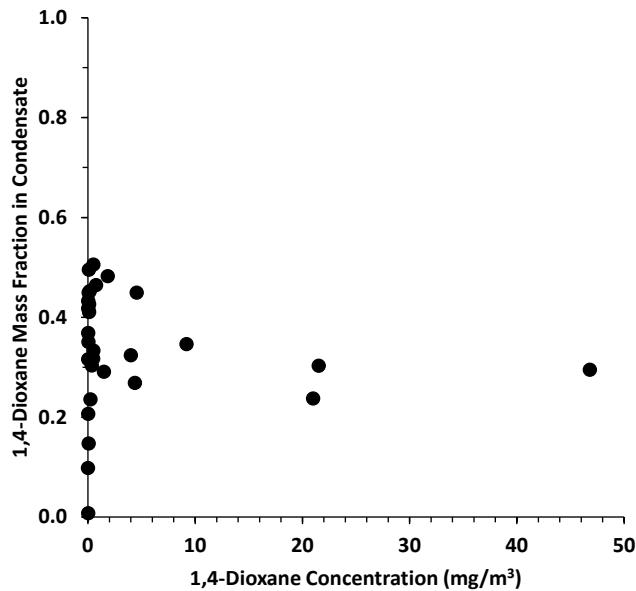

Figure 5.7.2. 1,4-Dioxane Mass Fraction in Condensate vs. 1,4-dioxane Concentration (mg/m³) Obtained Using Vapor/Condensate Sampling Apparatus During XSVE Operation for Samples with Detections in Both Vapor and Condensate Phases.

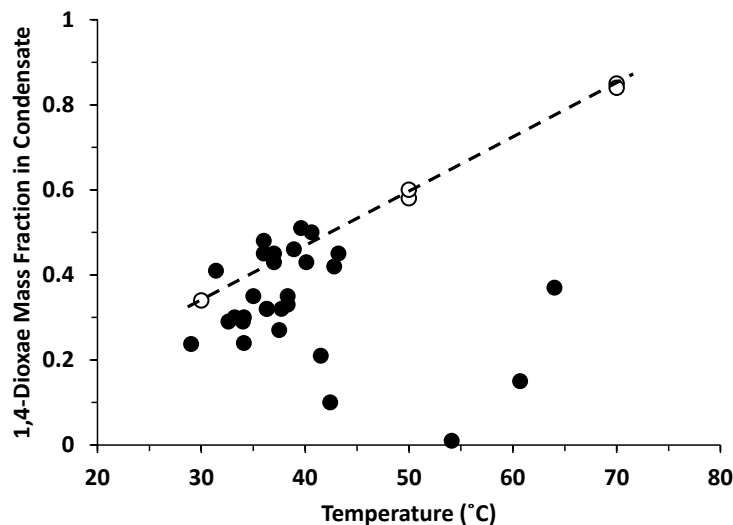

Figure 5.7.3. 1,4-Dioxane Mass Fraction in Condensate at Different Temperatures for Laboratory (open circles; dashed line) and Field (solid circles) Samples Collected During XSVE Operation.

An important practical consideration is whether the direct canister sampling of vapor would have been adequate or whether the use of the vapor/condensate sampling apparatus was necessary. The vapor/condensate apparatus and methodology, although not overly complex is considerably more involved and time-consuming than simply taking a direct canister vapor sample only and requires analysis of two phases instead of one. Table 5.7.1 shows extraction well 1,4-dioxane concentrations obtained by three methods: 1) vapor/condensate sampling apparatus at the wellhead; 2) direct canister vapor sampling and condensate sampling after the AWS; and 3) direct canister vapor sampling at the wellhead. Sampling both vapor and condensate after the AWS is similar to using the vapor/condensate sampling apparatus, where both phases are sampled. The AWS is significantly less efficient in removing vapor moisture (substantially less than 50%) than the use of an ice bath. The results show that incorporating the condensate phase in the sampling after the AWS increase the vapor concentration by less than 3%. Direct vapor sampling only after the AWS compared well to those obtained by the vapor/condensate apparatus (both phases) at the wellhead (see Figure 5.7.4).

Direct vapor canister sampling at the extraction wellhead gave more sporadic results than those after the AWS; although two of the samplings gave comparable results, the other two were at least 80% less than expected. These direct vapor canister samplings were done in duplicate. It is unclear why these two samplings yielded low values for 1,4-dioxane. The on-site contractor, AECOM, took direct vapor canister samples from the extraction well (wellhead) for their OU-D system monitoring. The OU-D-related samplings were done on different days from those for the XSVE project so direct comparison is not possible, however examination of the AECOM data in addition to the XSVE extraction well data provides valuable insight (see Figure 5.7.5). Although sampled on different days, the 1,4-dioxane results of both methods agree well with each other indicating the direct vapor sampling should be adequate.

The vapor/condensate sampling apparatus, although more costly, yields consistent reliable results. On balance, however, it appears that direct vapor canister sampling may be sufficiently accurate for most remediation engineering applications of 1,4-dioxane soil gas sampling at elevated temperatures.

Table 5.7.1. XSVE Extraction Well Effluent 1,4-dioxane Concentrations Taken by 3 Methods: 1) Vapor/Condensate Sampling Apparatus Sampled at Wellhead; 2) Vapor and Condensate Sampled After Air/Water Separator; and 3) Sampled at Wellhead.

Effective vapor concentrations incorporate both vapor and condensate. Duplicates except where noted.

Vapor/Condensate Apparatus (Wellhead)		Vapor & Condensate (after AWS)		Vapor (Wellhead) ($\mu\text{g}/\text{m}^3$)
Vapor Only ($\mu\text{g}/\text{m}^3$)	Both Phases ($\mu\text{g}/\text{m}^3$)	Vapor Only ($\mu\text{g}/\text{m}^3$)	Both Phases ($\mu\text{g}/\text{m}^3$)	
6,000 ^a	9,178 ^a	11,000 ^a	11,041 ^a	1,995
2,500	4,540	5,550	5,608	6,050
955	1,846	1,600 ^a	1,611 ^a	117
1,050	1,481	935	960	1,050

^a Single sample; not duplicate

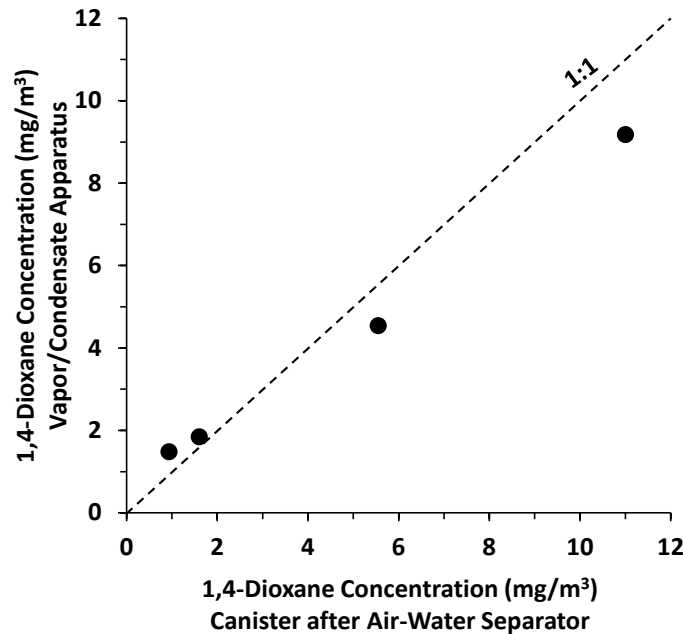

Figure 5.7.4. Comparison of 1,4-dioxane Concentrations Obtained Using: 1) Vapor/Condensate Sampling Apparatus at Well Head and 2) Canister (Without ice bath) After Air-water Separator.

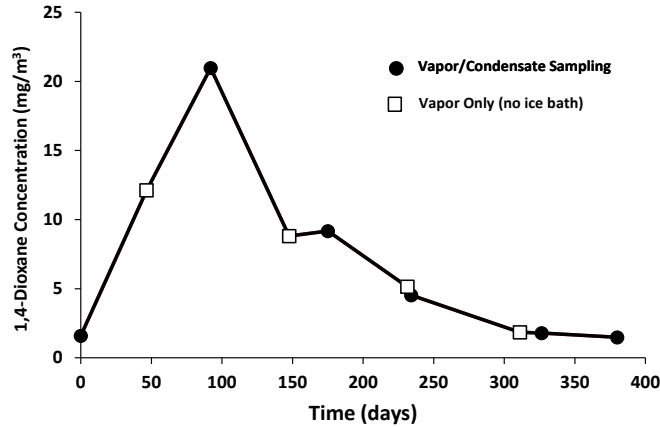

Figure 5.7.5. Extraction Well 1,4-dioxane Concentrations Taken Using 1) Vapor/Condensate Sampling Apparatus and 2) Vapor Canister Only (No Ice Bath).

5.7.2 XSVE System Monitoring

The flow to the injection well manifold, thus the injection wells, is provided by the GAC blower. The GAC blower flow rates and pressures during XSVE operation are shown in Figure 5.7.6. These flow rates are agreement with the sum of the injection well flow rates. Injection well flow rates and pressures during XSVE operation are shown in Figure 5.7.7. Flow rates were generally between 70 and 90 scfm. These flow rates are slightly lower than the design flow rate of 100 scfm each. Since the injection wells provide an excess of air flow needed for the treatment zone, this reduction is not significant. The injection well pressures were generally in the range of 25 to 40 inches water each, slightly lower than the GAC blower pressure. Extraction well flow rates and pressures during XSVE operation are shown in Figure 5.7.8. Extraction well flowrates were generally in the 80 to 120 scfm range.

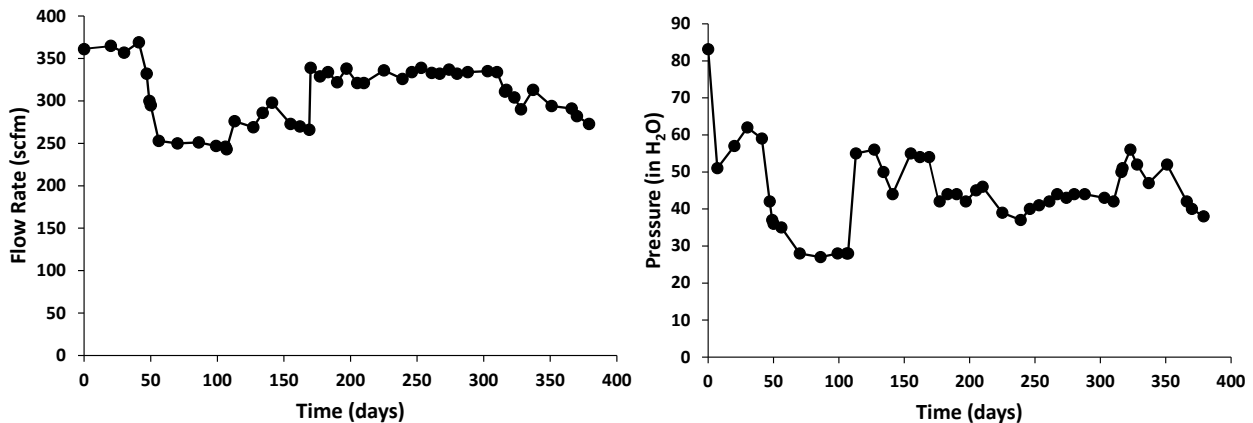

Figure 5.7.6. GAC Blower (to Injection Well Manifold) Flow Rates and Pressures during XSVE Operation.

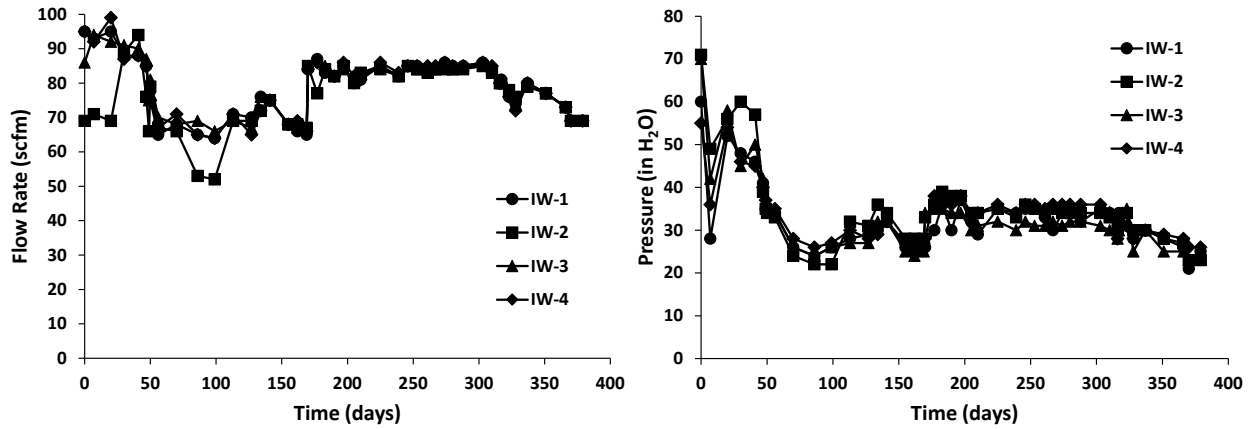

Figure 5.7.7. Injection Well Flow Rates and Pressures During XSVE Operation.

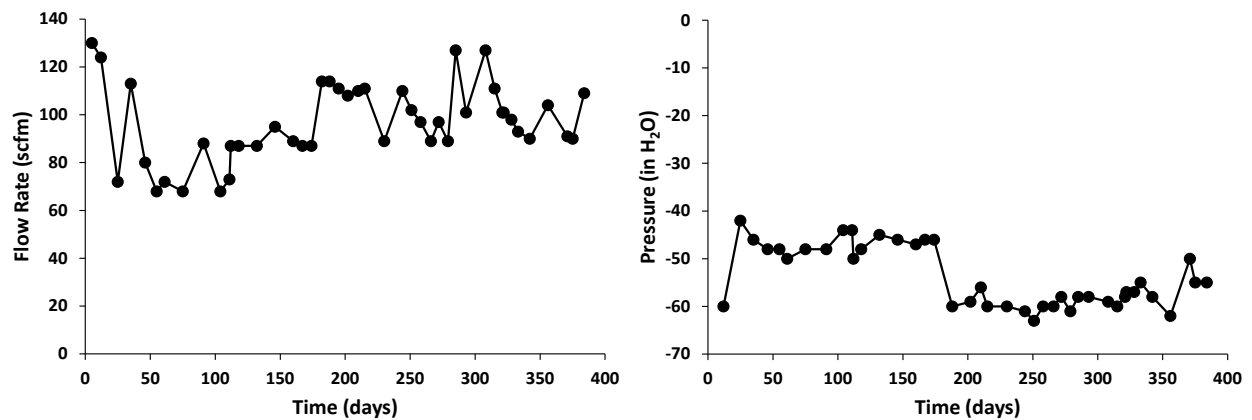

Figure 5.7.8. Extraction Well Flow Rates and Pressures (after AWS) During XSVE Operation.

Injection well temperatures at the wellhead and mid-screen during XSVE operation are shown in Figure 5.7.9. The injection well in-line heaters were controlled by the temperatures set at their respective wellheads. There is a temperature loss from the wellheads to the mid-screen depths. The mid-screen temperatures reflect the temperatures entering the treatment zone. Mid-screen temperatures were generally in the 100 to 120°C range and were allowed to rise above 120°C in the latter part of XSVE operation. These injection temperatures are above the 90°C design temperature and were not difficult to maintain.

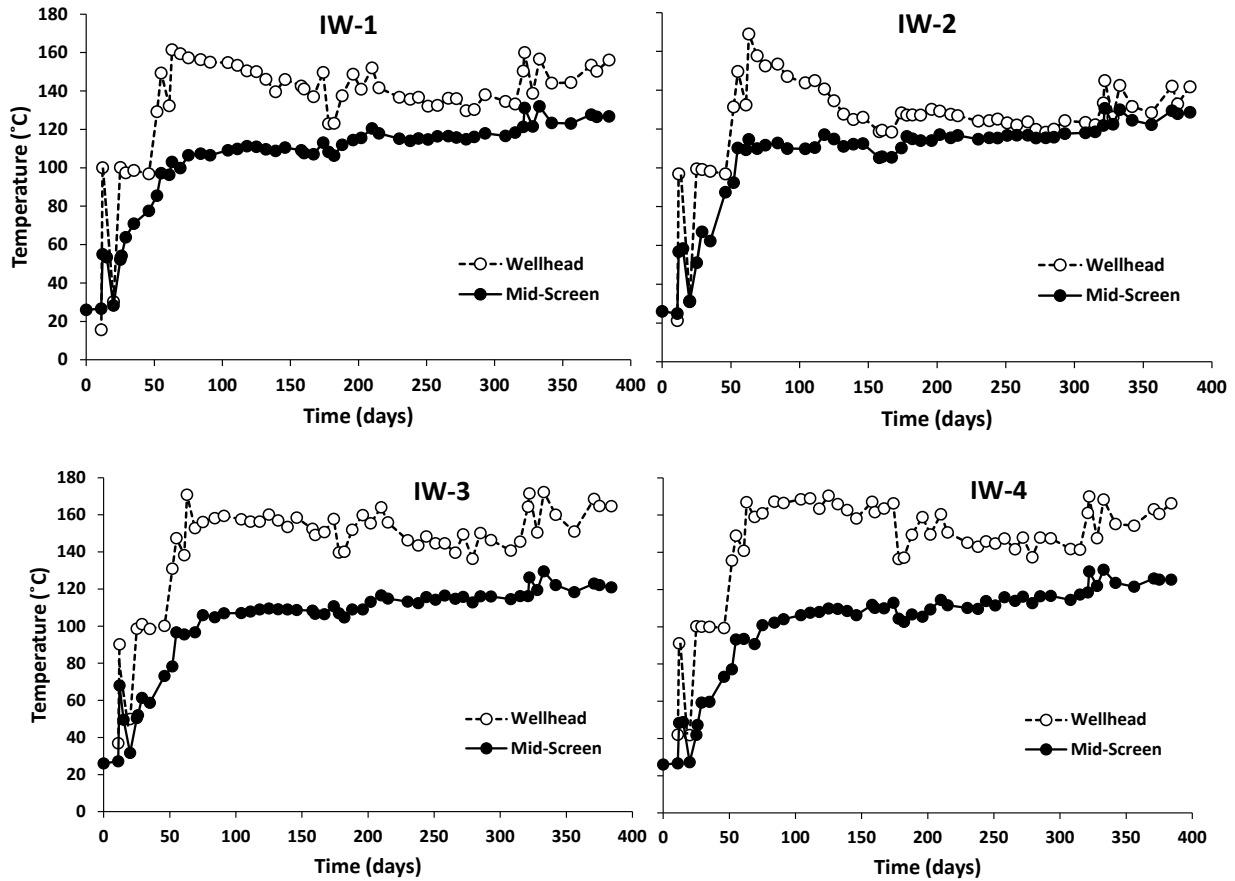

Figure 5.7.9. Injection Well Temperatures at the Wellhead and Mid-screen During XSVE Operation.

Treatment zone temperatures for the VMW locations during XSVE operation are given in Figure 5.7.10. The outer ring (VMW-2 and -4) temperatures were higher due to their proximity to the injection wells. Temperatures reached as high as 90°C in the treatment zone. The upper portion of the outer ring reached higher temperatures than the lower portion. The inner ring treatment zone temperatures reached as high as the 40 to 45°C range with the upper and lower zones being relatively similar. There a temperature rise below the treatment zone at each of the VMW locations. The extraction well temperatures during XSVE operation (Figure 5.7.11) reached the 35 to 40°C range.

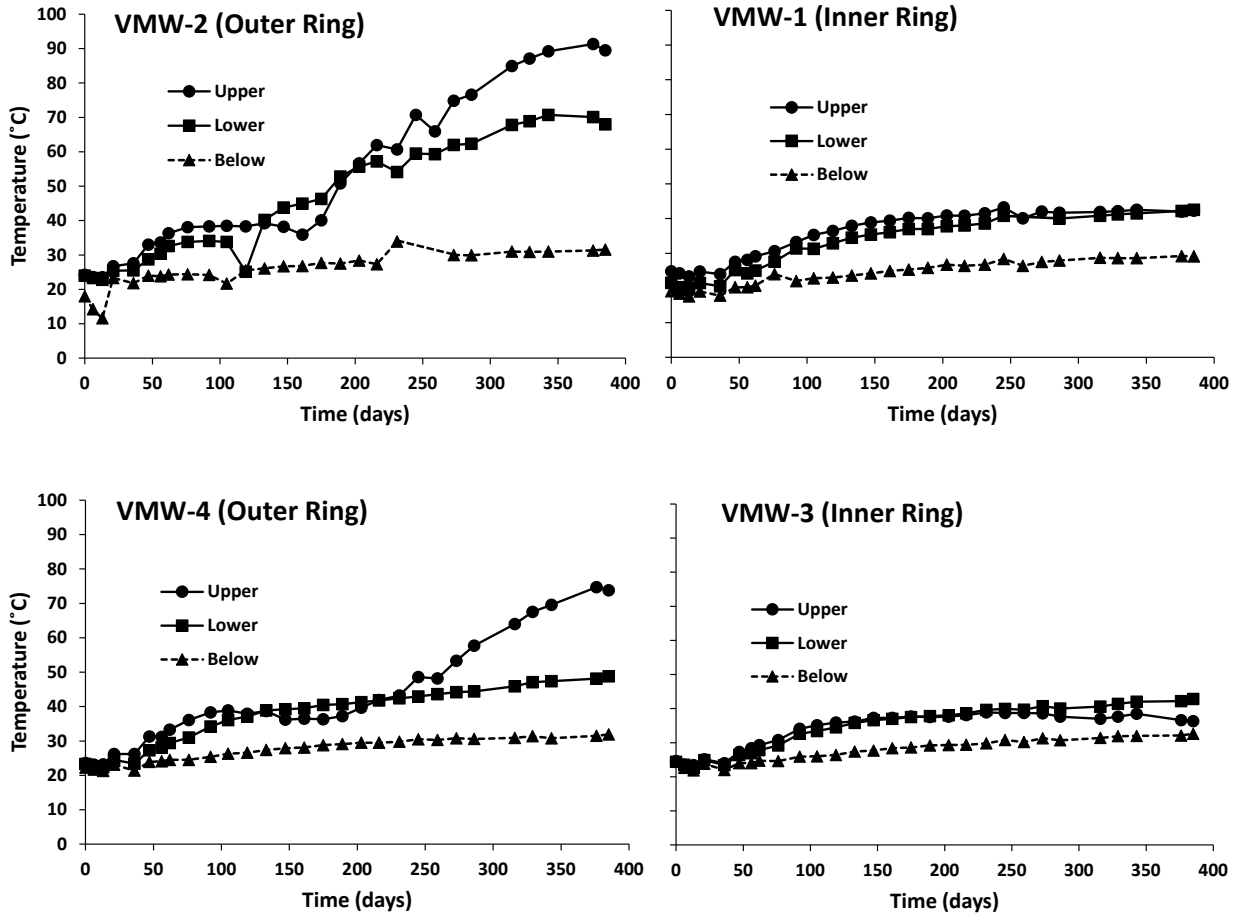

Figure 5.7.10. Outer (VMW-2 and -4) and Inner Ring (VMW-1 and -3) Treatment Zone Temperatures for During XSVE Operation.

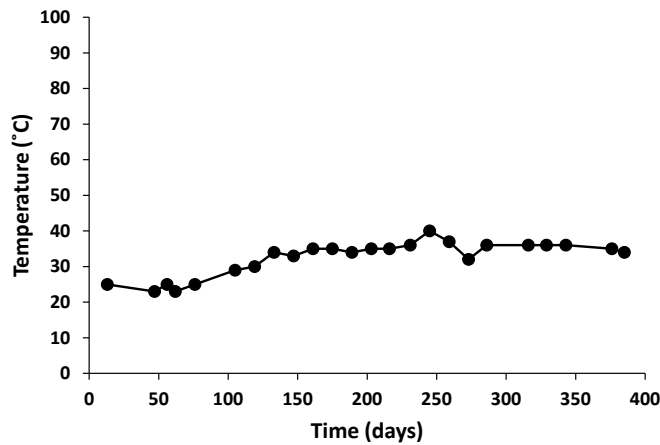

Figure 5.7.11. Extraction Well Temperatures During XSVE Operation.

Treatment zone soil moisture contents (%) during the XSVE operation are given in Figure 5.7.12. All four outer ring soil moisture sensors reached or approached zero during XSVE operation indicating that the soil moisture content in the outer ring was substantially reduced as a result of the XSVE operation. Only one of the four inner ring locations show a decrease in soil moisture content before the end of XSVE operation. The soil moisture content below the treatment zone appeared to increase over operation of XSVE but did not exceed 16%. The soil moisture observations do not appear to indicate substantial condensate that would lead to downward movement of vadose zone water.

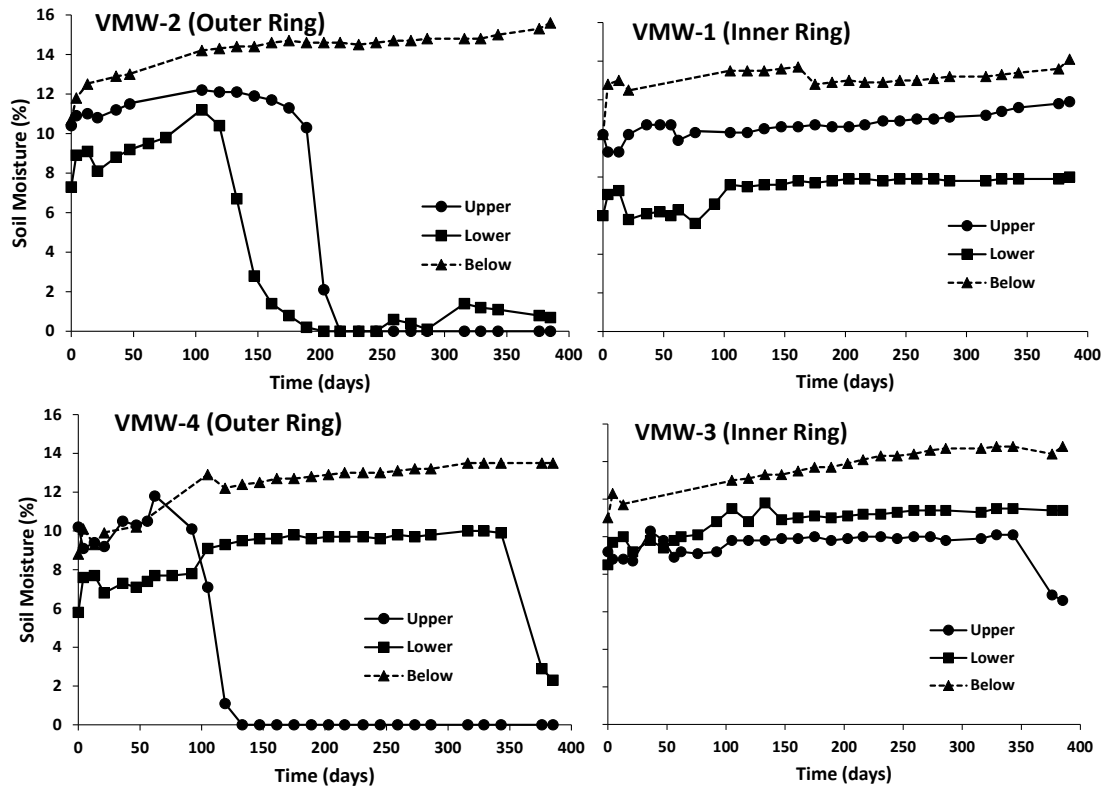

Figure 5.7.12. Outer (VMW-2 and -4) and Inner Ring (VMW-1 and -3) Treatment Zone Soil Moisture Contents for During XSVE Operation.

Treatment zone pressures during XSVE operation are given in Figure 5.7.13. Pressures were generally in the 10 to 15 inches water range with the exception of the inner ring lower zone locations which was generally in the 0 to 5 inches water range.

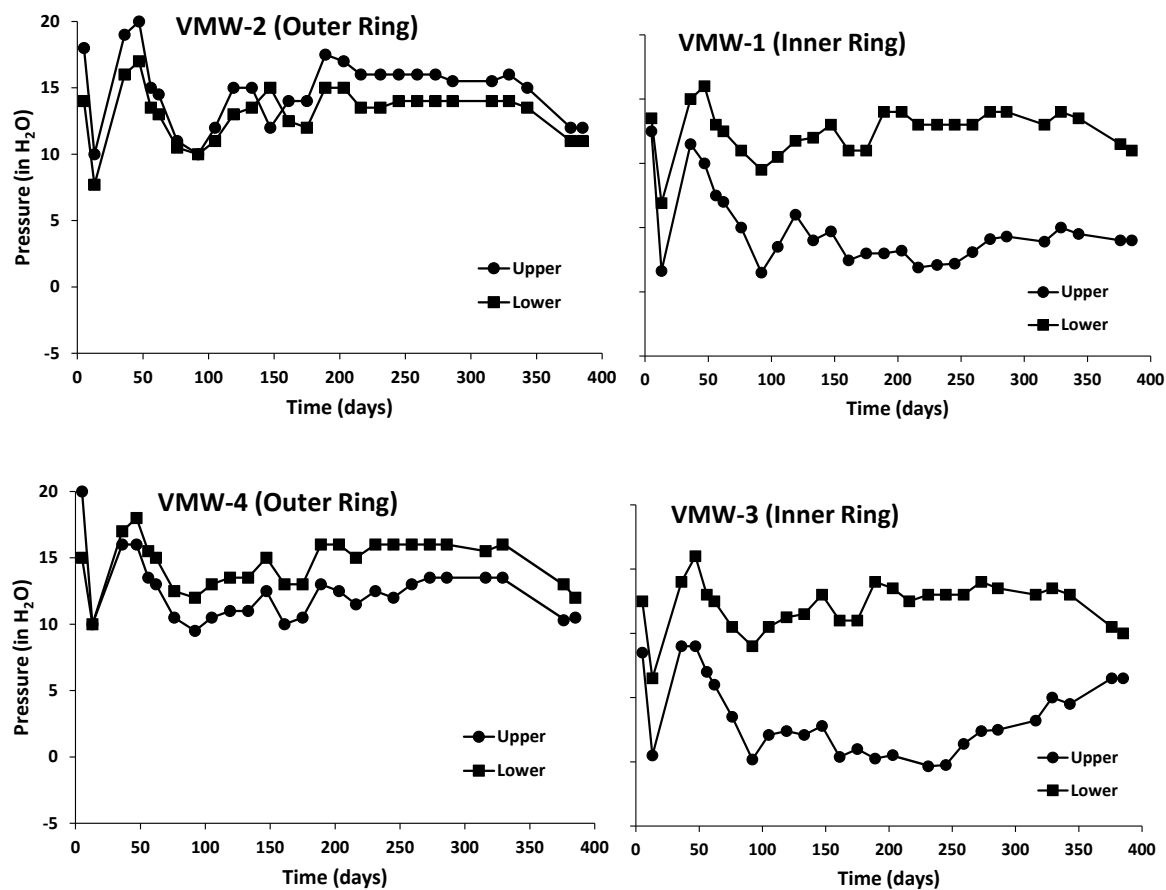

Figure 5.7.13. Outer (VMW-2 and -4) and Inner Ring (VMW-1 and -3) Treatment Zone Pressures for During XSVE Operation.

Treatment zone 1,4-dioxane soil vapor concentrations during XSVE operation are given in Figure 5.7.14. The bulk of 1,4-dioxane in the soil vapor was in the inner ring, especially in VMW-3 where concentrations as high as 47 mg/m³ was observed. These results indicate a heterogeneous distribution of 1,4-dioxane in the treatment zone. Figure 5.7.15 gives the 1,4-dioxane concentration in the extracted soil vapor where levels as high as 21 mg/m³ were observed. The 1,4-dioxane mass removal rates and cumulative mass removed during XSVE operation are shown in Figure 5.7.16. The bulk of 1,4-dioxane removed was during the first half of XSVE operation.

1,4-Dioxane mass removal rates and cumulative mass removed for the XSVE system in compared with the OU-D and VES-105 are shown in Figure 5.7.17. Prior to the XSVE system when VES-105 was still in operation it appeared as though the bulk of 1,4-dioxane observed in OU-D was due to VES-105. The one OU-D sample taken after VES-105 was shut down and before the XSVE system was operating showed low 1,4-dioxane removal. Once the XSVE was brought on-line, the 1,4-dioxane observed in OU-D appears to be predominantly due to XSVE.

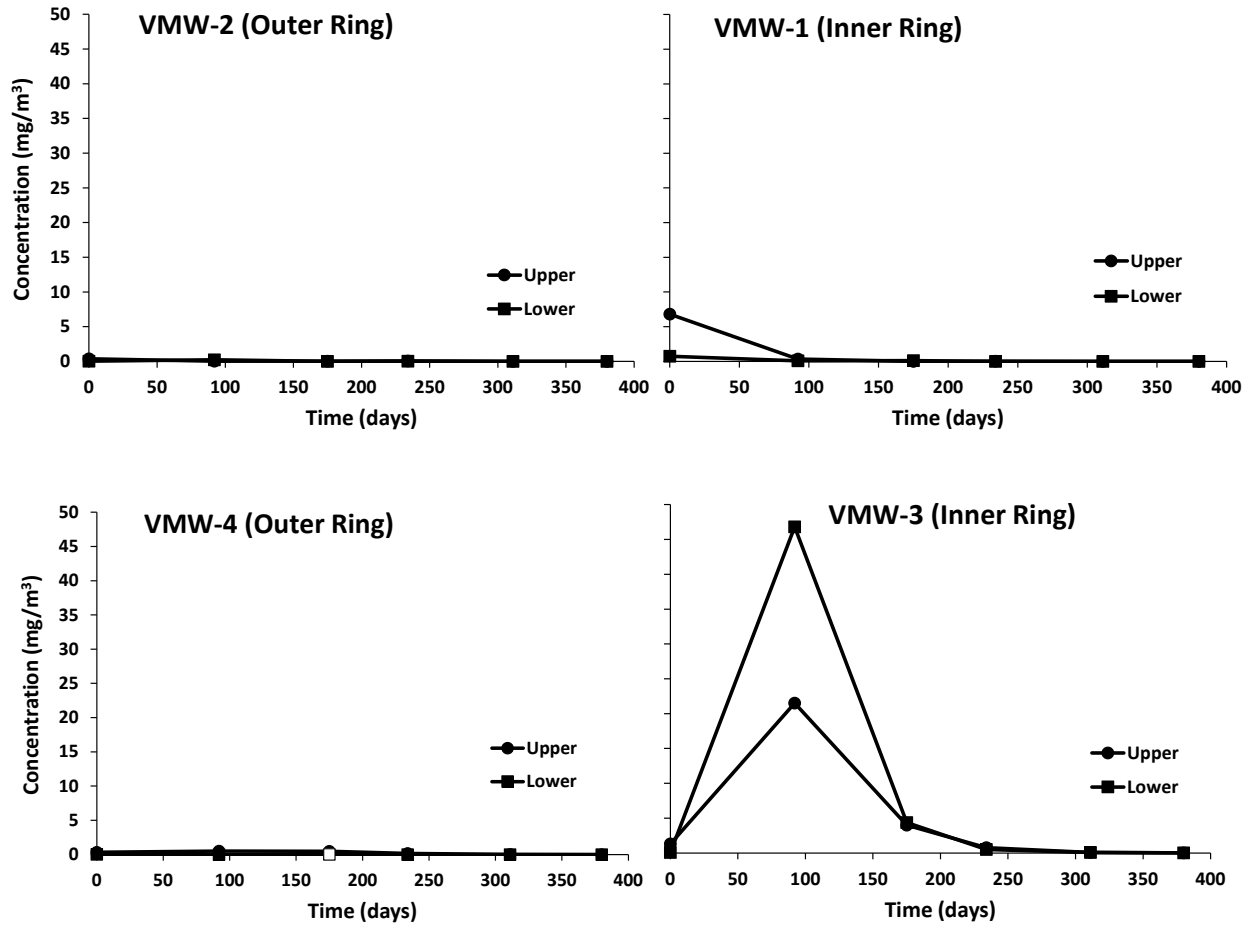

Figure 5.7.14. Outer (VMW-2 and -4) and Inner Ring (VMW-1 and -3) Treatment Zone 1,4-dioxane Concentrations (mg/m³) in Soil Gas for During XSVE Operation.

Open symbols are non-detects plotted as detection limits.

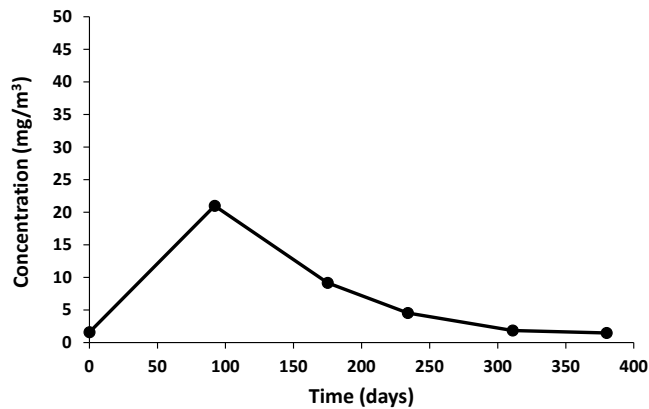

Figure 5.7.15. Extraction Well 1,4-dioxane Soil Vapor Concentrations During XSVE Operation.

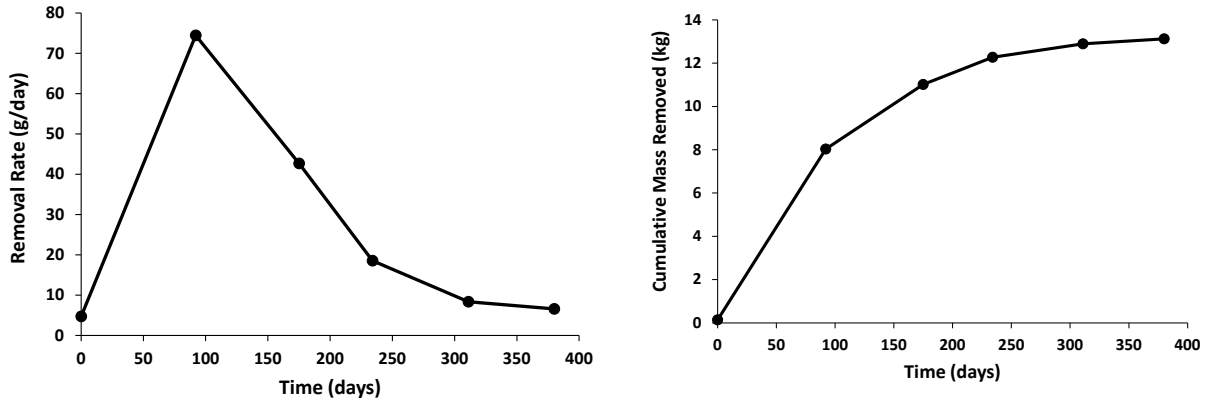

Figure 5.7.16. 1,4-Dioxane Mass Removal Rates and Cumulative Mass Removed During XSVE Operation.

Note: A cumulative mass removed of 13 kg 1,4-dioxane corresponds to ~ 94% removal based on pre- and post-demonstration soil sampling.

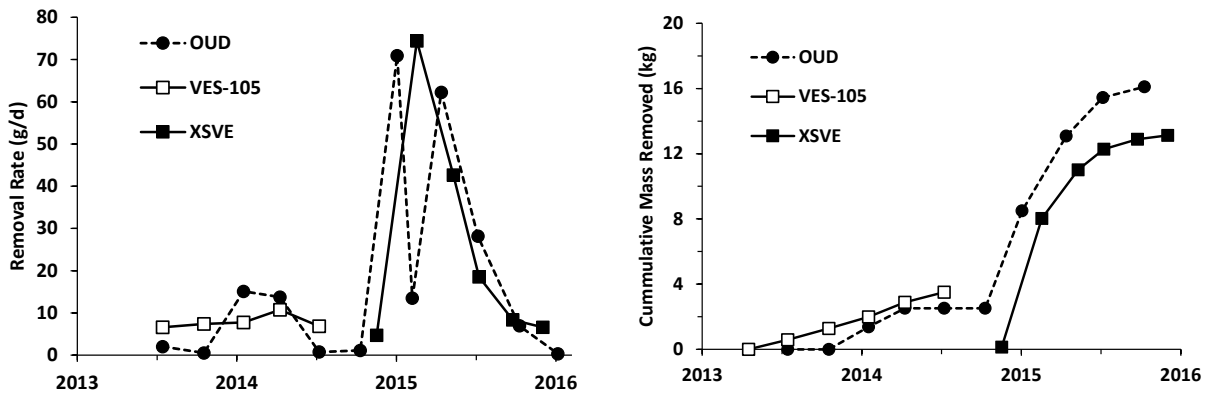

Figure 5.7.17. 1,4-Dioxane Mass Removal Rates and Cumulative Mass Removed During XSVE Operation Compared with Those for OU-D and VES-105.

The cumulative condensate volume collected during XSVE operation is given in Figure 5.7.18. This is a fraction of water vapor extracted from the treatment zone due to the inefficient AWS. Estimated power consumption (based on power bills) is given in Figure 5.7.19. Once the XSVE system injection wells were brought up to temperature the power consumption was relatively constant. Figure 5.7.20 shows the proportion of power as injected heat which tended to range between 50 and 70%. The proportion of the injected heat entering the treatment zone during XSVE operation is given in Figure 5.7.21. Initially ~10% of the injected heat entered the treatment zone and this increased to ~30% by the end of XSVE operation. The proportion of injected heat loss above the treated during XSVE operation is given in Figure 5.7.22. The loss of injected heat above the treatment zone was initially ~50% then dropped to ~25%.

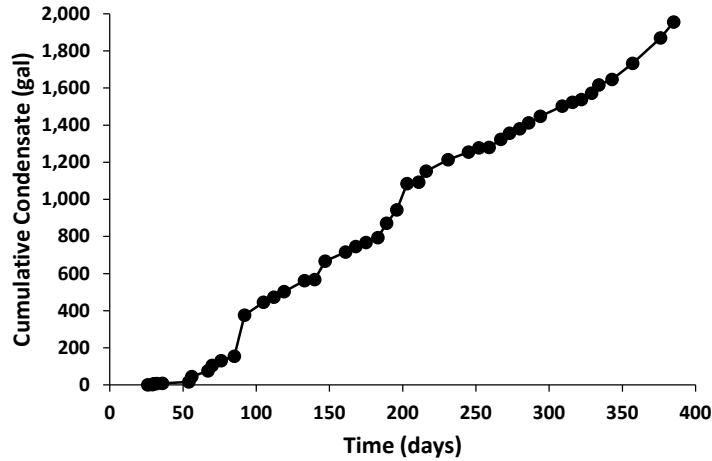

Figure 5.7.18. Cumulative Condensate Volume (Air-water Separator and Piping Low-point Drain) During XSVE Operation.

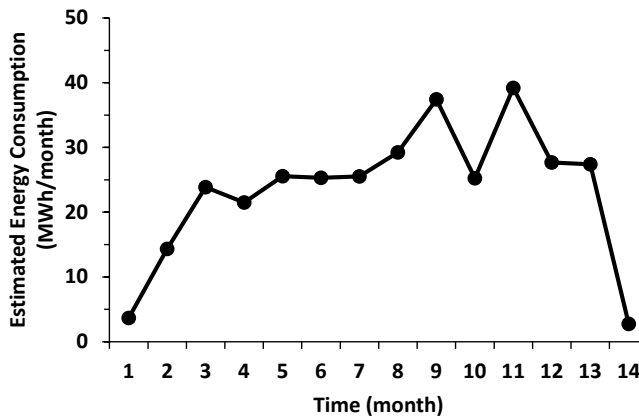

Figure 5.7.19. Estimated Power Consumption During XSVE Operation.



Figure 5.7.20. Proportion of Estimated Power Consumption as Injected Heat During XSVE Operation.

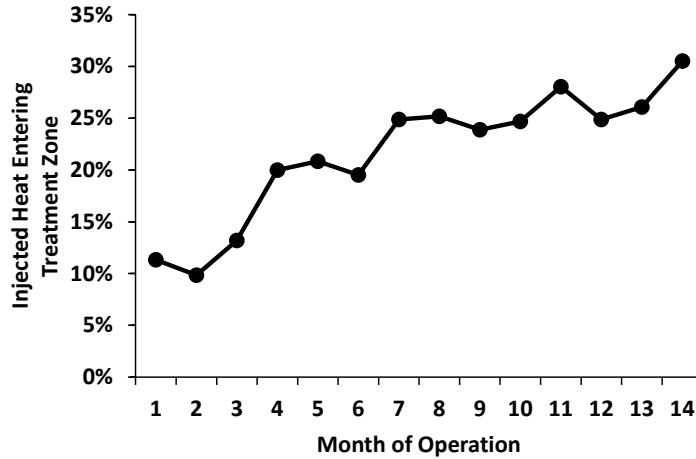

Figure 5.7.21. Proportion of Injected Heat Entering Treatment Zone During XSVE Operation.

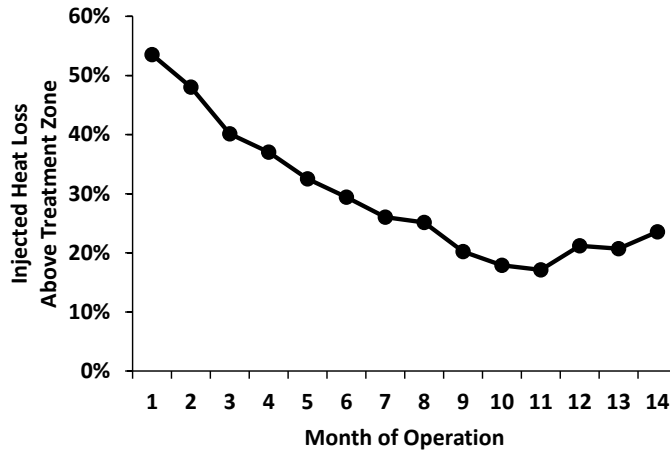

Figure 5.7.22. Proportion of Injected Heat Loss to Above Treatment Zone During XSVE Operation.

5.7.3 Post-Demonstration Soil Sampling

Post-demonstration drilling and soil sampling was done a week after XSVE shut-down. The demonstration site was partially decommissioned to allow for safe access of the drill rig. Figure 5.7.23 shows locations of the post-demonstration soil borings. The treatment zone soils reached as high as 90°C, so the hollow stem auger split spoons had to be cooled down before the spoons could be opened for soil sampling. Figure 5.7.24 shows the cool-down procedure where the spoons were wrapped in plastic (to prevent water from melting ice from reaching soil), then placed within a wooden cradle and covered with ice. An infrared temperature gun was used to monitor temperature of the core, however the plastic made the readings problematic. Monitoring core temperature by physical touch was more useful. Cooling times ranged from ~20 to ~45 minutes per spoon. The outer ring borings tended to cool faster since less soil moisture was present. Once cooled, soil was sampled as described in Section 5.6.

1,4-Dioxane soil concentrations for the pre- and post-demonstration soil borings are given in Figure 5.7.25. The screened interval (e.g., treatment zone) is indicated. Substantial reduction in 1,4-dioxane concentrations occurred throughout the treatment zone. Assuming the Outer Ring, Inner Ring and Center configuration in Figure 5.1.2, there was a ~94% reduction in 1,4-dioxane concentration in the treatment zone.

Soil moisture content for the pre- and post-demonstration soil borings are shown in Figure 5.7.26. A reduction in soil moisture is apparent in the outer ring soil borings, while the center remained essentially unchanged. There was a ~45% reduction in soil moisture content in the treatment zone as a whole.

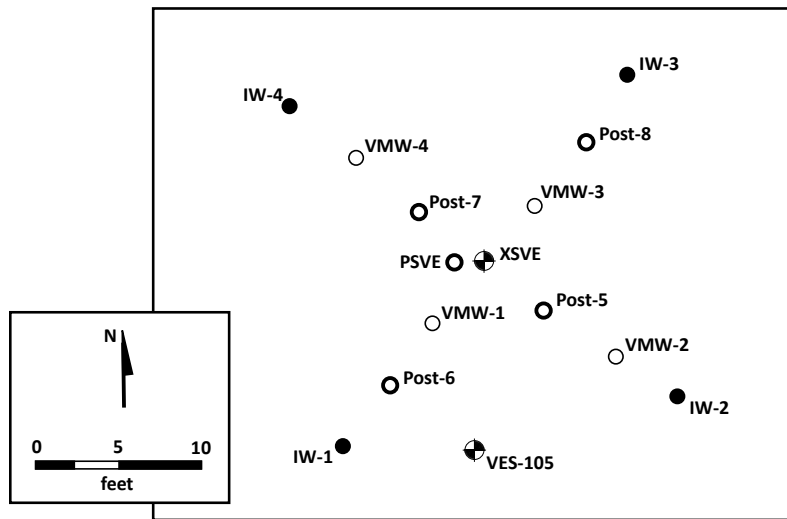

Figure 5.7.23. Locations of Post-demonstration Soil Borings.

Center: PSVE; Inner Ring; Post-5 & Post-7; Outer Ring; Post-6 & Post-8.



Figure 5.7.24. Split Spoon Cool Down Procedure During Post-demonstration Soil Sampling.

Split spoons are: wrapped in plastic to prevent water from getting into core (left) and covered with ice while in wooden cradle.

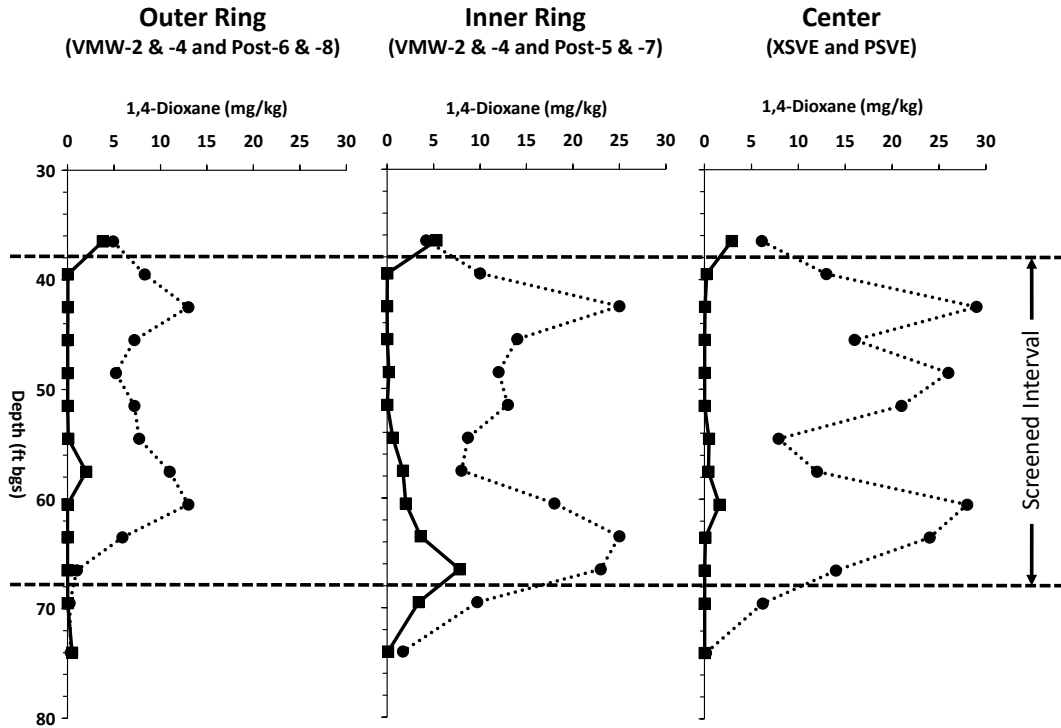

Figure 5.7.25. 1,4-Dioxane Soil Concentrations (mg/kg) Before (circle, dashed line) and After (square, solid line) XSVE Operation.

Depths are the centers of the 3-foot composite intervals.

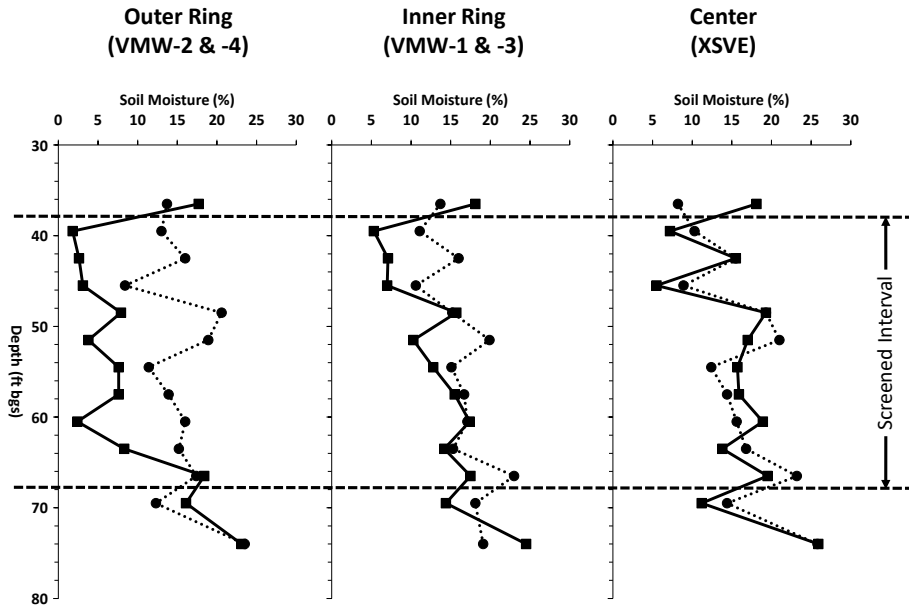

Figure 5.7.26. Soil Moisture Concentrations (%) Before (circle, dashed line) and after (square, solid line) XSVE Operation.

Depths are the centers of the 3-foot composite intervals.

5.8 HYPEVENT XSVE FOR 1,4-DIOXANE

5.8.1 Overview

HypeVent XSVE for 1,4-dioxane (HypeVent XSVE) is a spreadsheet-based tool that runs in Microsoft Excel[®]. It was developed for this ESTCP project in anticipation of remediation professionals need for a screening-level feasibility assessment and design tool for XSVE applications. HypeVent XSVE facilitates quick exploration of the best-case performance for 1,4-dioxane removal from soils using the XSVE technology demonstrated in this project.

In brief, users enter the target treatment zone size, initial 1,4-dioxane and soil moisture concentrations, ambient site conditions, and operating conditions and then they can assess the potential for XSVE to achieve their remediation goals (cleanup level, remediation time, etc.) under ideal conditions. The primary operating inputs that users manipulate are the vapor flow rate through the target treatment zone and temperature that ambient air is heated to prior to injection. By changing the injected air temperature between ambient and elevated temperatures, the user can compare best-case performance of conventional SVE and XSVE treatments.

HypeVent XSVE predicts 1,4-dioxane and moisture removal rates and concentration changes in treatment zone soils with time for the idealized conditions discussed below. It also projects the corresponding changes in leachate and soil vapor concentrations as remediation progresses. Sample output is presented below in Figure 5.8.1 for the case of 100 ft³/min air flow through a nominal 30-ft wide x 30-ft long x 20-ft thick treatment zone, 20 mg/kg initial 1,4-dioxane concentration, 10% by weight initial soil moisture, and with ambient air (20°C, 25% relative humidity) being heated to 100°C prior to injection.

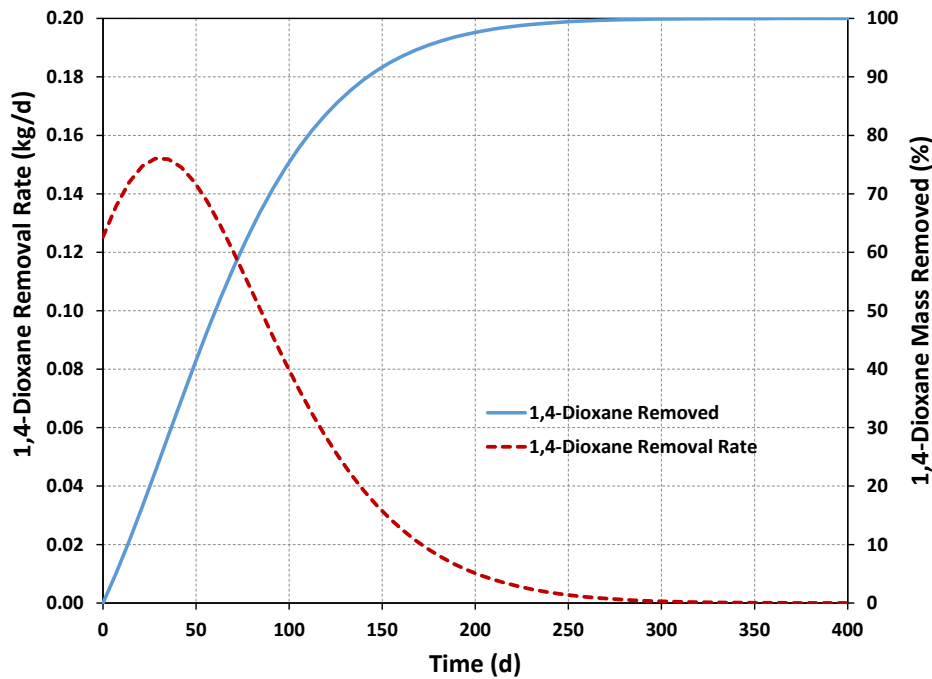

Figure 5.8.1. Sample HypeVent XSVE Output (“Results – 1,4D Removal” worksheet tab).

5.8.2 HypeVent XSVE Screening-Level Calculations

HypeVent XSVE performs screening-level performance calculations. These provide an upper-bound best-case performance estimate. HypeVent XSVE is based on the simplified conceptualization of the XSVE process shown in Figure 5.8.2. The treatment zone is equipped with centralized vapor extraction and peripheral injection of heated ambient air, although HypeVent XSVE is equally applicable to reverse well configurations with centralized hot air injection and peripheral extraction. The portion of the injected air that enters the treatment zone and travels to extraction wells delivers energy to, and removes 1,4-dioxane and soil moisture from the treatment zone.

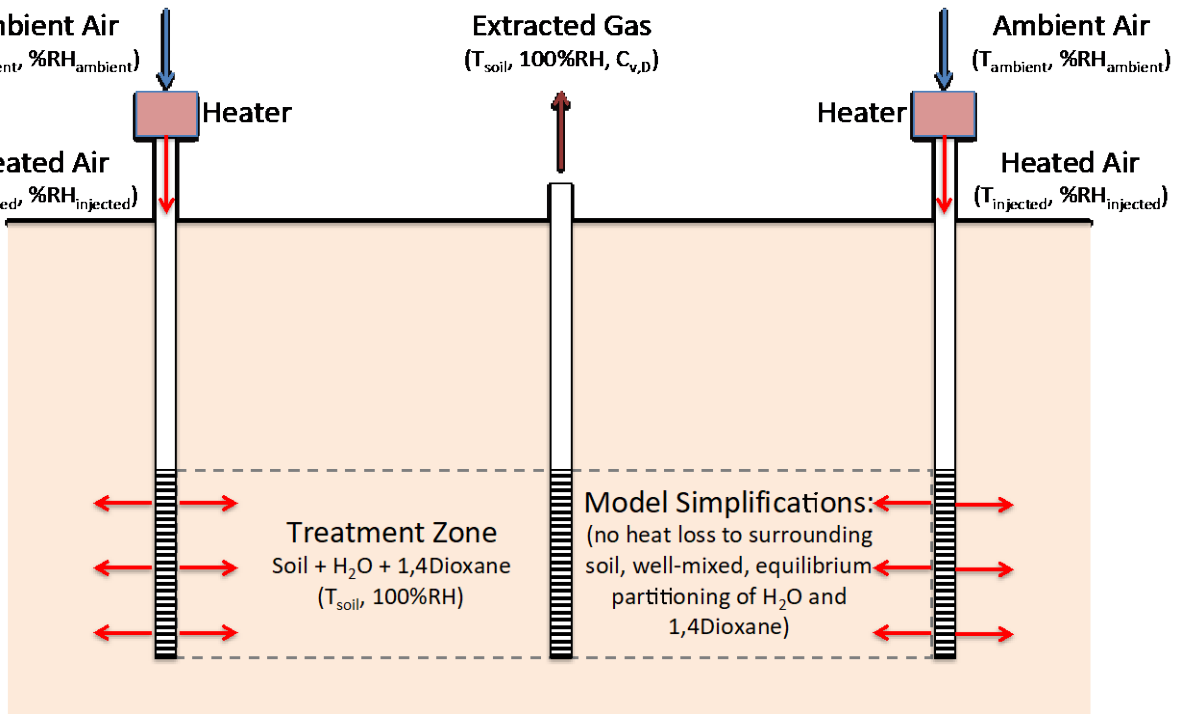

Figure 5.8.2. Simplified Conceptualization of the XSVE Treatment Process.

The equations embedded in HypeVent XSVE assume an idealized process involving the following:

- An isolated treatment zone with no exchange of 1,4-dioxane, water, air, or energy between soils inside and outside the treatment zone.
- Uniform concentrations of 1,4-dioxane and water, and uniform temperature within the treatment zone.
- 1,4-Dioxane dissolved in the soil moisture without sorption to soil surfaces, given its high water solubility and low sorption potential.
- Equilibrium partitioning between 1,4-dioxane dissolved in soil moisture and in soil vapor, and 100% relative humidity in the soil gas, as long as liquid water is present in the soil.

- Temperature-dependent 1,4-dioxane Henry's Law Constant and vapor pressure of water; constant (independent of temperature) soil, water, and air heat capacities and enthalpy of vaporization for water.

Actual XSVE applications will involve heat loss to soils outside the treatment zone, flow of some unheated ambient air pulled into the treatment zone, non-uniform temperature and moisture fronts that move outward from the heated air injection points, and non-equilibrium partitioning. Thus, the HypeVent XSVE predictions should be considered upper-bound best-case performance estimates when using them in decision-making.

5.8.3 HypeVent XSVE Theory

HypeVent XSVE performs the following inter-connected energy and mass balances and partitioning calculations:

- An overall energy balance on the treatment zone, considering the energy delivered in the injected air and removed in the extracted gas flow; this equation yields the predicted changes in the treatment zone temperature with time.
- Temperature-dependent partitioning coefficients (1,4-dioxane Henry's Law Constant and water vapor pressure); these equations are central to predicting the vapor-phase concentrations and removal of 1,4-dioxane and water in the extracted vapors with time.
- Mass balances on 1,4-dioxane and water. The former is removed from the treatment zone by the extracted gas flow, while the latter is both delivered in the injected air (in proportion to the ambient air percent relative humidity) and removed by the extracted gas flow (at 100% relative humidity). These equations determine the 1,4-dioxane and moisture concentrations in soil with time.

The equations and associated definition of terms are presented in Tables 5.8.1 and 5.8.2. The time-dependent differential energy balance and mass balance equations are solved for discrete time steps using an explicit finite-difference algorithm.

Table 5.8.1. HypeVent XSVE Equations.

Overall energy balance:

$$\frac{d}{dt} \{ \dot{m}_{\text{soil}} C_{p,\text{soil}} (T_{\text{soil}} - T_{\text{ref}}) + \dot{m}_{w,T} C_{p,wL} (T_{\text{soil}} - T_{\text{ref}}) + \dot{m}_{w,v} \Delta H_{w,\text{vap}} + \dot{m}_{\text{air}} C_{p,\text{air}} (T_{\text{soil}} - T_{\text{ref}}) \} =$$

$$\left\{ \dot{m}_{\text{air,in}} C_{p,\text{air}} (T_{\text{in}} - T_{\text{ref}}) + \dot{m}_{w,\text{in}} [C_{p,wL} (T_{\text{in}} - T_{\text{ref}}) + \Delta H_{w,\text{vap}}] \right\} - \left\{ \dot{m}_{\text{air,out}} C_{p,\text{air}} (T_{\text{soil}} - T_{\text{ref}}) + \dot{m}_{w,\text{out}} [C_{p,wL} (T_{\text{soil}} - T_{\text{ref}}) + \Delta H_{w,\text{vap}}] \right\}$$

Temperature dependent partitioning coefficients¹:

$$H_{14D}(T_{\text{soil}} + 273.15) = \frac{\exp\left(37.3025 - 24.3009 \frac{298.15}{(T_{\text{soil}} + 273.15)} + 4.8084 \ln\left(\frac{(T_{\text{soil}} + 273.15)}{298.15}\right) - 9.7034 \left(\frac{(T_{\text{soil}} + 273.15)}{298.15}\right)\right)}{(101.325)(0.0821)(T_{\text{soil}} + 273.15)(55.55)}$$

$$P_{v,w}(T_{\text{soil}} + 273.15) = \frac{10^{\left(\frac{8.07131}{(T_{\text{soil}} + 273.15)} - \frac{1730}{(T_{\text{soil}} + 273.15)^2}\right)}}{760}$$

Mass balances on 1,4-dioxane, water, and air:

$$\frac{dm_{14D}}{dt} = -\dot{m}_{14D,\text{out}}$$

$$\dot{m}_{14D,\text{out}} = Q_{\text{air,STP}} \left(\frac{T_{\text{soil}} + 273.15}{273.15} \right) H_{14D}(T_{\text{soil}} + 273.15) \left(\frac{m_{14D}}{m_{w,\text{soil}}} \right)$$

$$\frac{dm_{w,T}}{dt} = \left\{ \dot{m}_{w,\text{in}} - \dot{m}_{w,\text{out}} \right\}$$

$$\dot{m}_{w,\text{in}} = Q_{\text{air,STP}} \left(\frac{T_{\text{ambient}} + 273.15}{273.15} \right) \left(\frac{\%RH_{\text{ambient}}}{100} \right) \left(\frac{P_{v,w}(T_{\text{ambient}} + 273.15) M_{w,H_2O}}{R(T_{\text{ambient}} + 273.15)} \right)$$

$$\dot{m}_{w,\text{out}} = Q_{\text{air,STP}} \left(\frac{T_{\text{soil}} + 273.15}{273.15} \right) \left(\frac{P_{v,w}(T_{\text{soil}} + 273.15) M_{w,H_2O}}{R(T_{\text{soil}} + 273.15)} \right)$$

$$\dot{m}_{\text{air,in}} = \dot{m}_{\text{air,out}} = Q_{\text{air,STP}} \left(\frac{PM_{w,\text{air}}}{R(273.15)} \right)$$

¹ Henry's Law Constant for 1,4-dioxane predicted by Ondo and Dohnal, 2007. Water vapor pressure equation is from Yaws and Yang, 1989.

Table 5.8.2. Nomenclature for HypeVent XSVE Equations Presented in Table 5.8.1.

$C_{p,air}$	=	heat capacity of air [kJ/kg-C]
$C_{p,soil}$	=	heat capacity of soil [kJ/kg-C]
$C_{p,wL}$	=	heat capacity of liquid water [kJ/kg-C]
$C_{p,wv}$	=	heat capacity of water vapor [kJ/kg-C]
$\Delta H_{w,vap}$	=	specific enthalpy of water vaporization [kJ/kg]
H_{14D}	=	1,4-dioxane Henry's Law Constant [L-water/L-vapor]
$m_{w,14D}$	=	mass of 1,4-dioxane in treatment zone [kg]
m_{air}	=	mass of air in treatment zone [kg]
m_{soil}	=	mass of soil in treatment zone [kg]
$m_{w,soil}$	=	mass of liquid water in treatment zone [kg]
$m_{w,T}$	=	total mass of (liquid + vapor) in treatment zone [kg]
$m_{w,v}$	=	mass of water vapor in treatment zone [kg]
$M_{w,air}$	=	molecular weight of air [kg/mole]
$M_{w,H2O}$	=	molecular weight of water [kg/mole]
$Q_{air,STP}$	=	air flow rate through the treatment zone as measured on a flowmeter calibrated to standard conditions (0 C and 1 atm) [L/min]
P	=	atmospheric pressure [atm]
$P_{v,w}$	=	vapor pressure of water [atm]
R	=	gas constant [0.0821 L-atm/mole-K]
t	=	time [min]
$T_{ambient}$	=	average ambient air temperature [C]
$T_{initial}$	=	initial temperature of soil in the treatment zone [C]
T_{ref}	=	reference temperature for energy calculations [0 C]
T_{soil}	=	temperature of soil in the treatment zone [C]
$\%RH_{ambient}$	=	percent relative humidity in ambient air [%]

5.8.4 HypeVent XSVE Use Instructions

HypeVent XSVE is a Microsoft Excel® file. It contains four worksheets identified by named tabs at the bottom of the HypeVent XSVE window (HypeVent XSVE Inputs & Calcs; Results – 1,4D Removal; Results – Soil T and Water; Flow Rate Estimates).

Project-specific information is input in worksheet “HypeVent XSVE Inputs & Calcs” shown below in Figure 5.8.3. Users enter numbers in the “Values” column for the ten rows with black text under the “Treatment Zone Characteristics” and “Operating Conditions” headings. Users can also choose to change some of the values under the “Physical-Chemical-Thermal Properties” section, although it is anticipated that most users will retain the values shown in Figure 5.8.3.

Cells formatted with **blue text** are calculation cells and should not be modified by the user. Users may want to save an original copy of the HypeVent XSVE file for use in case they accidentally modify any of the blue cells.

HypeVent XSVE for 1,4 Dioxane

PC Johnson 2014,2015,2016 (v1.3 July 2016)

Note: black =user inputs; blue= calculated values (do not change these cells)

Treatment Zone Characteristics	Values	Units	Notes
Soil Volume (V_{soil})	339600	L	$1 \text{ ft}^3 = 28.3 \text{ L}$
Initial 1,4-D Soil Concentration ($C_{soil,14D}$)	20	mg-1,4D/kg-soil	(from soil data)
Initial Soil Moisture (θ_m)	0.15	g-H ₂ O/g-soil	(max value is $<n/\rho_{soil}$, or saturated condition)
Total Soil Porosity (n)	0.4	L-pores/L-soil	(usually $0.3 < n < 0.5$ L-pores/L-soil)
Soil Bulk Density (ρ_{soil})	1.7	kg-soil/L-soil	(usually $1.5 < \rho_{soil} < 1.8$ kg-soil/L-soil)
Initial Temperature (T_{start})	20	C	(usually $15 < T_{start} < 25$ C)
Vapor-filled Porosity (θ_v)	0.145	L-vapor/L-soil	(should be >0 , or else θ_m is too large)
Soil Mass (M_{soil})	5.77E+05	kg-soil	($\rho_{soil} \times V_{soil}$)
Operating Conditions			
Ambient Temperature ($T_{ambient}$)	17	C	(use average outdoor air temperature)
Ambient Relative Humidity (%RH _{ambient})	58	%	(use average outdoor air relative humidity)
Treatment Zone Air Flowrate at STP ($Q_{air,STP}$)	2264	standard L/min	1 SCFM = 28.3 SLM (STP = 0 C, 1 atm)
Temperature that Injected Air Is Heated to (T_n)	120	C	
Treatment Zone Air Flowrate if Measured at $T_{ambient}$	2.40E+03	actual L/min	1 ACFM = 28.3 ALM
Treatment Zone Air Flowrate if Measured at T_n	3.26E+03	actual L/min	1 ACFM = 28.3 ALM
Air Mass Flow Rate Through Treatment Zone	2.83E+00	kg/min	(volumetric flowrate converted to mass/time)
Physical-Chemical-Thermal Properties			
Heat Capacity of Soil ($C_{p,soil}$)	0.8	kJ/kg-solid °C	Bristow (1998) [value for quartz]
Heat Capacity of Water ($C_{p,water}$)	4.2	kJ/kg-water °C	http://www.engineeringtoolbox.com
Heat Capacity of Air ($C_{p,air}$)	1	kJ/kg-air °C	http://www.engineeringtoolbox.com
Heat Capacity of Water Vapor ($C_{p,w,v}$)	1.84	kJ/kg-water-v °C	http://www.engineeringtoolbox.com
Enthalpy of Water Evaporation at 0 C ($\Delta H_{w,vap}$)	2257	kJ/kg-water	http://www.engineeringtoolbox.com
1,4-D Henry's Constant (H_i) at T_{start}	1.432E-04	L-H ₂ O/L-vapor	(based on Ondo and Dohnal (2007) equation)
Treatment Zone Mass Balance Quantities			
Initial Mass of 1,4-Dioxane in Soil	1.15E+01	kg-1,4-D	($\rho_{soil} \times V_{soil} \times C_{soil,14D}$)/1000
Initial Mass of Liquid Water In Soil	8.66E+04	kg-H ₂ O	($\rho_{soil} \times V_{soil} \times \theta_m$)*1000
Vapor Pressure of Water at T_{start}	2.30E-02	atm	(based on Yaws and Yang (1989) equation)
Initial Concentration of Water Vapor in Soil Pores	1.72E-02	g-H ₂ O/L-vapor	(based on Ideal Gas Law)
Initial Mass of Water Vapor in Soil Pores	8.47E-01	kg-H ₂ O	($C_{w,v,soil} \times V_{soil} \times \theta_v$)
Total Initial Mass of Water in the Soil	8.66E+04	kg-H ₂ O	(liquid water + water vapor)
Vapor Pressure of Water at $T_{ambient}$	1.90E-02	atm	(based on Yaws and Yang (1989) equation)
Concentration of Water Vapor in Ambient Air	8.35E-03	g-H ₂ O/L-vapor	(based on Ideal Gas Law and ambient %RH)
Mass Rate of Water Addition from Injected Air	2.01E-02	kg/min	(ambient water concentration x actual flow rate)
Energy Addition Rate from Injected Heated Air	3.95E+02	kJ/min	(ambient water concentration x actual flow rate)

Figure 5.8.3. Input Section of the HypeVent XSVE “HypeVent XSVE Inputs & Calcs”.

Most entries are self-explanatory. The soil volume is the target treatment zone soil volume, which can be approximated by a simple rectangular box shape calculation (e.g., enter “= 20 x 20 x 30 x 28.3” in the cell for a 20 ft long x 20 ft wide x 30 ft deep treatment zone volume in L units). Soil characteristics can be approximated if site-specific information is not available as suggested in the notes to the right of each quantity. Of those values, soil moisture may be the most critical to HypeVent XSVE application; and users are encouraged to collect site-specific information for that quantity or perform sensitivity analysis for a reasonable range of values.

Average ambient air conditions can be found through online weather data sources (e.g., <https://weatherspark.com/averages/stations/United%20States/California>).

The treatment zone vapor flow rate is entered as its equivalent value at “standard conditions” (0°C, 1 atm), which is common for vapor flow rate presentation in reports (e.g., SCFM).

The time-dependent mass balance equations occur in the columns to the right of the input cells in the “HypeVent XSVE Inputs & Calcs” worksheet. In the upper left corner of these columns is a black text user-specified input cell for “Time Step” as shown below in Figure 5.8.4.

The time step value entry is critical to the screening-level calculations. It is suggested that this value be selected so that: a) temperature changes between initial time steps are <5° C (third column below) and b) changes in total 1,4-dioxane mass are <10% of the initial value (sixth column below). This usually requires some iteration. Time steps larger than this may cause instabilities in the calculations (e.g., negative 1,4-dioxane or soil moisture values may appear) and time steps that are too small may result in calculations for time periods that are not as long as the period of interest.

(adjust the time step so that the temperature change between time steps is <5 C) and 1,4 dioxane mass change is <10%)

Time Step	10080	[min]						
Treatment Time [min]	Treatment Time [d]	Soil Temp T _{soil} [°C]	Normalized Soil Abs. Temp (T _{soil} /298.15)	Total Mass H ₂ O in Soil [kg-H ₂ O]	Total Mass 1,4-D in Soil [kg-1,4-D]	Vap Pres H ₂ O Soil at T _{soil} [atm]	Saturated H ₂ O Conc. in Soil Vapor at T _{soil} [g-H ₂ O/L-air]	Mass H ₂ O liquid in Soil [kg-H ₂ O]
0	0.00	2.000E+01	9.832E-01	8.66E+04	1.15E+01	0.0230	0.0172	8.66E+04
10080	7.00	2.296E+01	9.932E-01	8.638E+04	1.11E+01	0.0276	0.0204	8.64E+04
20160	14.00	2.559E+01	1.002E+00	8.608E+04	1.05E+01	0.0323	0.0237	8.61E+04
30240	21.00	2.789E+01	1.010E+00	8.569E+04	9.91E+00	0.0370	0.0269	8.57E+04

Figure 5.8.4. Time Step Entry Cell in “HypeVent XSVE Inputs & Calcs” Worksheet.

Two pre-formatted charts are found at the “Results – 1,4D Removal” and “Results – Soil T and Water” tabs; these present the projected 1,4-dioxane removal and removal rate estimates as shown in Figure 5.8.1 above and soil temperature and moisture changes with time as shown below in Figure 5.8.5. Users can modify the axes scales in these figures to best show their results.

The worksheet tab “Flow Rate Estimates” contains calculations that allow users to estimate vapor extraction flow rates for user-defined well construction (radius, length), soil characteristics (permeability), and operating conditions (vacuum). These calculations are not coupled to HypeVent XSVE performance predictions in the first worksheet so it does not have to be used to generate screening-level XSVE performance predictions. This worksheet is provided in case users are interested in estimating soil vapor flow rates for sites where they have yet to perform vapor extraction or injection pilot testing, or want to determine soil permeability from measured steady-state flow rate vs. vacuum pilot-test data.

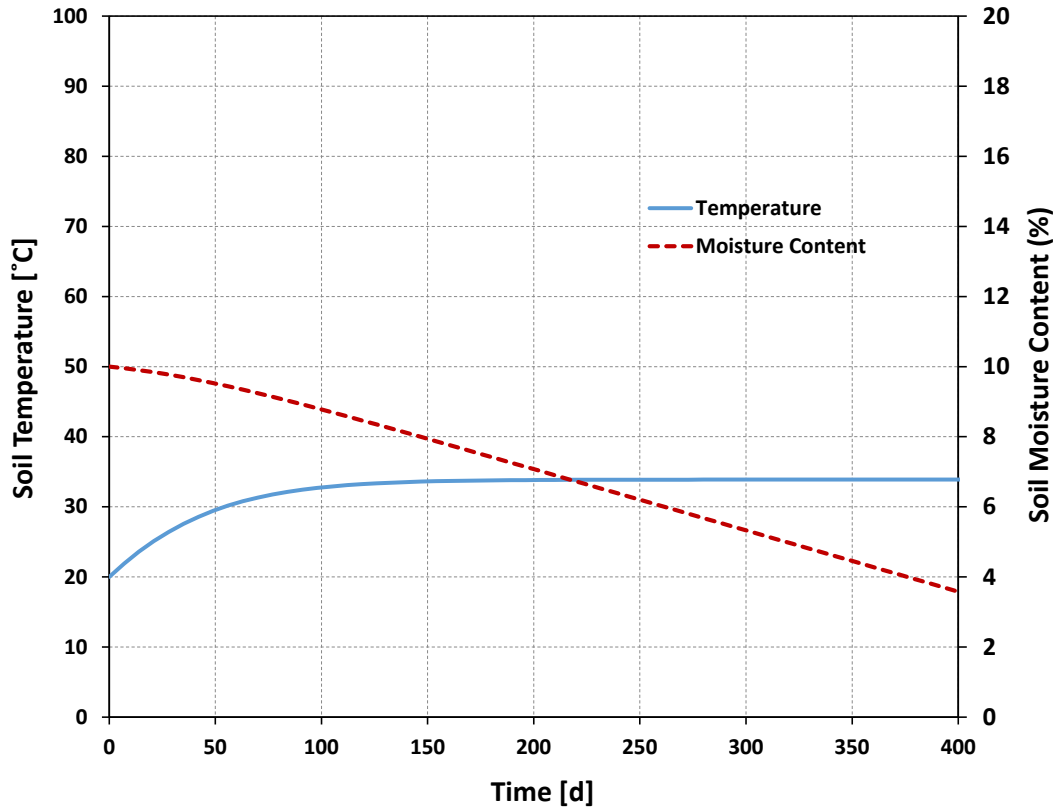

Figure 5.8.5. Sample HypeVent XSVE Output (“Results – Soil T and Water” chart).

5.8.5 Example HypeVent XSVE Application: Demonstration Site

This section illustrates use of HypeVent XSVE through application to this ESTCP project’s demonstration site conditions. HypeVent XSVE performance estimates are compared with demonstration project results.

Figure 5.8.6 shows the HypeVent XSVE input table with entries representative of demonstration site conditions. A brief explanation of each is given below:

- The XSVE demonstration test used four injection wells installed in a square pattern with 20 ft spacings and 30-ft screened intervals, so the treatment zone volume entered was 20 ft x 20 ft x 30 ft x 28.3 L/ft³ = 339,600 L.
- The initial 1,4-dioxane concentration (20 mg/kg-soil) was selected based on review of the pre-test soil concentration profile data presented in Figure 5.2.4. The post-test cumulative removal data presented in Figure 5.7.16 was also considered. For reference, an initial soil concentration value of about 23 mg/kg-soil is consistent with the 13 kg of 1,4-dioxane removed based on flow rate and extracted vapor concentration data.
- The initial soil moisture concentration (0.15 kg-H₂O/kg-soil) was selected based on review of the pre-test soil moisture profile data presented in Figure 5.2.5.

- The total soil porosity (0.4 L-pores/L-soil) and soil bulk density (1.7 kg-soil/L-soil) were not based on site data, but are reasonable generic values for soils at any site.
- The initial soil temperature (20°C) was selected based on the early time in situ temperature monitoring data presented in Figure 5.7.10.
- The average ambient air temperature (17°C) and relative humidity (58%) were selected based on review of historical weather data available online for Sacramento, CA (<http://www.sacramento.climatemps.com/humidity.php>).
- The treatment zone air flow rate (80 SCFM = 2264 SLM) was selected based on consideration that extraction vapor flow rates ranged from 70 to 110 SCFM during the test. The injection well data provided in Figure 5.7.7 were also reviewed with consideration that only 25% of the injected air would ideally flow into the target treatment zone from four injection wells placed on a square pattern.
- The injected air temperature (120°C) was selected based on review of the injection well temperature data presented in Figure 5.7.9.

HypeVent XSVE graphical results for Figure 5.8.6 inputs are presented in Figures 5.8.7, 5.8.8 and 5.8.9. The following is a summary of key observations from a comparison of HypeVent XSVE output and actual demonstration test performance data:

- HypeVent XSVE estimates 1,4-dioxane soil vapor concentrations that begin at about 20 mg/m³-vapor, increase to about 30 mg/m³-vapor, and then decrease as remediation proceeds. Site data presented in Figure 5.7.15 shows measured concentrations in the extraction well increasing from ~2 to a ~22 mg/m³-vapor before decreasing again down to about ~2 mg/m³-vapor. Soil gas data in Figure 5.7.14 show non-uniform vapors with a maximum concentration of almost 50 mg/m³-vapor. Thus, the HypeVent XSVE 1,4-dioxane soil vapor concentration estimates appear to be consistent with the demonstration test data.
- Predicted reductions in 1,4-dioxane mass in the treatment zone are consistent with demonstration test results. Figure 5.8.7 shows near-complete removal of 1,4-dioxane from soil within about 250 days; this compares well with the ~94% decrease in 1,4-dioxane mass within the treatment zone during the year-long demonstration, based on pre- and post-test soil concentration data (Figure 5.7.25).
- The maximum measured 1,4-dioxane removal rate of ~80 g/d in Figure 5.7.16 compares well with the predicted maximum rate of 107 g/d in Figure 5.8.7, and the shape of the removal rate vs. time curves are similar in both figures.
- There was an overall ~45% reduction in soil moisture in the demonstration test treatment zone (Figure 5.7.26) and this compares well with the predicted reduction of about 63% over 400 d shown in Figure 5.8.8.
- In the demonstration test, soil temperatures in the inner ring monitoring points (those closest to the extraction well, about 10 ft away) increased slowly and leveled-off at around 30 – 40°C (see Figure 5.7.10). This behavior is very similar to the HypeVent XSVE estimates shown in Figure 5.8.8.

- Soil temperatures at the deeper depths in outer ring monitoring points (those closest to the injection wells, about 10 ft away) were mostly similar to those at the inner ring monitoring points. The shallowest depth temperature histories were different, following similar trends for about the first 250 days, and then increasing more rapidly to about 90°C. This type of behavior is also anticipated by HypeVent XSVE calculations, but over longer time frames as shown in Figure 5.8.9. The transition from the lower temperature plateau to the near-injection temperatures occurs after all soil moisture is evaporated. Thus, a temperature history like that shown for VMW-4 (upper) in Figure 5.7.10 is indicative of soil drying out after about 250 days. In actual XSVE applications, soil drying will move outward from injection wells to extraction wells, so spatial variation in temperature histories is to be expected, in contrast to HypeVent XSVE calculations that assume simplified well-mixed soil conditions.

Overall, the performance anticipated by the HypeVent XSVE screening-level calculations is similar to that observed in the demonstration test. The difference is that removal occurs faster and to a greater extent in the screening-level calculations than in the actual demonstration test, but that is to be expected when using idealized best-case screening calculations.

XSVE HypeVent (customized for 1,4 Dioxane removal)

PC Johnson 2014,2015,2016 (v1.3 July 2016)

Note: black =user inputs; blue= calculated values (do not change these cells)

Treatment Zone Characteristics	Values	Units	Notes
Soil Volume (V_{soil})	339600	L	1 ft ³ = 28.3 L
Initial 1,4-D Soil Concentration ($C_{soil,14D}$)	20	mg-1,4D/kg-soil	(from soil data)
Initial Soil Moisture (θ_m)	0.15	g-H ₂ O/g-soil	(max value is $<n/\rho_{soil}$, or saturated condition)
Total Soil Porosity (n)	0.4	L-pores/L-soil	(usually $0.3 < n < 0.5$ L-pores/L-soil)
Soil Bulk Density (ρ_{soil})	1.7	kg-soil/L-soil	(usually $1.5 < \rho_{soil} < 1.8$ kg-soil/L-soil)
Initial Temperature (T_{start})	20	C	(usually $15 < T_{start} < 25$ C)
Vapor-filled Porosity (θ_v)	0.145	L-vapor/L-soil	(should be >0 , or else θ_m is too large)
Soil Mass (M_{soil})	5.77E+05	kg-soil	($\rho_{soil} \times V_{soil}$)
Operating Conditions			
Ambient Temperature ($T_{ambient}$)	17	C	(use average outdoor air temperature)
Ambient Relative Humidity (%RH _{ambient})	58	%	(use average outdoor air relative humidity)
Treatment Zone Air Flowrate at STP ($Q_{air,STP}$)	2264	standard L/min	1 SCFM = 28.3 SLM (STP = 0 C, 1 atm)
Temperature that Injected Air Is Heated to (T_m)	120	C	
Treatment Zone Air Flowrate if Measured at $T_{ambient}$	2.40E+03	actual L/min	1 ACFM = 28.3 ALM
Treatment Zone Air Flowrate if Measured at T_m	3.26E+03	actual L/min	1 ACFM = 28.3 ALM
Air Mass Flow Rate Through Treatment Zone	2.83E+00	kg/min	(volumetric flowrate converted to mass/time)
Physical-Chemical-Thermal Properties			
Heat Capacity of Soil ($C_{p,soil}$)	0.8	kJ/kg-solid °C	Bristow (1998) [value for quartz]
Heat Capacity of Water ($C_{p,water}$)	4.2	kJ/kg-water °C	http://www.engineeringtoolbox.com
Heat Capacity of Air ($C_{p,air}$)	1	kJ/kg-air °C	http://www.engineeringtoolbox.com
Heat Capacity of Water Vapor ($C_{p,wv}$)	1.84	kJ/kg-water-v °C	http://www.engineeringtoolbox.com
Enthalpy of Water Evaporation at 0 C ($\Delta H_{w,vap}$)	2257	kJ/kg-water	http://www.engineeringtoolbox.com
1,4-D Henry's Constant (H_i) at T_{start}	1.432E-04	L-H ₂ O/L-vapor	(based on Ondo and Dohnal (2007) equation)
Treatment Zone Mass Balance Quantities			
Initial Mass of 1,4-Dioxane in Soil	1.15E+01	kg-1,4-D	($\rho_{soil} \times V_{soil} \times C_{soil,14D}$)/1000
Initial Mass of Liquid Water In Soil	8.66E+04	kg-H ₂ O	($\rho_{soil} \times V_{soil} \times \theta_m$)*1000
Vapor Pressure of Water at T_{start}	2.30E-02	atm	(based on Yaws and Yang (1989) equation)
Initial Concentration of Water Vapor in Soil Pores	1.72E-02	g-H ₂ O/L-vapor	(based on Ideal Gas Law)
Initial Mass of Water Vapor in Soil Pores	8.47E-01	kg-H ₂ O	($C_{w,v,soil} \times V_{soil} \times \theta_v$)
Total Initial Mass of Water in the Soil	8.66E+04	kg-H ₂ O	(liquid water + water vapor)
Vapor Pressure of Water at $T_{ambient}$	1.90E-02	atm	(based on Yaws and Yang (1989) equation)
Concentration of Water Vapor in Ambient Air	8.35E-03	g-H ₂ O/L-vapor	(based on Ideal Gas Law and ambient %RH)
Mass Rate of Water Addition from Injected Air	2.01E-02	kg/min	(ambient water concentration x actual flow rate)
Energy Addition Rate from Injected Heated Air	3.95E+02	kJ/min	(ambient water concentration x actual flow rate)

Figure 5.8.6. HypeVent XSVE Inputs for the Demonstration Site Application Example.

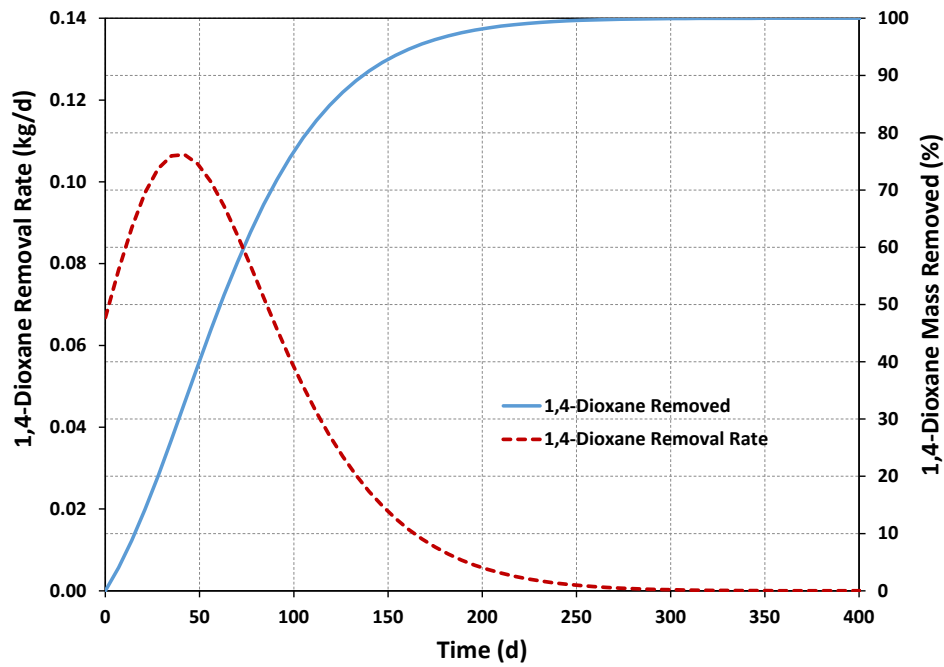

Figure 5.8.7. HypeVent XSVE 1,4-dioxane Removal Output for the Demonstration Site Application Example.

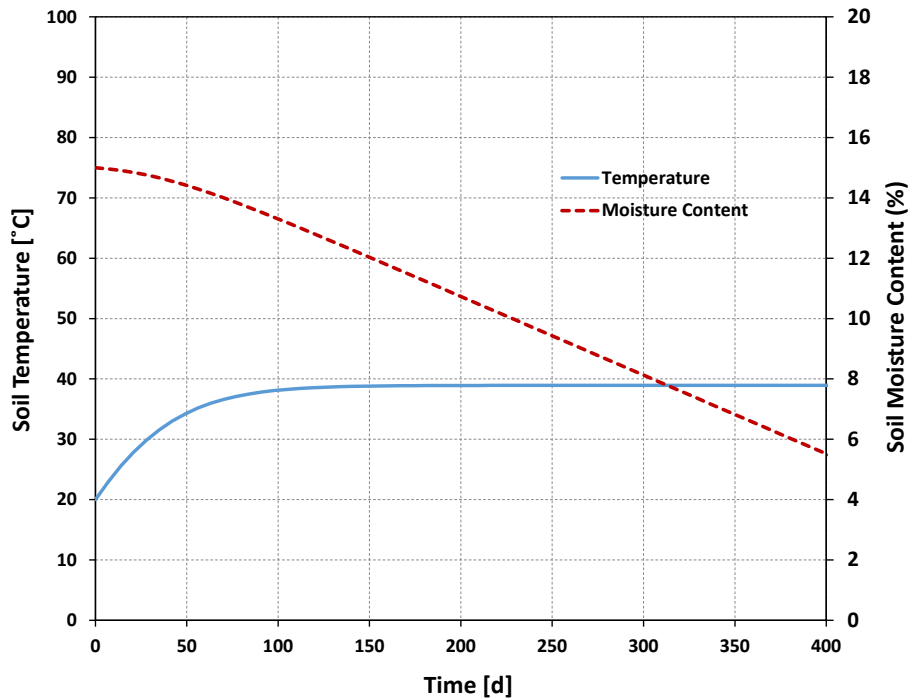

Figure 5.8.8. HypeVent XSVE Soil Temperature and Soil Moisture Output for the Demonstration Site Application Example.

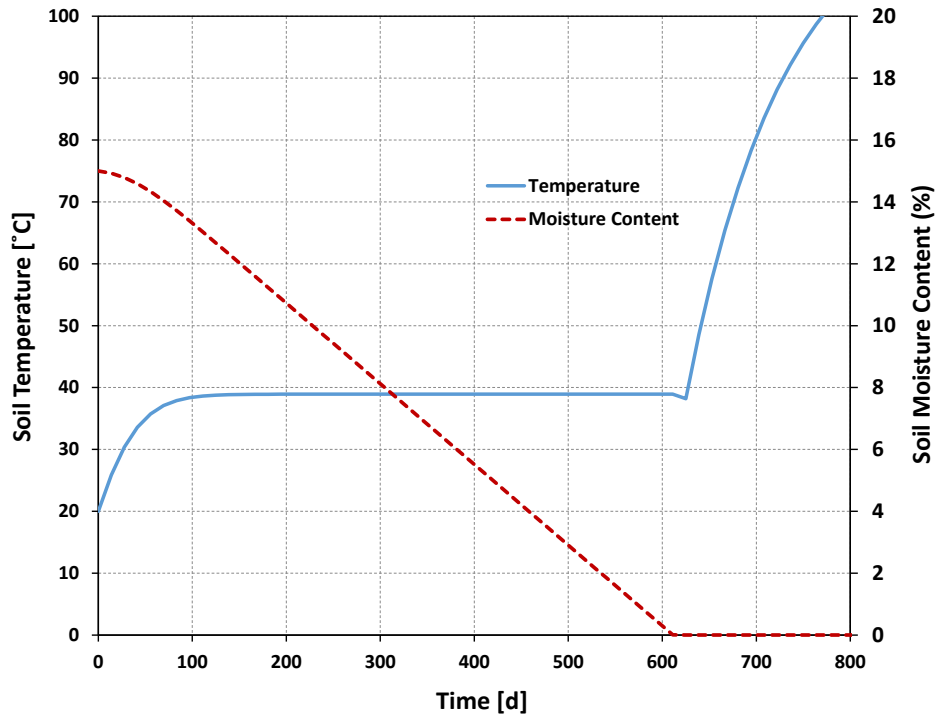

Figure 5.8.9. HypeVent XSVE Soil Temperature and Soil Moisture Output for the Demonstration Site Application Example, with Extended Timeline beyond Actual Test Duration to Illustrate the Inter-relationship Between Temperature History and Soil Drying.

5.8.6 HypeVent XSVE Application to Demonstration Site – Sensitivity Analysis

A series of HypeVent XSVE sensitivity analyses were conducted to examine the effect that different injection temperatures, soil moisture contents and ambient air relative humidity had on XSVE remediation performance. These sensitivity analyses were conducted using the demonstration site conditions except for the variables being examined.

The injection temperature sensitivity analyses used 17°C, 120°C, and 200°C injection temperatures. The first represents conventional SVE conditions with no heating, the second is the demonstration test condition, and the third is treatment with a more elevated injection temperature. Results are presented in Figures 5.8.10 and 5.8.11. Heated air injection accelerates remediation. For example, the demonstration test condition (120°C) achieves 80% 1,4-dioxane removal in about one-fourth the time as SVE with focused extraction (112 d for XSVE vs. 400 d for SVE) under ideal conditions. Increasing the injection temperature to 200°C decreases that time by about another 50% relative to 120°C air injection.

Soil moisture sensitivity analyses used demonstration conditions for soil moisture contents of 1, 5, 10 and 15%. The results are present in Figures 5.8.12 and 5.8.13. 1,4-Dioxane removal significantly improved with lower soil moistures. This is primarily due to higher 1,4-dioxane aqueous concentrations when there is less soil moisture. Also for low soil moisture levels the soils dry out significantly faster.

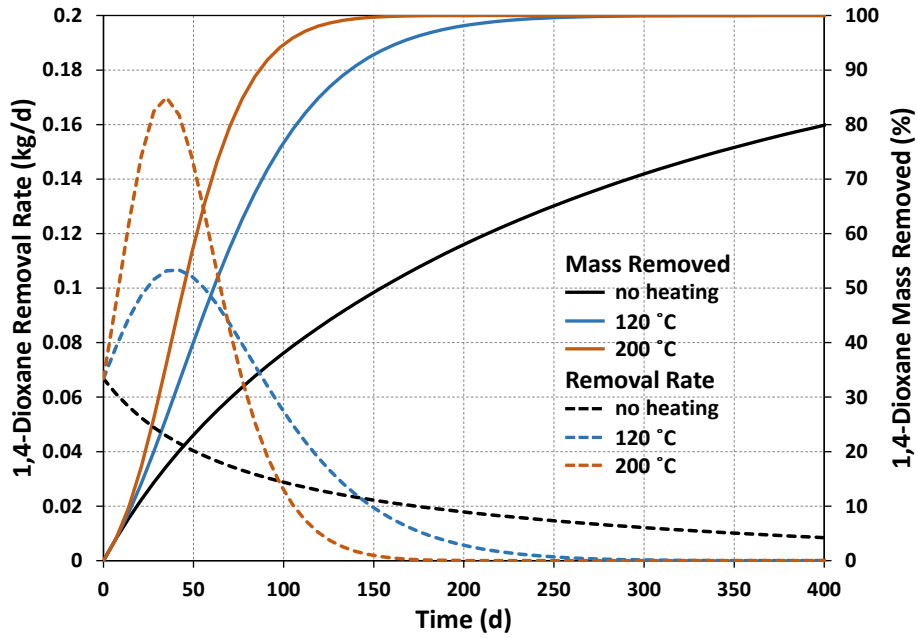

Figure 5.8.10. HypeVent XSVE 1,4-dioxane Removal Output for the Demonstration Site Application Example, for Three Different Heating Scenarios.

Note: Extraction for 400 days equates to ~10,000 pore volumes.

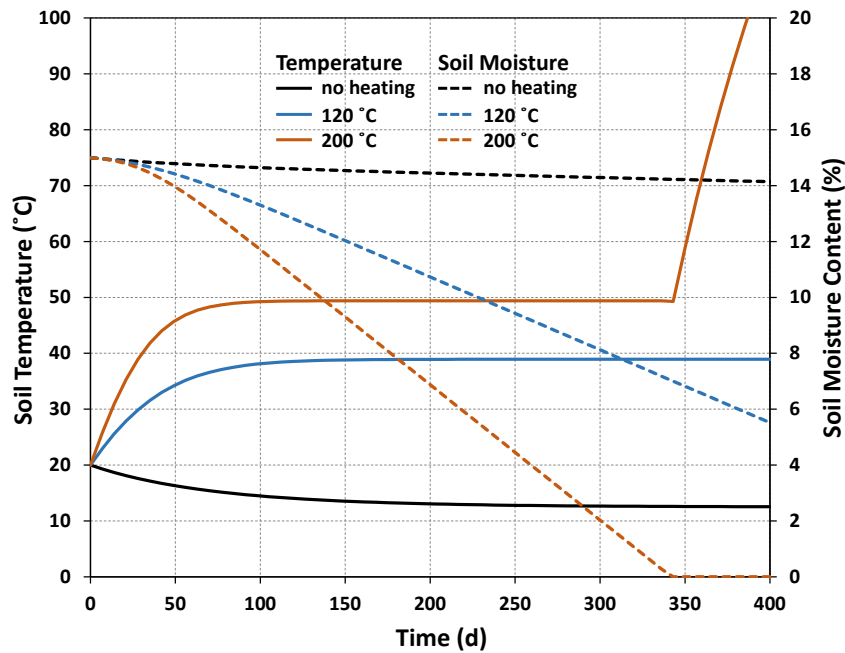

Figure 5.8.11. HypeVent XSVE Soil Temperature and Soil Moisture Output for the Demonstration Site Application Example, for Three Different Heating Scenarios.

Note: Extraction for 400 days equates to ~10,000 pore volumes.

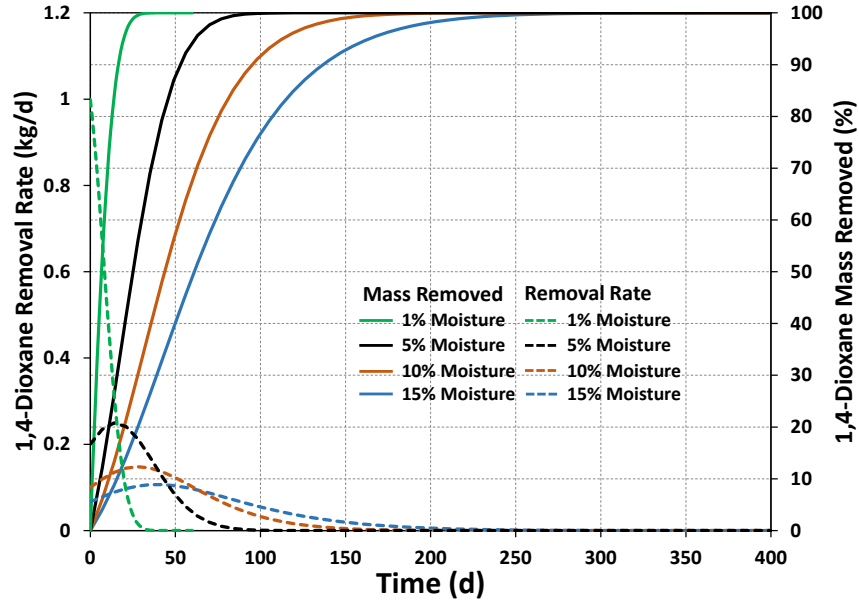

Figure 5.8.12. HypeVent XSVE 1,4-dioxane Removal Output for the Demonstration Site Application Example, for Three Different Soil Moisture Scenarios.

Note: Extraction for 400 days equates to ~10,000 pore volumes.

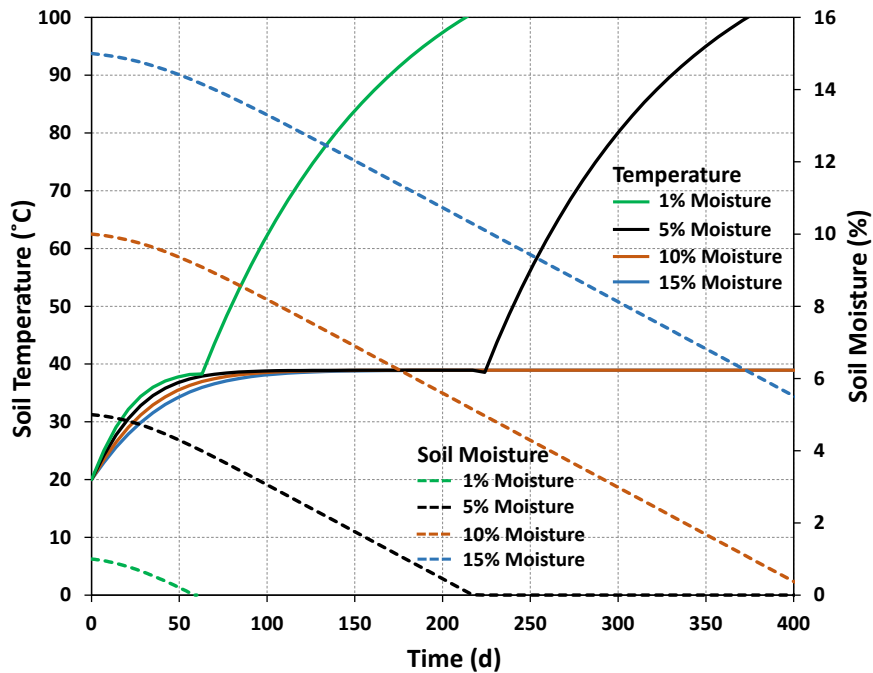

Figure 5.8.13. HypeVent XSVE Soil Temperature and Soil Moisture Output for the Demonstration Site Application Example, for Three Different Soil Moisture Scenarios.

Note: Extraction for 400 days equates to ~10,000 pore volumes.

HypeVent XSVE sensitivity analyses for demonstration conditions using different ambient air relative humidities (1, 50 and 100% RH) are shown in Figures 5.8.14 and 5.8.15. The results show relatively modest variations in 1,4-dioxane removal rates. The results indicate that soil temperatures stabilize at higher temperatures as the ambient air relative humidity increases. This is due to the greater energy input and less evaporative cooling with higher ambient air relative humidities. These results suggested that improvements in 1,4-dioxane removal rates could be gained if air at elevated temperatures with 100% RH were injected.

HypeVent XSVE sensitivity analyses for demonstration conditions using different injection temperatures (20, 40, 60 and 80°C) each with 100% RH are shown in Figures 5.8.16 and 5.8.17. The results show significant improvements in 1,4-dioxane removal as temperature increases, the highest rates observed of all of the sensitivity analyses. Soil temperatures reach the injection temperatures relatively quickly since there is no evaporative cooling since the injection air is already at 100% RH. As long as soil temperature is below the injection air temperature there is some condensation and soil moisture increases. The increase in soil moisture may be problematic if it causes downward migration of 1,4-dioxane in the condensate, thus caution should be used. The experimental column and 1-D modeling done in Section 5.9 below examines the validity of these results for heated air injections at 100% RH.

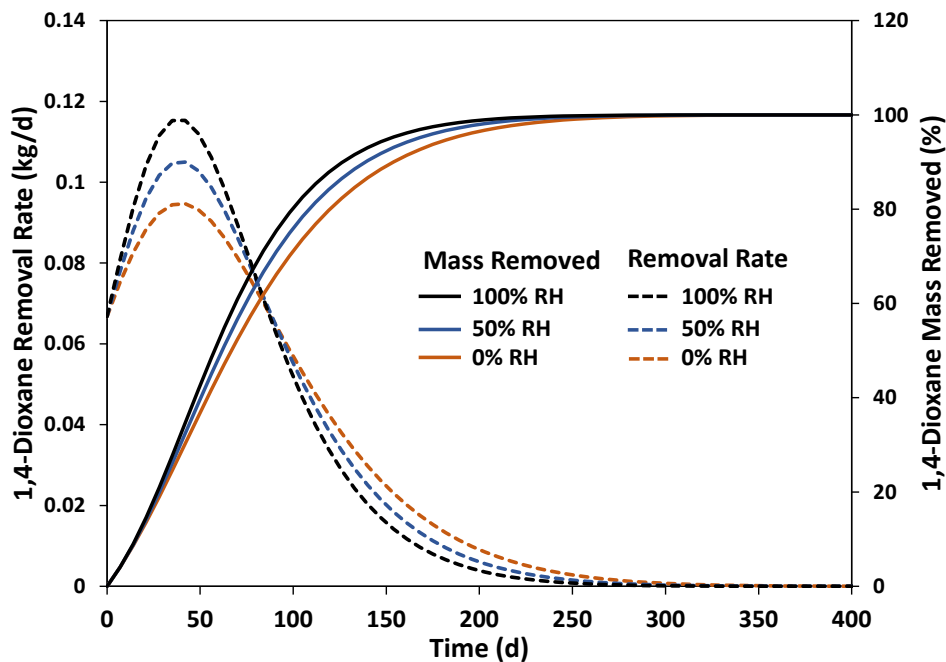

Figure 5.8.14. HypeVent XSVE 1,4-dioxane Removal Output for the Demonstration Site Application Example, for Three Different Ambient Air Relative Humidity Scenarios.

Note: Extraction for 400 days equates to ~10,000 pore volumes.

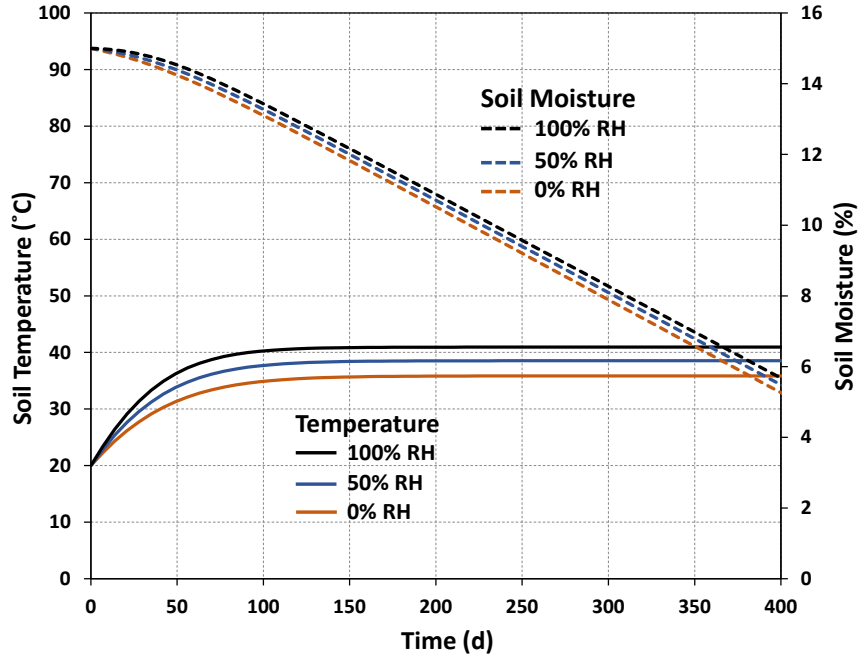

Figure 5.8.15. HypeVent XSVE Soil Temperature and Soil Moisture Output for the Demonstration Site Application Example, for Three Different Ambient Air Relative Humidity Scenarios.

Note: Extraction for 400 days equates to ~10,000 pore volumes.

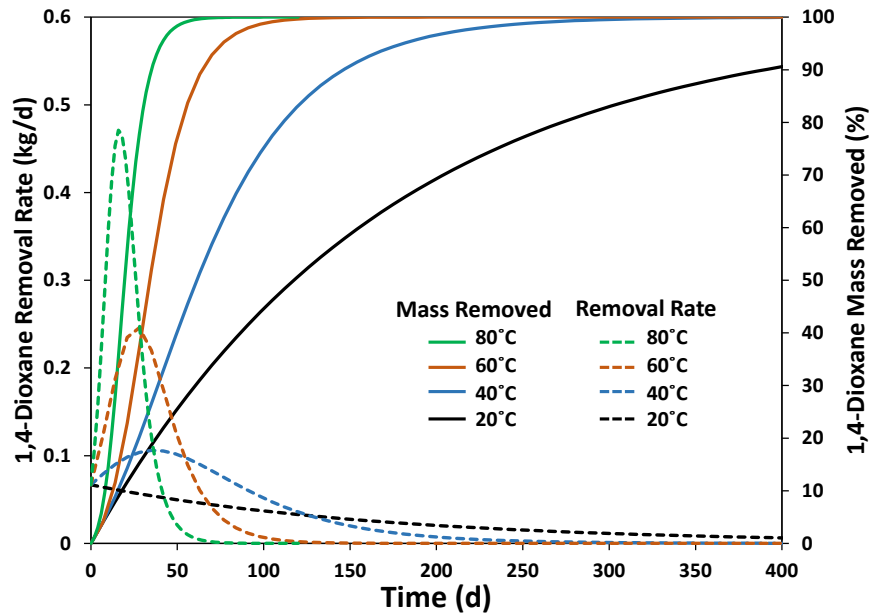

Figure 5.8.16. HypeVent XSVE 1,4-dioxane Removal Output for the Demonstration Site Application Example, for Four Different Injection Temperatures at 100% RH.

Note: Extraction for 400 days equates to ~10,000 pore volumes.

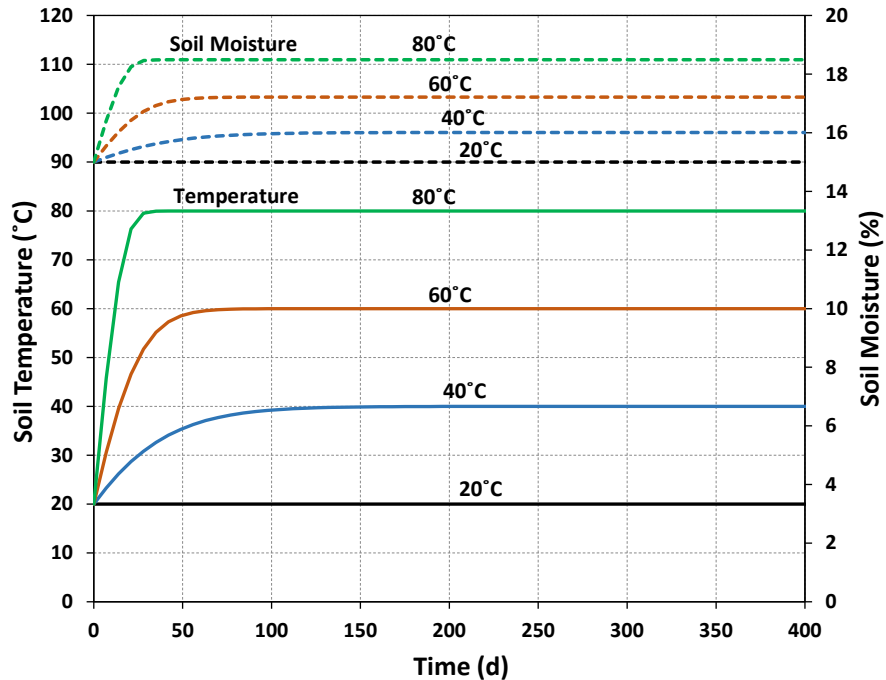

Figure 5.8.17. HypeVent XSVE Soil Temperature and Soil Moisture Output for the Demonstration Site Application Example, for Four Different Injection Temperatures at 100% RH.

Note: Extraction for 400 days equates to ~10,000 pore volumes.

5.9 1-DIMENSIONAL XSVE: EXPERIMENTAL AND MODEL RESULTS

Bench-scale column experiments of XSVE for 1,4-dioxane were conducted to gain a more comprehensive understanding of XSVE processes beyond the field demonstration conditions and to validate some HypeVent XSVE sensitivity analyses. HypeVent sensitivity analyses for injection air relative humidity (see Figures 5.8.14 to 5.8.17 and associated discussion) indicated that higher energy input due to higher relative humidity could substantially decrease 1,4-dioxane treatment times. Primary variables of interest in the column experiments were injected air temperature (22, 50 and 80°C) and relative humidity (100% RH at injection temperature and ambient air with 25% RH heated to injection temperature).

The bench-scale XSVE system was a 60 cm long, 15.24 cm diameter ABS (acrylonitrile butadiene styrene) column insulated with >15 cm of polystyrene insulation. Temperature and relative humidity conditioned clean air was injected from the bottom of the column at 2 L/min. Flow was controlled using a mass flow controller (Alicat Scientific). Two inline heating mechanisms (see Figures 5.9.1 and 5.9.2) were designed to test: 1) a heated 100% RH injection condition, and 2) a heated ambient air (25% RH) condition.

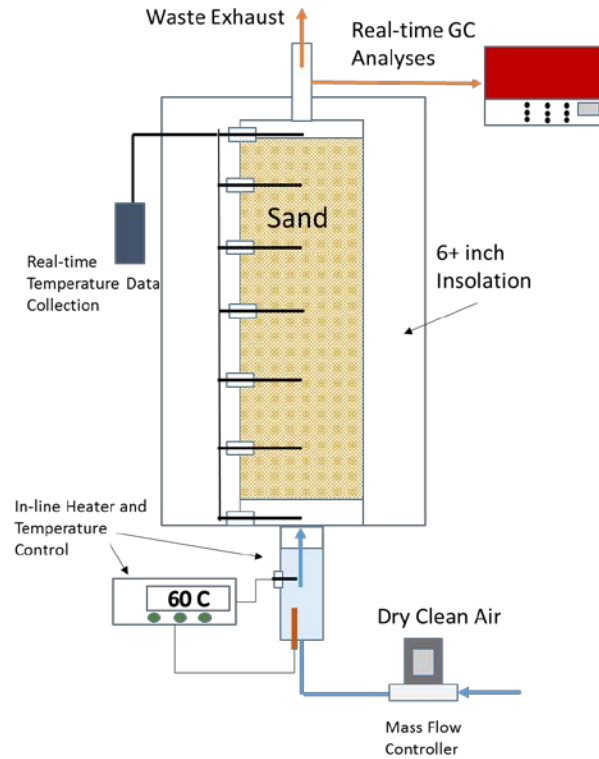

Figure 5.9.1. Schematic of Column Setup for Fully Humidified Air at Injection Temperature.

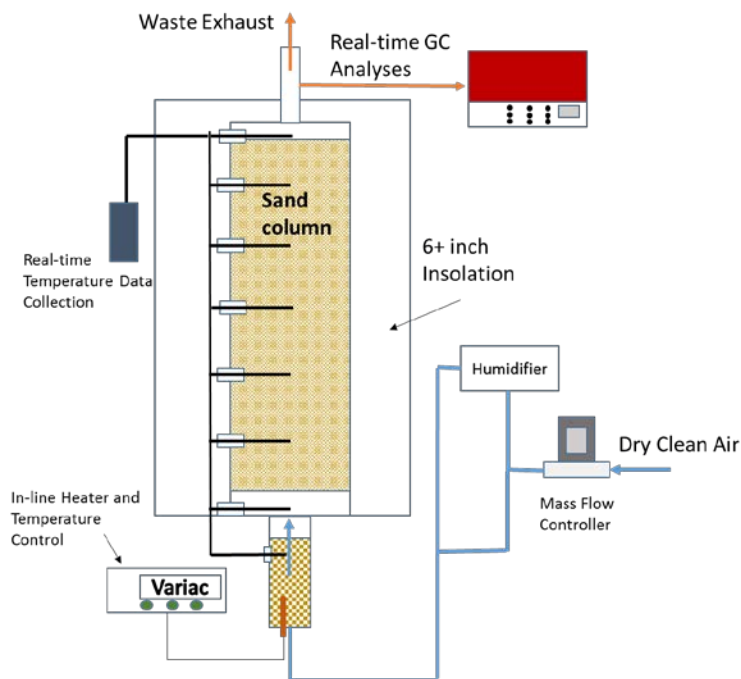

Figure 5.9.2. Schematic of Column Setup for Injection of Ambient Air (with specified RH) Heated to Injection Temperature.

Sand (60 mesh quartz) was mixed with an aqueous 1,4-dioxane solution to yield soils with the desired 1,4-dioxane and water concentrations for each test. The soil was placed in the column in packed lifts until full and the column was sealed. A heated water bath was used to humidify and heat air for the 100% RH injected air conditions. The water bath temperature was controlled using a heating element (Omega Engineering), an inline thermocouple (Pace Scientific), and a temperature-responsive PID controller (Omega Engineering). For the heated ambient air conditions, relative humidity was controlled using a bubble humidifier prior to heating. The humidified air stream was heated by an in-line heating element (Omega Engineering) with temperature being controlled by a Variac. Effluent gas phase samples were collected and analyzed every 12 minutes using a GC/FID (SRI Instruments) to determine 1,4-dioxane vapor concentrations. Soil temperatures were monitored at the inlet, 5 cm, 10 cm, 15 cm, 20 cm, 40 cm, 60 cm, and the outlet at 5-minute intervals using thermistors (Pace Scientific) and recorded using a data logger (XR5-SE, Pace Scientific).

Table 5.9.1 summarizes the experimental conditions tested. Injection air for tests 1, 2, 3 and 7 was humidified and heated using a water bath to ensure a RH of 100%. Injection air for tests 4, 5, and 6, on the other hand, was maintained at ~25 % RH before passing through a dry heating block to bring to injection temperature (i.e., similar to field XSVE demonstration where ambient air was heated before injection).

Table 5.9.1. Experimental Conditions for Bench-scale XSVE Column Tests.

Parameters	Units	Test 1	Test 2	Test 3	Test 4	Test 5	Test 6	Test 7
Injection air Temperature	°C	22	50	80	22	50	80	50
Injection air RH	%	100			25	4*	1*	100
Initial 1,4-dioxane Concentration	mg/kg	50						25
Initial soil moisture	g-H ₂ O/g-soil	0.05						
Air flow rate	L/min @ 22°C	2						

*Estimated injection air RH based on heating of ambient air (22°C; 25% RH) to injection temperature (<http://www.lennotech.com/calculators/humidity/relative-humidity.htm>).

Temperature results at the 5 and 40 cm locations for all column runs (except for 25 mg/kg 1,4-dioxane) are shown in Figure 5.9.3. The column temperature results show a temperature reduction (loss) as air moves up the column despite significant insulation of the column. The least temperature reduction occurred in the 80°C at 100% RH run, most likely due to a higher rate of energy input to the column. The 22°C 25% RH injection run shows a temperature drop in the soil column due to evaporative cooling. The 50°C and 80°C injection runs of heated ambient air (25% RH) do not reach injection temperatures due to evaporative cooling. The 5 cm location in the 80°C heated ambient air (25% RH) run between 500 and 1500 minutes show a decrease in what should be a stable plateau temperature, this is likely due to difficulties in maintaining the inlet temperature caused by the experimental design; after 1500 minutes the temperature increases due to the near total loss of soil moisture and subsequent decrease in evaporative cooling.

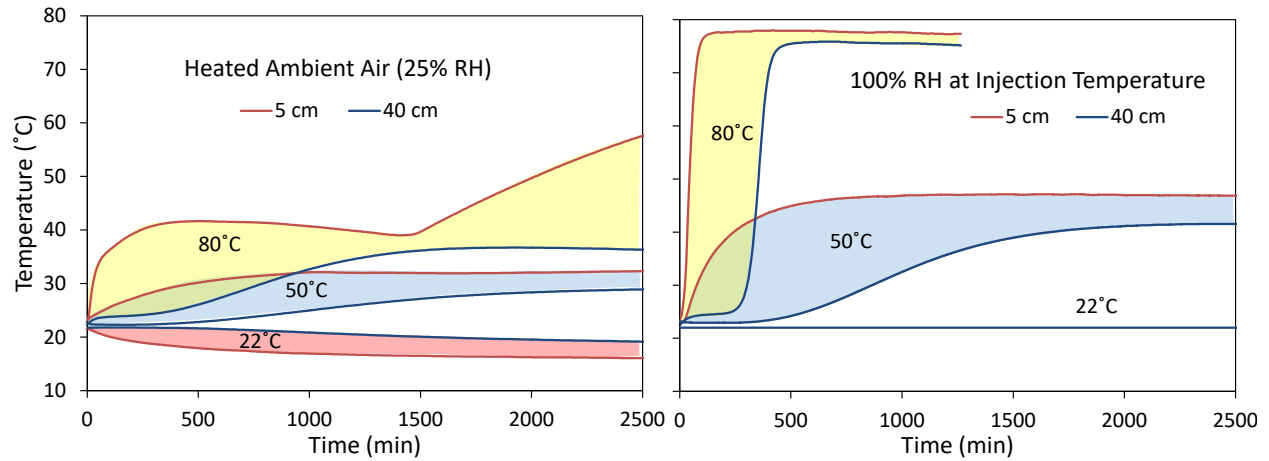

Figure 5.9.3. Temperature Profiles for Soil Temperatures at 5 cm (near inlet) and 40 cm (towards outlet) During Column Runs for Injections of Heated Ambient Air (25% RH) and 100% RH at Injection Temperature.

The column temperatures for the 22°C injection at 100% RH were assumed remain at room temperature (22°C) due to a lack of evaporative cooling.

Effluent 1,4-dioxane vapor concentration results for all column runs (except for 25 mg/kg 1,4-dioxane) are shown in Figure 5.9.4. The results show that elution concentrations were initially similar. Elution concentrations decreased in the 22°C 25% RH run due to the temperature drop caused by evaporative cooling. The 22°C 100% RH run effluent concentration remained nearly constant until 2000 minutes, after which concentrations fairly rapidly dropped. All other column runs show effluent concentrations increasing to a peak concentration followed by concentrations dropping to non-detect. The peak concentrations are earlier for the 100% RH runs at the same injection temperature. The peak maximum concentration was also highest for the 80°C 100% RH run.

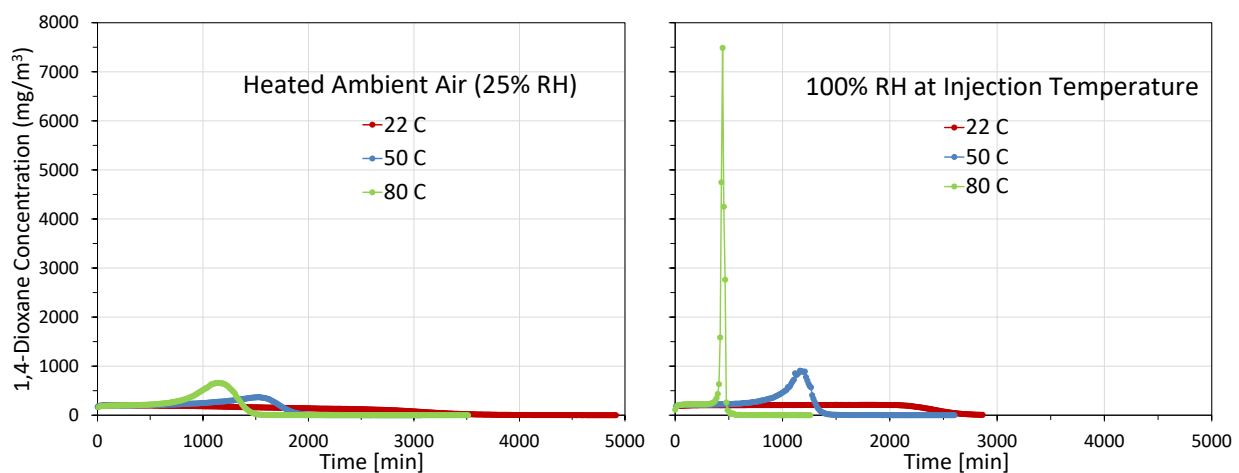

Figure 5.9.4. 1,4-Dioxane Elution Profiles During Column Runs for Injections of Heated Ambient Air (25% RH) and 100% RH at Injection Temperature.

The 1,4-dioxane removal rate was calculated by multiplying 1,4-dioxane concentration by the air flowrate (2 L/min). The % 1,4-dioxane removed was calculated using:

$$\% \text{ Removed}(t) = \frac{\int_0^t E_{14D}(t) dt}{\int_0^{t_0} E_{14D}(t) dt}$$

where $E_{14D}(t)$ is 1,4-dioxane remove rate [mg/min] as a function of time, and t_0 is the total time spent for effluent 1,4-dioxane concentration to reach non-detect. 1,4-Dioxane removal rate and % removal plots for XSVE column runs for injections of heated ambient air (25% RH) and 100% RH at injection temperature are given in Figures 5.9.5 and 5.9.6, respectively. Experimental data was compiled and analyzed using the above approach, and performance characteristics for each test are summarized in Table 5.9.2. Column runs with different soil 1,4-dioxane concentrations (25 and 50 mg/kg; both 50°C 100% RH) had similar treatment times to 95% removal, suggesting that soil concentration is a minor variable. Treatment time reductions relative to 22°C 25% RH run are given in Table 5.9.3.

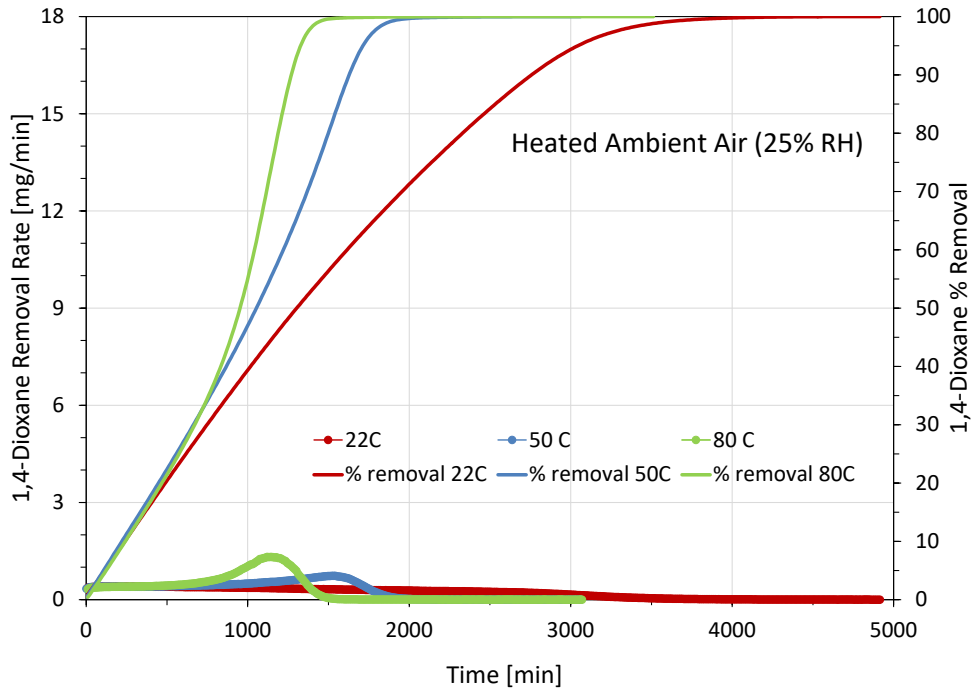

Figure 5.9.5. 1,4-Dioxane Removal Rates and % Removal for Column Runs for Heated Ambient Air (25% RH).

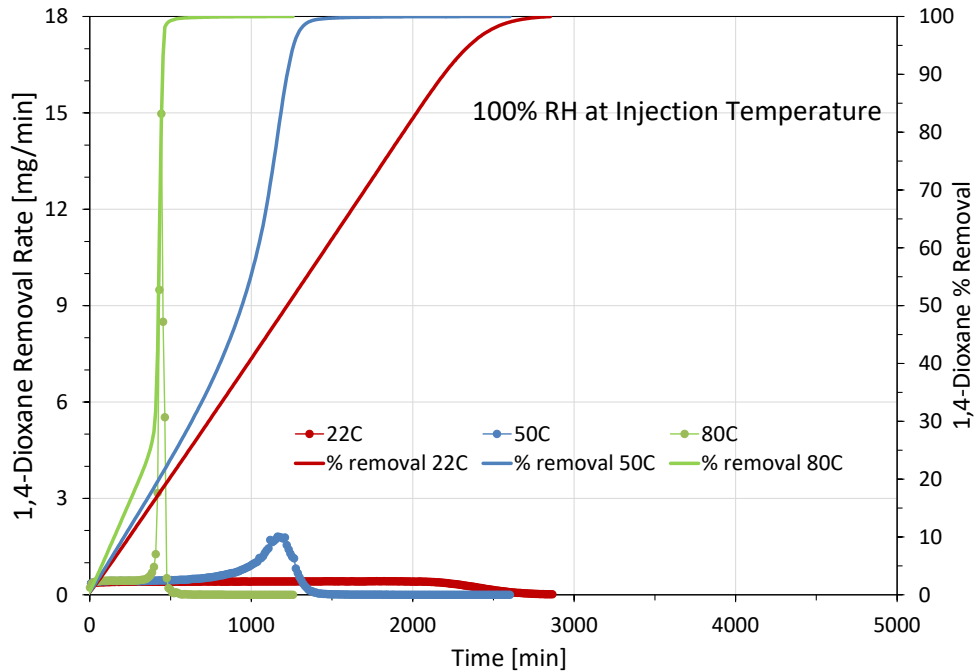

Figure 5.9.6. 1,4-Dioxane Removal Rates and % Removal for Column Runs for 100% RH at Injection Temperature.

Table 5.9.2. 1,4-Dioxane Treatment Performance Responses for Column Runs.

Response Item	Units	100% RH at Injection T			Heated Ambient Air ^b		
		22°C	50°C	80°C	22°C	50°C	80°C
Maximum Removal Rate	mg/min	0.4	1.8 (0.9) ^a	15.0	0.4	0.7	1.1
Time to 95% removal	min	2355	1264 (1177) ^a	460	3044	1712	1325

^a Values in parentheses are for initial 1,4-dioxane soil concentrations of 25 mg/kg as opposed to 50 mg/kg for all other runs.

^b Ambient air conditions were 22°C and 25% RH.

Table 5.9.3. Treatment Time Reductions (%) Relative to the 22°C 25% RH Column Run.

Temperature	Treatment Time Reduction	
	Heated Ambient Air (25% RH)	100% RH
22°C	0 % (reference condition)	23 %
50°C	44 %	59 %
80°C	56 %	85 %

HypeVent XSVE model is a screening-level energy and mass balance model of a mixed system rather than for a 1-dimensional column system. HypeVent XSVE results using the parameters of the experimental column system are shown in Figures 5.9.7 and 5.9.8. Although HypeVent is modeling for a simpler system, many of the general features of the experimental column results (see Figures 5.9.3 and 5.9.4) are in reasonable agreement with HypeVent XSVE. Injection of 100% RH air at injection temperature causes soil temperatures to increase and 1,4-dioxane to elute much more rapidly than for heated ambient air. Features of the 1-dimensional column and heat loss along the length of the column could not be captured with the screening-level HypeVent XSVE model. Additionally, the degree to which the assumption of local equilibrium was valid for the high flow rate used for the column runs (2 L/min) is not apparent.

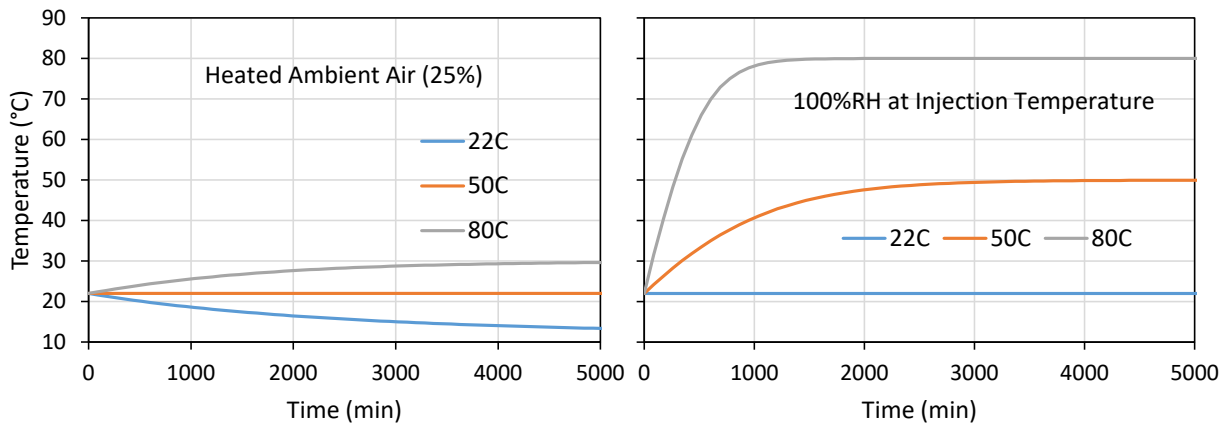

Figure 5.9.7. Temperature Profiles Generated by HypeVent XSVE Using Column Run Conditions for Injections of Heated Ambient Air (25% RH) and 100% RH at Injection Temperature.

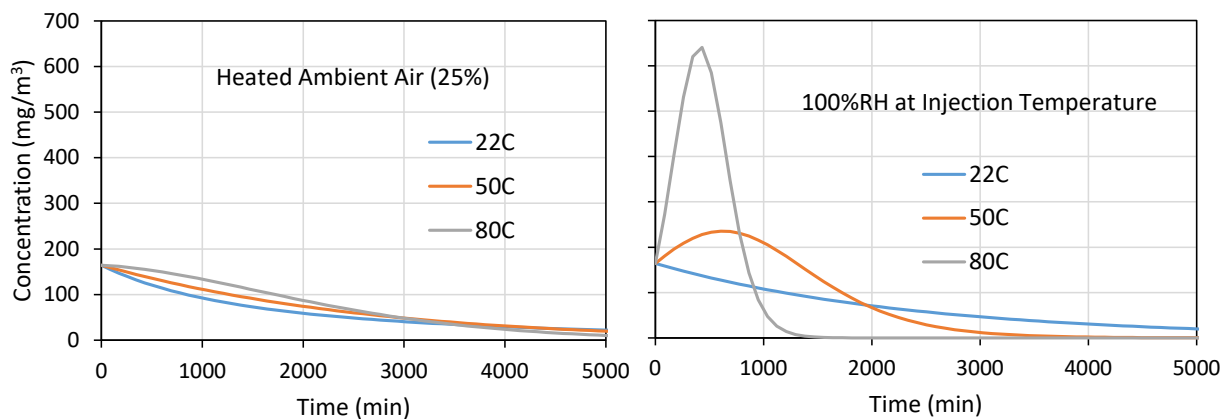

Figure 5.9.8. 1,4-Dioxane Concentration Profiles Generated by HypeVent XSVE Using Column Run Conditions for Injections of Heated Ambient Air (25% RH) and 100% RH at Injection Temperature.

A finite-difference numerical code was developed to simulate 1-D energy and mass transport during the XSVE process. This model was used to confirm soil temperature and 1,4-dioxane emissions behavior in the experimental column runs and assess the validity of assumption of local equilibrium. The model was based on similar fundamental principles as Hypevent XSVE, but was capable of performing transient heat and 1,4-dioxane transport simulations in greater detail. The model was also able to accommodate heat loss along the vapor flow path up the column. A numerical simulation of the column run is provided as confirmation of the observed emission behaviors during treatment. Modeling input parameters are summarized in Table 5.9.4 (50°C 100% RH conditions shown).

1-D model and experimental column soil temperature results for the 50°C 100% RH column run are shown in Figure 5.9.9. 1,4-Dioxane removal rate and % removed results for the experimental column and model (1-D and HypeVent XSVE) results are shown in Figures 5.9.10 and 5.9.11, respectively. There is good agreement between the 1-D finite difference model and experimental column results. This close agreement indicates that the local equilibrium assumption used by the 1-D model is valid and that the column results at high flow rates are transferable to a field situation that has lower flow rates. Elution profiles indicate that 1,4-dioxane should concentrate in the soil vadose water in the cooler distal end of the column. The 1-D model was used to simulate 1,4-dioxane soil concentrations at various times; results shown in Figure 5.9.12. The simulated results shows a front of increased 1,4-dioxane soil concentrations moves through the soil column over time.

Table 5.9.4. Input Parameters Used to Simulate Bench Scale XSVE 50°C 100% RH Column Run.

Treatment Zone Characteristics	Values	Units
Soil Column length	60	cm
Soil Column Cross-section Area	177	cm ²
Initial 1,4-D Soil Concentration	50.3	mg-1,4D/kg-soil
Initial Soil Moisture	0.05	g-H ₂ O/g-soil
Total Soil Porosity	0.4	L-pores/L-soil
Soil Bulk Density	1.6	kg-soil/L-soil
Initial Temperature	22	°C
Operating Conditions		
Injection Air Temperature	50	°C
Injection Air Relative Humidity	100	%
Treatment Zone Air Flowrate at STP	2	standard L/min
Physical-Chemical-Thermal Properties		
Heat Capacity of Soil	0.8	kJ/kg-solid °C
Heat Capacity of Water	4.2	kJ/kg-water °C
Heat Capacity of Air	1	kJ/kg-air °C
Heat Capacity of Water Vapor	1.84	kJ/kg-water °C
Enthalpy of Water Evaporation at 0 °C	2257	kJ/kg-water
Thermal Conductivity of Soil	1	W/m-K
Energy Lost along Column*	0.06	J/cm/°C/min

* Heat lost estimated based on soil temperature profiles.

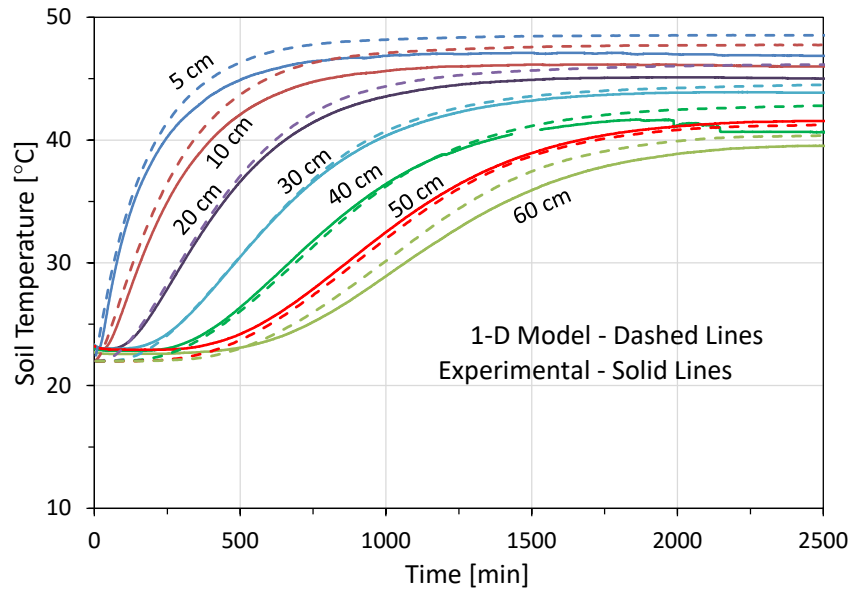

Figure 5.9.9. Experimental Column (solid) and Simulated (dashed) Soil Temperatures at Seven Heights along Soil Column for 50°C 100% RH Column Run.

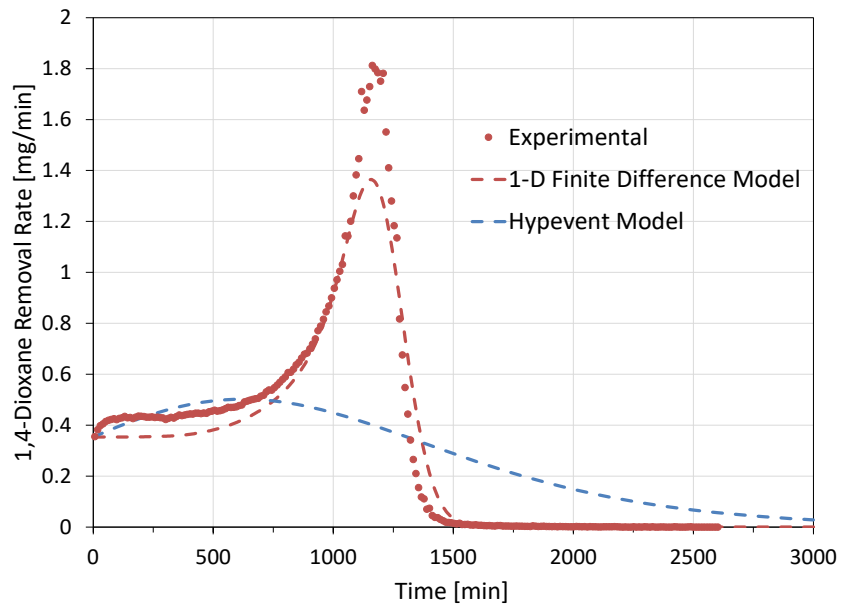

Figure 5.9.10. Experimental Column and Simulated 1,4-dioxane Removal Rates (HypeVent XSVE and 1-D models) for the 50°C 100% RH Column Run.

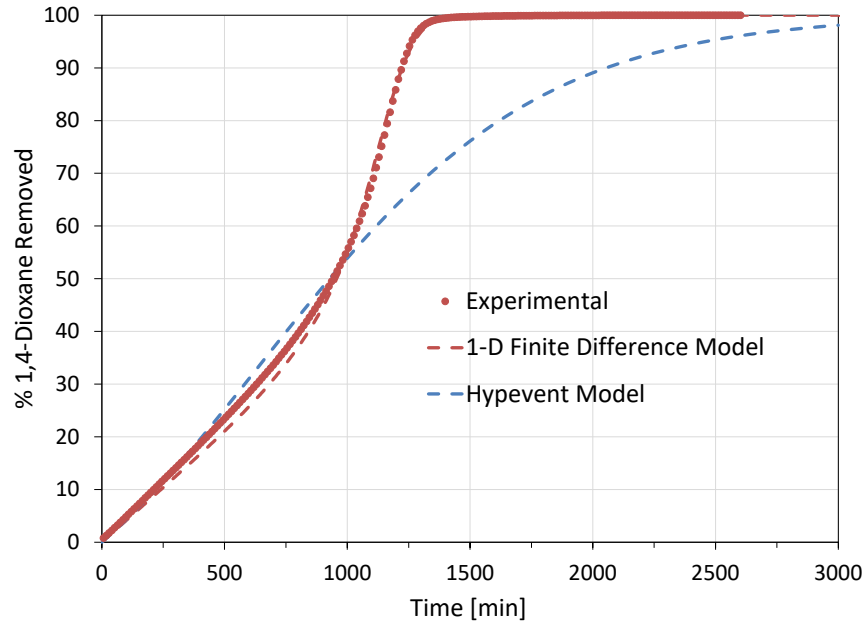

Figure 5.9.11. Experimental Column and Simulated % 1,4-dioxane Removed (HypeVent and 1-D models) for the 50°C 100% RH Column Run.

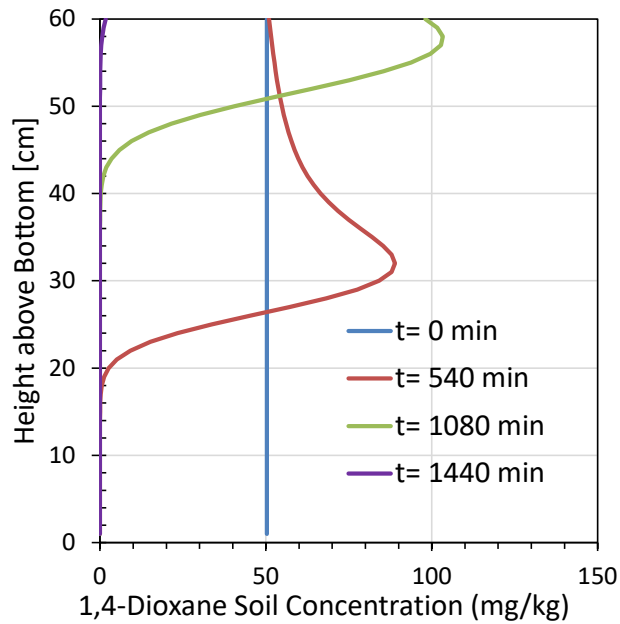

Figure 5.9.12. 1-D finite Difference Model Simulations of 1,4-dioxane Soil Concentration (mg/kg) Profiles at Different Times during the 50°C 100% RH Column Run.

Page Intentionally Left Blank

6.0 PERFORMANCE ASSESSMENT

6.1 QUANTITATIVE: REDUCTION IN SOIL 1,4-DIOXANE

The primary performance metric for this project is whether sufficient 1,4-dioxane is removed from the vadose zone so that it no longer serves as a source of groundwater contamination. The performance goal for this metric was to remove at least 90% of the 1,4-dioxane present in the treatment zone. The pre- and post-demonstration soil results showed a ~94% reduction in 1,4-dioxane, so this performance metric was reached. The ~5% remaining in the soil should result in a substantially reduced flux of 1,4-dioxane to groundwater.

A relevant question is whether heating was required to remove 1,4-dioxane or whether it would have been removed using focused SVE alone. The HypeVent XSVE model results shown in Figure 5.8.10 examines this question and shows that heated air injection significantly decreases remediation time compared to focused SVE alone (ambient temperature injection).

6.2 QUANTITATIVE: MINIMIZATION OF 1,4-DIOXANE DOWNWARD MIGRATION

Injection of heated air helps to volatilize water so that it can be removed, but before it reaches the extraction well water vapor could be re-condensed. 1,4-Dioxane could also be present in the re-condensed water. If sufficient volume of water was re-condensed it could saturate the vadose zone and migrate downward below the treatment zone and continue to serve as source of groundwater contamination. The performance goal for this metric was for 1,4-dioxane concentrations beneath the treatment zone to not increase more than 20% over initial conditions. The pre- and post-demonstration soil results showed a decrease in 1,4-dioxane concentrations beneath the treatment zone (see Figure 5.7.25), so this performance metric was reached. The soil moisture results suggest that some condensation did occur in the Inner Ring, however it does appear to have caused any increase in 1,4-dioxane beneath the treatment zone.

6.3 QUALITATIVE: ADEQUATE SOIL GAS 1,4-DIOXANE MEASUREMENTS AT ELEVATED TEMPERATURES

The vapor/condensate sampling apparatus and the resulting analyses of the vapor and condensate phases provided dependable soil gas 1,4-dioxane measurements at elevated temperatures. The use of the vapor/condensate sampling apparatus provide a more reliable measure of 1,4-dioxane in soil gas at elevated temperatures than direct vapor canister sampling. At times, direct vapor canister sampling at the extraction wellhead resulted in low values for unknown reasons. Direct vapor canister sampling after the AWS provided values that were reasonably consistent with those obtained with the vapor/condensate apparatus.

6.4 QUALITATIVE: EASE OF XSVE SYSTEM INSTALLATION AND STARTUP

The XSVE system was only moderately more complex to install than a traditional SVE system. Most SVE systems do not use injection wells, however injection wells are not complicated to install. The in-line heaters and materials used to construct they system were the main concerns during the design stage. The only difficulty encountered was the melting of PVC piping adjacent to the in-line heater. After replacement steel piping was installed just before the in-line heaters, there were no further difficulties.

6.5 QUALITATIVE: EASE OF XSVE SYSTEM OPERATION AND MONITORING

Operation of the XSVE system was robust with a ~99% uptime after the first two weeks of operation. System monitoring was generally no more complex than done for most SVE operations where flows and pressures are routinely monitored. Temperature measurements are straightforward.

6.6 QUALITATIVE: UPDATED HYPEVENT AS A USEFUL TOOL IN XSVE SYSTEM DESIGN AND IMPLEMENTATION

HypeVent XSVE is a screening-level tool created to assist in system design and data reduction and to anticipate how XSVE operating conditions affect XSVE performance (e.g., cleanup level, remediation time, etc.). It is an energy and mass balance (water and 1,4-dioxane) model that assumes well-mixed conditions. Although it makes simplifying assumptions, HypeVent XSVE was able to adequately anticipate the field demonstration results. It was used to predict XSVE system performance under differing conditions of air injection temperature, injection relative humidity and soil moisture. HypeVent XSVE results for elevated temperature injections at 100% relative humidity were confirmed with laboratory column experiments. HypeVent XSVE is a useful tool for XSVE system design and implementation.

7.0 COST ASSESSMENT

7.1 COST MODEL

Costs associated with various aspects of the demonstration were tracked throughout the course of the project in order to evaluate the cost of a potential full-scale XSVE and compare it against other remedial approaches. Table 7.1.1 summarizes the various cost elements and total cost of the demonstration project. Many of the costs shown on this table are a product of the research nature of this project, and would not be incurred in a routine full scale implementation of XSVE. A separate column assumes the cost for a more routine application. The total cost of the demonstration was \$1,340,000, which included \$534,000 in capital costs, \$314,000 in operations and maintenance (O&M) costs, and \$492,000 in other costs primarily related to ESTCP requirements, site selection, and specialized characterization. The estimated cost to have implemented this technology on a more routine basis at this same scale on this same site is \$450,000. The actual cost of routine implement will vary considerably from site to site, the unit cost in terms of cubic meters treated will go down on most sites, as this demonstration was relatively small in scale.

Table 7.1.1. Cost Model for XSVE.

Element	Demonstration, actual	Routine Application, estimated
Capital Costs		
System Design	\$192,000	\$84,000
Well Installation	\$204,000	\$94,000
System Installation	\$138,000	\$101,000
Subtotal	\$534,000	\$279,000
Operation and Maintenance Costs		
Power	\$26,000	\$18,000
Labor and Travel	\$227,000	\$87,000
Materials	\$29,000	\$12,000
Analytical Cost	\$32,000	\$16,000
Subtotal	\$314,000	\$133,000
Other Costs		
HypeVent model development	\$128,000	\$0
Site Selection	\$48,000	\$0
Demonstration Plan	\$49,000	\$0
Bench and Lab Testing	\$148,000	\$0
Site Characterization, specialized		
Labor	\$92,200	\$0
Materials	\$13,400	\$0
Drilling Contractor (post sampling)	\$84,000	\$0
PneuLog	\$24,000	\$0
Analytical Cost (pre and post)	\$76,200	\$0
Well destruction and liner repair	\$37,800	\$18,000
Final Report	\$96,000	\$20,000
Cost and Performance Report	\$16,000	\$0
Technology Transfer	\$158,000	\$0
Subtotal	\$492,000	\$38,000
Total	\$1,340,000	\$450,000

7.1.1 Capital Costs

Capital costs (primarily system design and installation) accounted for \$534,000, or about 39% of the total cost. These costs considerably exceeded what would be expected to be incurred in a routine application of the technology. The primary savings would be in a much easier design and a reduction in monitoring well installation. The HypeVent XSVE model is now available making design calculations much more straight forward. The 4 highly instrumented VMW monitoring wells would be unnecessary. Additionally, though not reflected here, well spacing would likely be wider allowing treatment of a greater volume of soil lowering unit costs.

7.1.2 Operations & Maintenance Costs

O&M accounted for \$314,000 or about 23% of the total demonstration cost. It is anticipated that lower O&M costs would be incurred in a routine application. Power costs should be lower as excess heated air was injected in the demonstration to insure all capture air had been heated, this should not be necessary in a routine application. The largest O&M savings in a routine application would be lower labor and travel cost. Substantially less monitoring and system optimization should be required, and local labor should suffice. There would also be lower analytical costs.

7.1.3 Demonstration Specific Costs

In addition to the specialized demonstration costs described above other elements of an ESTCP project would not be expected to be incurred in a routine application. Soil sampling would be at a much lower density, and there would not be the need for the laboratory testing, HypeVent XSVE model development, technology transfer or other ESTCP-related costs.

7.2 COST DRIVERS

7.2.1 General Considerations

Many factors will impact the potential cost of XSVE implementation and its cost relative to competing technologies. These cost drivers are detailed in Table 7.2.1. Note that comparisons to conventional SVE are made as it is a well-developed and understood technology closely related to XSVE. Existing or planned conventional SVE would likely exist at most sites where XSVE would be applicable.

Table 7.2.1. Cost Drivers to Consider for XSVE.

Cost Drivers	Considerations
Volume of Soil to be Treated	<ul style="list-style-type: none"> Depth, surface area, concentrations. Generally larger treatment volumes will have a lower unit cost, deeper treatment will be more cost competitive than shallow.
Preexisting SVE Infrastructure	<ul style="list-style-type: none"> Preexisting or planned SVE infrastructure would be common at most XSVE candidate sites to treat VOCs. Usable infrastructure in good condition will lower XSVE costs.
Site Geology	<ul style="list-style-type: none"> Large volumes of air must be moved for effective XSVE therefore the technology will be more cost effective at higher permeability sites. Application to dryer vadose zone conditions will also lower cost.
Presence of Other Contaminants	<ul style="list-style-type: none"> Most common VOCs will also be extracted, potentially increasing treatment costs.
Site Characterization	<ul style="list-style-type: none"> Site characterization may be costlier than for conventional SVE. Due to the high number of pore volumes of soil requiring extraction by XSVE more precise identification of source zone soils is required than is the case for SVE for VOCs.
Installation	<ul style="list-style-type: none"> Costs are similar to SVE, except well materials and construction must account for the increased temperature if heated air injection is used.
Operation and Maintenance Costs	<ul style="list-style-type: none"> Similar to SVE except for heated air injection which will require energy cost and may increase the need for site security and oversight. Air Treatment (if required) of 1,4-dioxane is possible using conventional SVE equipment such as activated carbon or thermal treatment. Analysis costs are also similar to SVE since 1,4-dioxane can be included in routine TO-15 analysis.

7.2.2 Competing Treatment Technologies

At present, there are few competing technologies for 1,4-dioxane treatment in vadose zone soils. The authors are aware of no full-scale treatments to date. It may be possible to 1,4-dioxane contaminated vadose zone soil in situ using bioremediation, chemical oxidation, or soil flushing. However, to our knowledge, these technologies have not yet been attempted and there are technical challenges to overcome before they could be applied. Excavation is the only developed proven competitor to XSVE, and two excavation approaches will be compared to XSVE in the cost analysis below.

7.3 COST ANALYSIS

In this cost analysis, XSVE will be compared with traditional excavation and large diameter auger excavation. For the purposes of this analysis a hypothetical site (Section 7.3.1 Base Case) with characteristics generally similar to the former McClellan AFB OU-D XSVE demonstration site will be used. This should not be considered to in anyway describe actual full site conditions at OU-D. Cost estimates for the XSVE technology are based on this demonstration. Cost estimates for the excavation technologies are based on USEPA (2000) guidance for traditional excavation and DOE (2009) for the large diameter auger excavation. Cost comparisons are given in Table 7.3.1.

Table 7.3.1. Cost Comparison between XSVE and Competing Technologies.

Technology	Cost	Treatment Efficiency	Timeframe
XSVE	\$450,000	94%	18 months
Traditional Excavation	\$3,400,000	100%	12 months
Excavation using Large Diameter Auger	\$760,000	75%	12 months

For the hypothetical site situation and assumptions described below, XSVE appears to be the most cost-effective approach. The reader is cautioned that actual costs will vary considerably from site to site, and it cannot be assumed XSVE will always be the most cost-effective approach. The conclusion here is that XSVE is likely to be a competitive technology in terms of cost, treatment efficiency and remediation timeframe at many sites.

A comparison to conventional SVE is not presented as we do not believe that a conventionally operated SVE without heating to be a practical process for 1,4-dioxane removal. As shown in Figures 5.8.10 and 5.8.11 the HypeVent simulation shows that removal without heating would result in substantially lower rates of 1,4-dioxane removal. After removal of ~10,000 pore volumes of air, far more than are typically removed by conventional SVE, only 80% removal is predicted, in practice this would likely be less. An important result of air injection without heating or humidification is the lowering of soil temperatures due to evaporative cooling. This lowering of soil temperature will lower the Henry's constant and slow 1,4-dioxane removal. The McClellan site where this demonstration was performed is clear evidence of the inefficiency of conventional SVE. The location where this demonstration was performed had been subject to conventional SVE for about 20 years before the demonstration, and yet significant 1,4-dioxane remained in the soil. XSVE removed ~95% of this 1,4-dioxane in about a single year.

7.3.1 Base Case

The hypothetical base case for this analysis has the following characteristics:

- 20 ft x 20 ft area requiring treatment
- 38 ft to 68 ft below land surface, overlain by capped sanitary landfill
- Silty/clayey sand with 10% soil moisture
- For the XSVE application it is assumed that an operating SVE system exists and that costs will only be the incremental cost of XSVE application, new XSVE wells and piping, necessary upgrades to the air treatment system, and XSVE-related O&M costs including power.
- For XSVE 5 new wells will be installed and connected, 4 injection wells, 1 extraction well.

This is realistic as it is based on the McClellan field demonstration experience. It is important to note that XSVE for 1,4-dioxane will typically involve a much smaller soil volume than typical VOC remediation. This is due to the tendency of VOCs to spread due to vapor transport to volumes much greater than the volume of soil with historic NAPL contact. It is the author's experience that the 1,4-dioxane (vadose zone) contaminated soil volume is typically limited to areas of initial direct NAPL contact where 1,4-dioxane partitions into vadose pore water (typical VOCs do not significantly partition into vadose pore water).

The estimated XSVE cost for the base case is \$450,000 (Tables 7.3 and 7.3.1) and the estimated duration is 18 months and treatment efficiency 94% based on the demonstration project experience.

7.3.2 Excavation Using Traditional Methods

Excavation using traditional methods means excavation with earth moving equipment and shoring as necessary to remove all of the target soils. The assumptions used for this cost estimate are:

- 20 ft x 20 ft area requiring treatment.
- 38 ft to 68 ft below land surface, overlain by capped sanitary landfill.
- Silty/Clayey sand with 10% soil moisture (unsaturated).
- A 250 ft ramp will be required to excavate to the 68 ft depth.
- The landfill cap and liner at ~ 3 ft depth covers the 400 sq. ft. area that covers municipal and mixed waste to a depth of 38 ft. Surrounding area is also overlain with municipal waste (as it is at McClellan OU-D).
- Clean soil cap can be removed and put aside to access the landfill liner
- Sheet pile will be necessary because to accomplish excavation down to the terminal depth of 68 - 70 ft to avoid ramping all 4 sides of the excavation pit.
- All excavated soil and waste will be disposed at a nonhazardous landfill. Clean fill will be imported and placed in excavation (if disposal as hazardous waste is required cost would be substantially higher).

Table 7.3.2. Cost Detail for Traditional Excavation.

Cost Element	Quantity	Unit	Unit Price	Cost
Pre-Engineering Geotechnical Investigation	1	Lump Sum	\$50,000	\$50,000
Excavation and Stockpile Top Cover of Liner	2,450	yd ³	\$11.00	\$26,950
Install Sheet Wall on 3 Sides of Area	66,375	ft ²	\$8.80	\$519,200
Build Ramp Down to 68 ft depth	18,229	yd ³	\$16.50	\$300,781
Excavate Waste and Contaminated Soil	18,729	yd ³	\$16.50	\$309,031
Nonhazardous Waste Transport & Disposal	18,729	yd ³	\$55.00	\$1,030,104
Clean Fill Placed in Excavation	18,729	yd ³	\$22.00	\$412,042
Replace Liner and Cover; Site Restoration	22,050	ft ²	\$1.10	\$24,255
Subtotal				\$2,672,363
Engineering Design		% of subtotal	8%	\$213,789
Project Management		% of subtotal	5%	\$133,618
Construction Management		% of subtotal	6%	\$160,342
Mobilize Equipment & Personnel to Site		% of subtotal	5%	\$133,618
Demobilize Equipment & Personnel		% of subtotal	5%	\$133,618
Total				\$3,447,348

Traditional excavation is estimated to cost about \$3,400,000 and require about 12 months of project time. Significant cost drivers for conventional excavation is the need to shore the excavation on 3 sides with sheet pile, construction of a ramp on the remaining side for access, landfill costs, and clean fill costs. This approach results in excavation of considerably more soils and waste than need treatment. Traditional excavation however will remove all of the contaminated soil within the target volume, resulting in 100% treatment.

7.3.3 Excavation Using Large Diameter Augers

An alternative approach to excavation which would result in lower cost is the use of large diameter augers. Casing would be driven in advance of the auger followed by auguring inside of the casing with waste or soil removal, then the boring would be filled with a flowable (cement) fill. Cement is allowed to set before the drilling of each adjacent hole. The cementitious fill is necessary for geotechnical stability; however, it prohibits overlap between holes. The result is that only about 75% of the contaminated soil in the target zone would be removed. The assumptions make to cost this approach include:

- 20 ft x 20 ft area requiring treatment.
- 38 ft to 68 ft below land surface, overlain by capped sanitary landfill.
- Silty/Clayey sand with 10% soil moisture (unsaturated).
- A 3 ft diameter auger will be capable of penetration and excavation to the full 68 ft depth
- Flowable concrete fill will be used to allow for hole stabilization, minimal hole overlap will be possible resulting in ~75% of soil removal.
- The landfill cap and liner at ~ 3 ft depth covers the 400 sq. ft. area that covers municipal and mixed waste to a depth of 38 ft. Surrounding area is also overlain with municipal waste (as it is at McClellan OU-D).
- Clean soil cap can be removed and put aside to access the landfill liner.
- No sheet pile will be necessary.
- All excavated soil and waste will be disposed at a nonhazardous landfill. Clean fill will be imported and placed in excavation. If disposal as hazardous waste is required cost would be substantially higher.

Cost details for excavation by large diameter auger are given in Table 7.3.3. Large diameter auger excavation is estimated to cost about \$760,000 and requires about 12 months of project time. This cost is closer to the cost of XSVE than is conventional excavation, however due to the non-overlapping nature of the excavation the treatment efficiency of 75% would be lower than for XSVE and may not achieve remediation goals.

Table 7.3.3. Cost Detail for Excavation by Large Diameter Auger.

Cost Element	Quantity	Unit	Unit Price	Cost
Excavation and Stockpile Top Cover of Liner	113	yd ³	\$11.00	\$1,238
Large Diameter Auger Excavation	1,083	yd ³	\$220.00	\$238,333
Backfill each Casing with Flowable Fill (concrete)	1,083	yd ³	\$110.00	\$119,167
Onsite Loader to Move and Stockpile Material	1,463	yd ³	\$11.00	\$16,088
Nonhazardous Waste Disposal (includes transportation)	1463	yd ³	\$55.00	\$80,438
Replace Liner and Cover; Site Restoration		Lump Sum		\$10,000
Subtotal				\$465,264
Engineering Design		% of total	15%	\$85,658
Project Management		% of total	8%	\$45,684
Construction Management		% of total	10%	\$50,526
Mobilize Equipment & Personnel to Site		% of total	15%	\$75,789
Site Preparation		% of total	10%	\$40,000
Demobilize Equipment & Personnel		% of total	5%	<u>\$25,263</u>
Total				\$758,380

Page Intentionally Left Blank

8.0 IMPLEMENTATION ISSUES

Implementation issues for XSVE are similar to those for the well-developed and well-understood SVE technology. For SVE these issues are described in numerous documents including US Army Corps of Engineer's Soil Vapor Extraction and Bioventing guidance (Army CoE, 2002), DoE's Soil Vapor Extraction System Optimization, Transition and Closure Guidance (Truex et al., 2013), U.S. Air Force's Guidance on Soil Vapor Extraction Optimization (AFCEE, 2001) and USEPA's Soil Vapor Extraction (SVE) Enhancement Technology Resource Guide (USEPA, 1995). High vapor flow rates are required for XSVE, so some sites suitable for SVE may not have sufficient permeability for XSVE. Well construction materials and piping need to be compatible injection well temperatures if heated air injection is used. Heated injection will require additional energy and may result in the need for additional safety measures to prevent direct contact with the heating elements and hot piping. If high relative humidity injection air is used then caution must be exercised to ensure that downward migration of 1,4-dioxane does not occur due to excessive condensation. The authors are not aware of any unique procurement issues associated with XSVE implementation. The equipment necessary is all available off-the-shelf, and to our knowledge there are no patents that would prevent or limit XSVE implementation.

8.1 APPLICABLE REGULATIONS

There is nothing unique to the regulation of XSVE as opposed to SVE. No special permitting or approvals were required for the demonstration; however, it should be noted that the demonstration took place using existing SVE infrastructure which was already permitted. No permitting was required for the heated air injection. However the authors are aware that some regulatory jurisdictions have required permitting for air injection, although this is not common.

8.2 END USERS

End users are always concerned with cost, implementability, and effectiveness. This demonstration has been designed to help end users more effectively understand the costs of XSVE, as well as its implementability and potential effectiveness. Cost and implementation issues are addressed in Sections 7 and 8, respectively. This demonstration shows that under the former McClellan AFB site conditions removal of ~94% of 1,4-dioxane from the vadose zone is feasible, and HypeVent XSVE can assist users in evaluating XSVE performance under different site and operation conditions. This report and the HypeVent XSVE model are designed to allow end users to readily implement the XSVE technology.

Page Intentionally Left Blank

9.0 REFERENCES

- AFCEE, 2001, Guidance on Soil Vapor Extraction Optimization, https://clu-in.org/download/contaminantfocus/dnapl/Treatment_Technologies/SVE-optimization.pdf
- Anderson, R.H., Anderson, J.K. and Bower, P.A., 2012, Co-occurrence of 1,4-Dioxane with Trichloroethylene in Chlorinated Solvent Groundwater Plumes at US Air Force Installations: Fact or Fiction. *Integrated Environmental Assessment and Management*, Apr 10, doi: 10.1002/ieam.1306, Epub ahead of print.
- Army CoE, 2002, Engineering and Design: Soil Vapor Extraction and Bioventing, EM 1110-1-4001.
- CA State Water Resources Control Board, 2015, Groundwater Information Sheet – 1,4-Dioxane, revised May 2014, http://www.waterboards.ca.gov/drinking_water/certlic/drinkingwater/documents/notificationlevels/notificationlevels.pdf
- CH2M Hill, 1992, Site Characterization Technical Memorandum, Soil Vapor Extraction Treatability Investigation Site S within Operable Unit D, McClellan AFB, April 1992.
- Crenshaw, J.L., A.C. Cope, N. Finkelstein, and R. Rogan, 1938, The Dioxanates of the Mercuric Halides, *J. Am. Chem. Soc.*, 60(10):2308-2311.
- DOE, 2009, Pinellas Environmental Restoration Project Interim Remedial Action for Source Removal at the Northeast Site - Final Report.
- Engineering-Science, 1983, IRP Phase II – Confirmation, McClellan AFB, CA, Vol. 1, June 1983.
- Former McClellan Air Force Base Real Property Agency, 2007, Basewide VOC Groundwater Record of Decision, McClellan, CA, August 2007.
- ITRC, 2012, Incremental Sampling Methodology (Technical and Regulatory Guidance).
- Johnson, P.C., C.C. Stanley, M.W. Kemblowski, D.L. Byers and J.D. Colthart, 1990, A Practical Approach to the Design, Operation, and Monitoring of In Situ Soil-Venting Systems, *Ground Water Monitoring Review*, Spring issue, 159 - 178.
- Johnson, P.C. and A.J. Stabenau, 1993, HyperVentilate - A Software Guidance System Created for Vapor Extraction Systems for Apple Macintosh and IBM PC-Compatible Computers. EPA 600/R-93/028.
- Johnson, P.C., 1992, HyperVentilate User's Manual, A Software Guidance System Created for Vapor Extraction Applications, EPA 500-C-B-92-001.
- Johnson, P.C., 1993, HyperVentilate User's Manual (v1.01 and v2.0), A Software Guidance System Created for Vapor Extraction Applications, EPA 510-R-93-001.

Page Intentionally Left Blank

APPENDIX A BORING LOGS

Project: OU D XSVE

Log of Soil Vapor Injection Well: IW-21

Location: McClellan Park, Sacramento, CA

Project: 17327101

Drilling Contractor: National	Drilled by: James Freitas	Borehole Name: OUDSB-XSVE2	Logged By: J. Brandon
Drilling Method: HSA	Dates Drilled: 09/23/14	Well Construction: 09/26/14	Checked By: T. Cudzilo P.G. 4473 <i>TC</i>
Borehole Diameter: 8-inch	Casing Diameter: 2-inch	Casing Type: Low Carbon Steel	QC Initial: K. Touchi
Total Depth Drilled: 75 feet bgs	Screen Interval: 38 - 68	Slot Size: 0.020-inch	Ground Surface Elevation: NM
Sampling Method: Discrete/Continuous Core	Top of Casing Elevation: NM	Northing: 2006908.114 Easting: 6728129.590	

Comments: Discrete sampling every 5 feet from 5-35 feet bgs. Continuous core from 35 to 75 feet bgs. GPS from center of borehole.

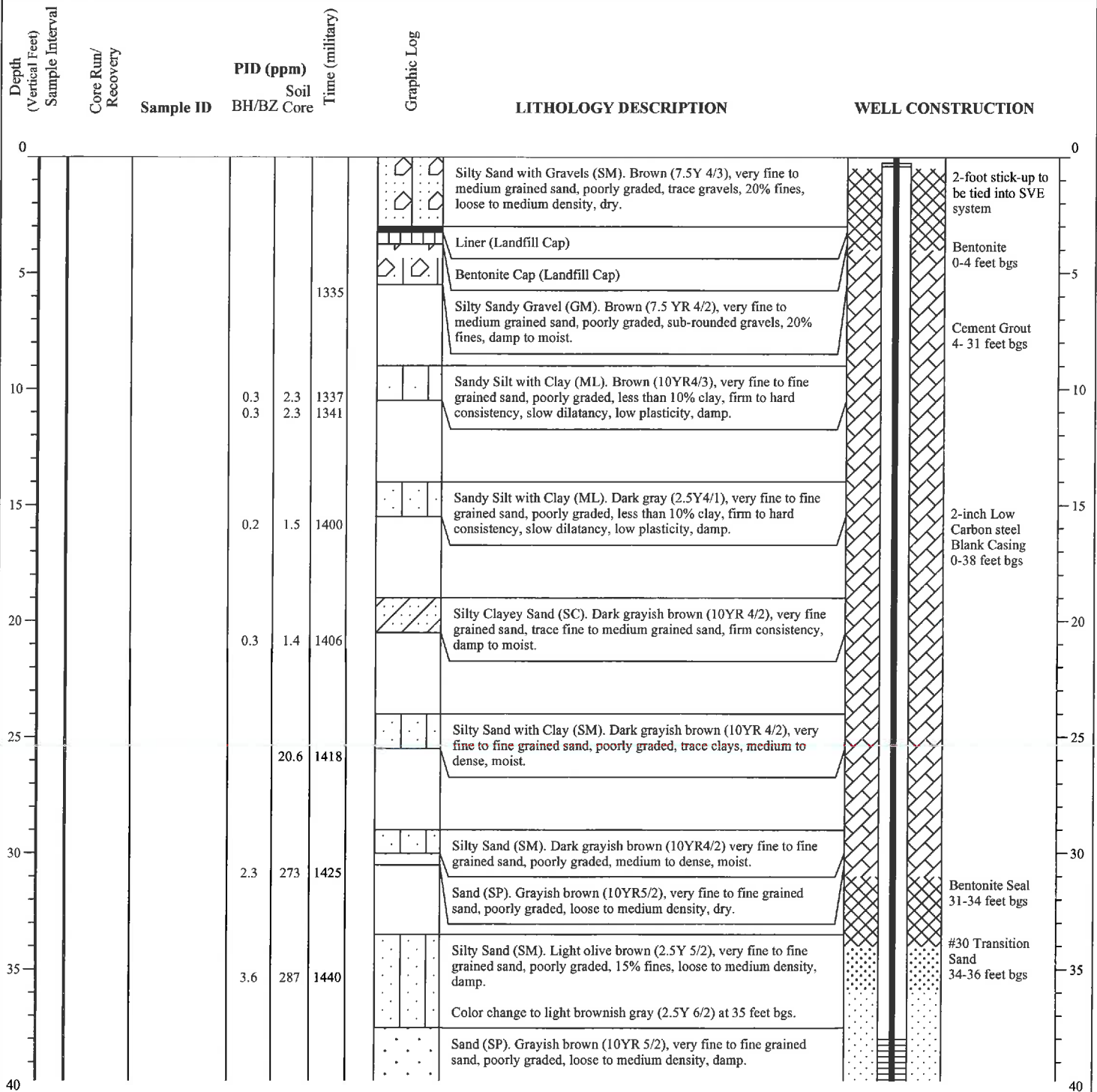

Appendix A

Boring Logs

Project: OU D XSVE

Log of Soil Vapor Injection Well: IW-21

Location: McClellan Park, Sacramento, CA

Project: 17327101

Drilling Contractor: National	Drilled by: James Freitas	Borehole Name: OUDSB-XSVE2	Logged By: J. Brandon
Drilling Method: HSA	Dates Drilled: 09/23/14	Well Construction: 09/26/14	Checked By: T. Cudzilo P.G. 4473
Borehole Diameter: 8-inch	Casing Diameter: 2-inch	Casing Type: Low Carbon Steel	QC Initial: K. Touchi
Total Depth Drilled: 75 feet bgs	Screen Interval: 38 - 68	Slot Size: 0.020-inch	Ground Surface Elevation: NM
Sampling Method: Discrete/Continuous Core	Top of Casing Elevation: NM	Northing: 2006908.114 Easting: 6728129.590	

Comments: Discrete sampling every 5 feet from 5-35 feet bgs. Continuous core from 35 to 75 feet bgs. GPS from center of borehole.

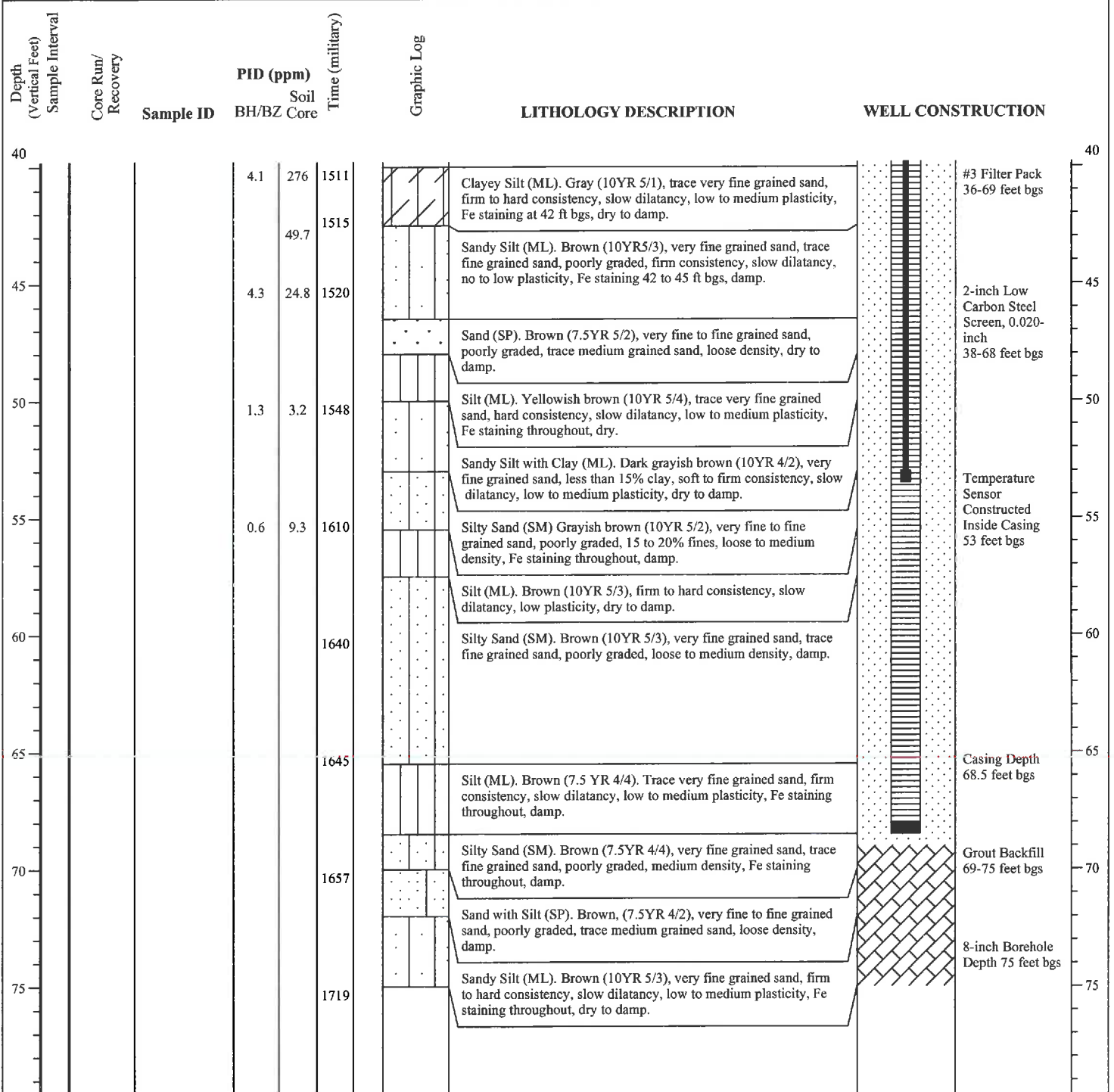

Project: OU D XSVE

Log of Soil Vapor Injection Well: IW-22

Location: McClellan Park, Sacramento, CA

Project: 17327101

Drilling Contractor: National	Drilled by: James Freitas	Borehole Name: OUD-SB-IW2	Logged By: J. Brandon
Drilling Method: HSA	Dates Drilled: 09/23/14	Well Construction: 09/25/14	Checked By: T. Cudzilo P.G. 4473 <i>TCE</i>
Borehole Diameter: 8-inch	Casing Diameter: 2-inch	Casing Type: Low Carbon Steel	QC Initial: K. Touchi
Total Depth Drilled: 69 feet bgs	Screen Interval: 38 - 68	Slot Size: 0.020-inch	Ground Surface Elevation: NM
Sampling Method: NA	Top of Casing Elevation: NM	Northing: 2006911.316 Easting: 6728149.451	

Comments: GPS Northing and Easting data collected from center of borehole.

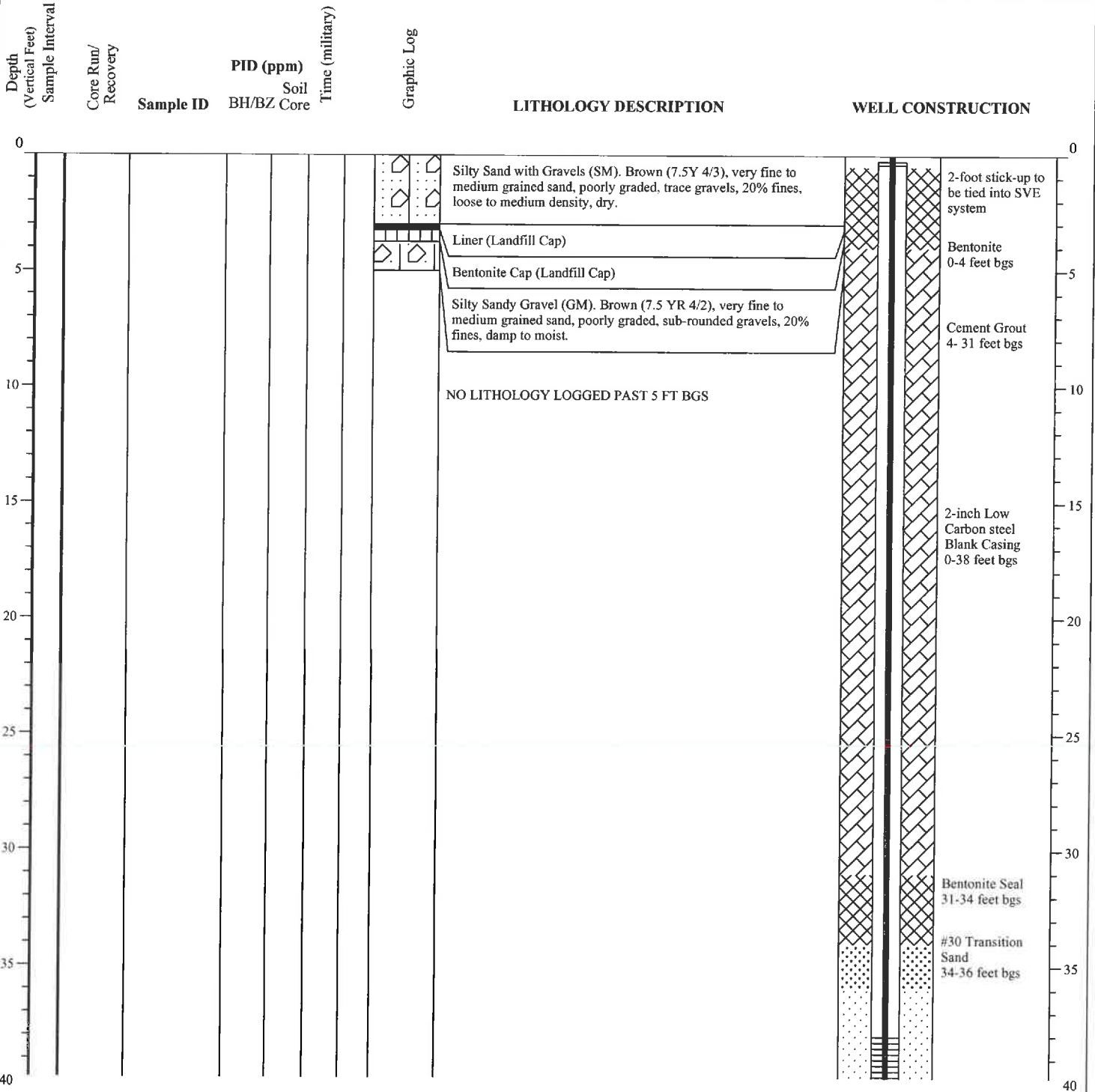

Project: OU D XSVE

Log of Soil Vapor Injection Well: IW-22

Location: McClellan Park, Sacramento, CA

Project: 17327101

Drilling Contractor: National	Drilled by: James Freitas	Borehole Name: OUD-SB-IW2	Logged By: J. Brandon
Drilling Method: HSA	Dates Drilled: 09/23/14	Well Construction: 09/25/14	Checked By: T. Cudzilo P.G. 4473
Borehole Diameter: 8-inch	Casing Diameter: 2-inch	Casing Type: Low Carbon Steel	QC Initial: K. Touchi
Total Depth Drilled: 69 feet bgs	Screen Interval: 38 - 68	Slot Size: 0.020-inch	Ground Surface Elevation: NM
Sampling Method: NA	Top of Casing Elevation: NM	Northing: 2006911.316 Easting: 6728149.451	

Comments: GPS Northing and Easting data collected from center of borehole.

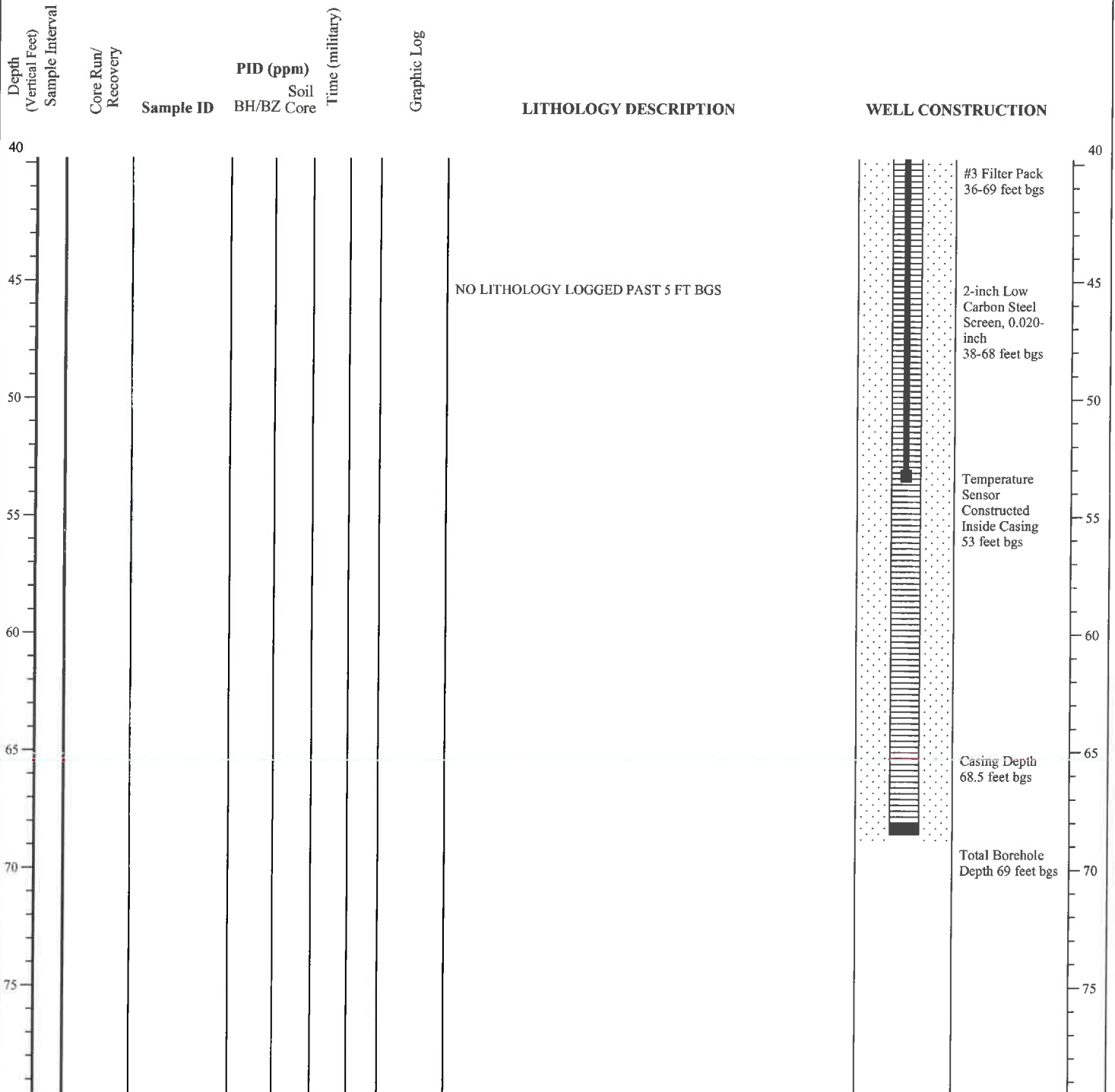

Project: OUD XSVE

Log of Soil Vapor Injection Well:

Location: McClellan Park, Sacramento, CA

Project: 17327101

IW-23

Drilling Contractor: National	Drilled by: James Freitas	Borehole Name: OUD-SB-IW3	Logged By: J. Brandon
Drilling Method: HSA	Dates Drilled: 10/03/14	Well Construction: 10/06/14	Checked By: T. Cudzilo P.G. 4473 <i>TC</i>
Borehole Diameter: 8-inch	Casing Diameter: 2-inch	Casing Type: Low Carbon Steel	QC by: K. Touchi
Total Depth Drilled: 69 feet	Screen Intervals: 38 - 68	Slot Size: 0.020-inch	
Sampling Method: NA	Top of Casing Elevations: NM	Ground Surface Elevation: NM	

Northing: 2006930.317 Easting: 6728146.323

Comments: GPS Northing and Easting data collected from center of borehole.

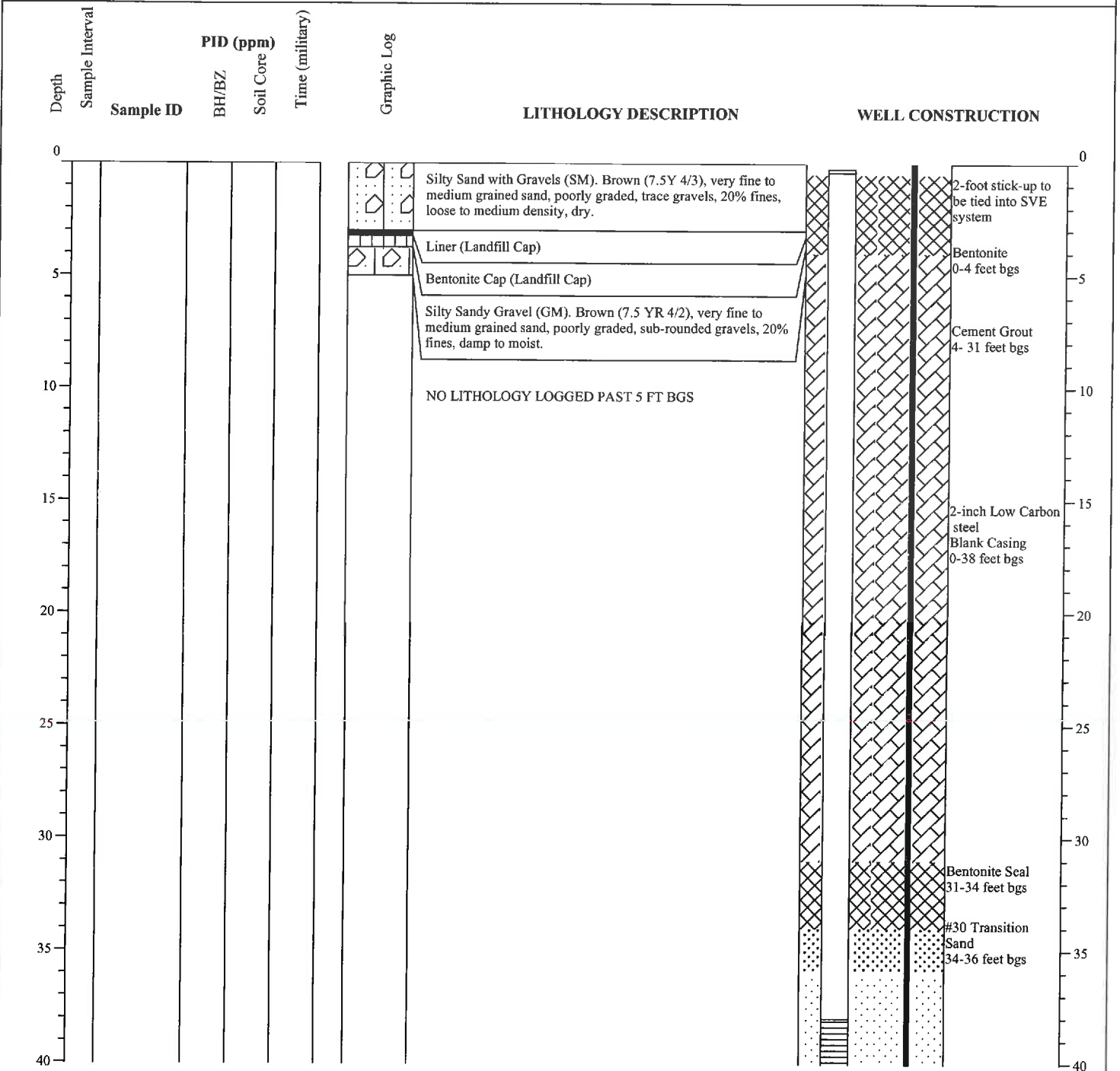

Project: OUD XSVE

Log of Soil Vapor Injection Well: IW-23

Location: McClellan Park, Sacramento, CA

Project: 17327101

Drilling Contractor: National	Drilled by: James Freitas	Borehole Name: OUD-SB-IW3	Logged By: J. Brandon
Drilling Method: HSA	Dates Drilled: 10/03/14	Well Construction: 10/06/14	Checked By: T. Cudzilo P.G. 4473
Borehole Diameter: 8-inch	Casing Diameter: 2-inch	Casing Type: Low Carbon Steel	QC by: K. Touchi
Total Depth Drilled: 69 feet	Screen Intervals: 38 - 68	Slot Size: 0.020-inch	
Sampling Method: NA	Top of Casing Elevations: NM	Ground Surface Elevation: NM	

Northing: 2006930.317 Easting: 6728146.323

Comments: GPS Northing and Easting data collected from center of borehole.

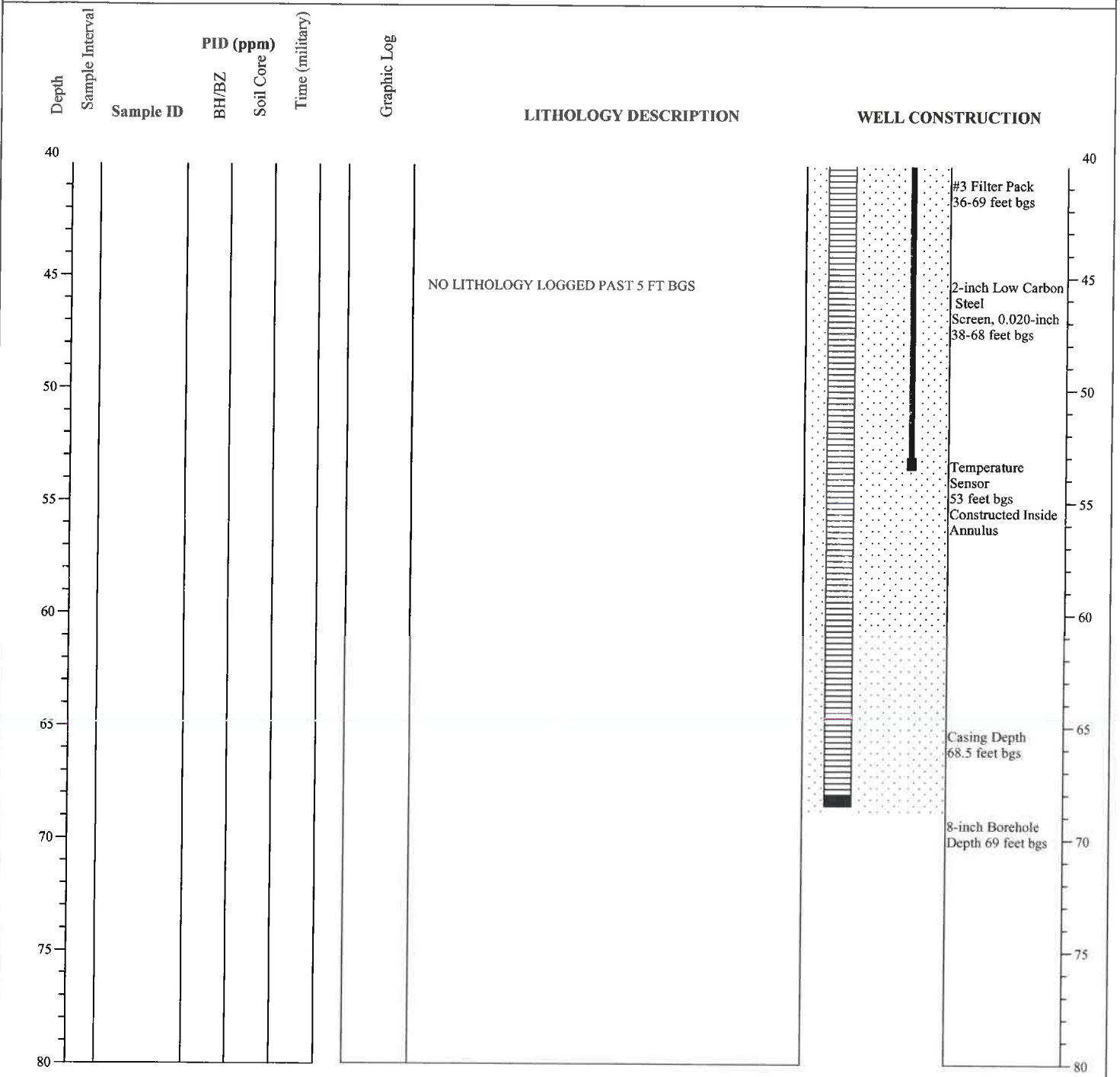

Drilling Contractor: National	Drilled by: James Freitas	Borehole Name: OUD-SB-IW4	Logged By: J. Brandon
Drilling Method: HSA	Dates Drilled: 10/06/14	Well Construction: 10/07/14	Checked By: T. Cudzilo P.G. 4473 <i>TC</i>
Borehole Diameter: 8-inch	Casing Diameter: 2-inch	Casing Type: Low Carbon Steel	QC by: K. Touchi
Total Depth Drilled: 69 feet	Screen Intervals: 38 - 68	Slot Size: 0.020-inch	
Sampling Method: NA	Top of Casing Elevations: NM	Ground Surface Elevation: NM	

Northing: 2006928.249 Easting: 6728126.205

Comments: GPS Northing and Easting data collected from center of borehole.

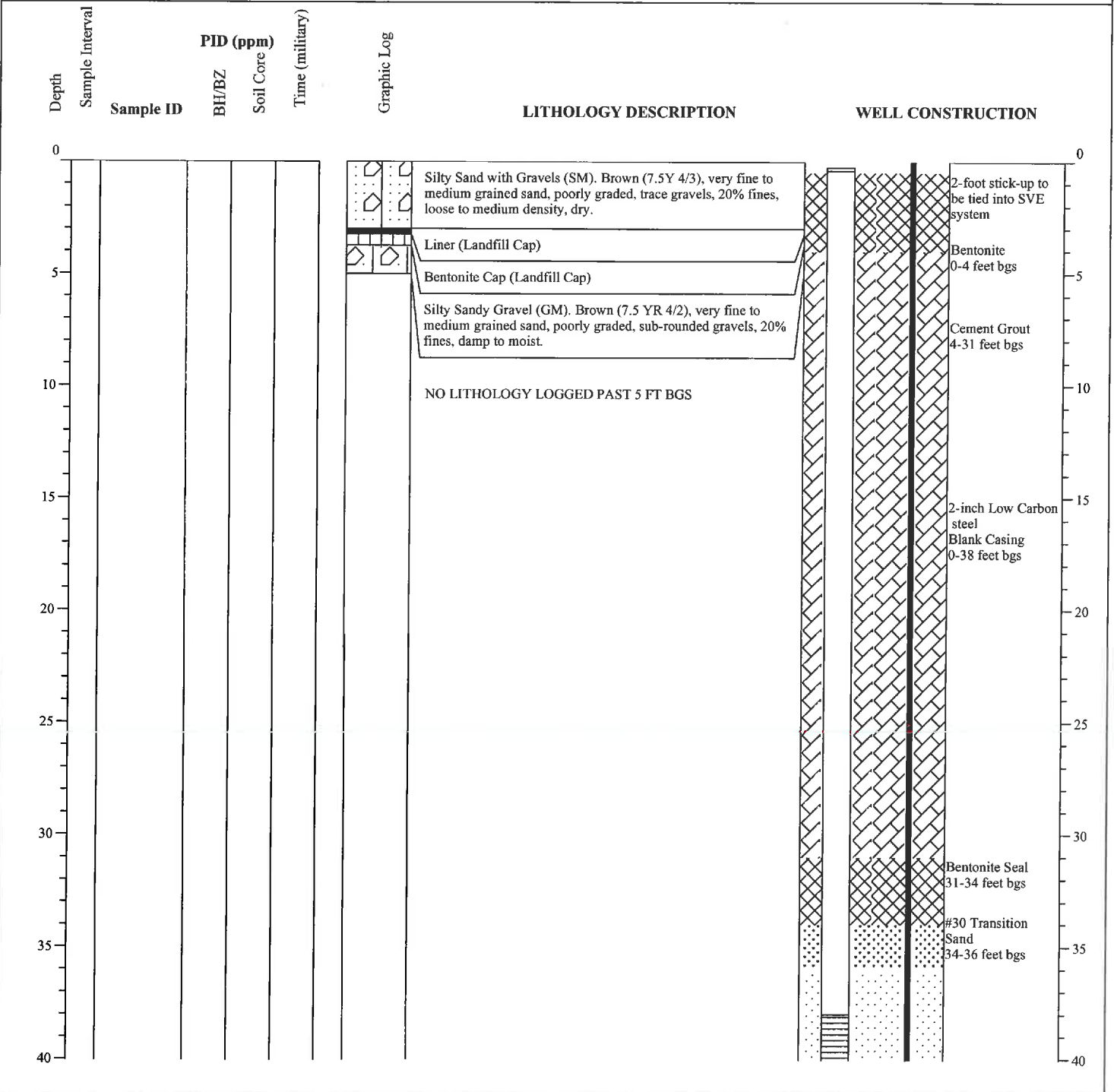

Drilling Contractor: National	Drilled by: James Freitas	Borehole Name: OUD-SB-IW4	Logged By: J. Brandon
Drilling Method: HSA	Dates Drilled: 10/06/14	Well Construction: 10/07/14	Checked By: T. Cudzilo P.G. 4473
Borehole Diameter: 8-inch	Casing Diameter: 2-inch	Casing Type: Low Carbon Steel	QC by: K. Touchi
Total Depth Drilled: 69 feet	Screen Intervals: 38 - 68	Slot Size: 0.020-inch	
Sampling Method: NA	Top of Casing Elevations: NM	Ground Surface Elevation: NM	

Northing: 2006928.249 Easting: 6728126.205

Comments: GPS Northing and Easting data collected from center of borehole.

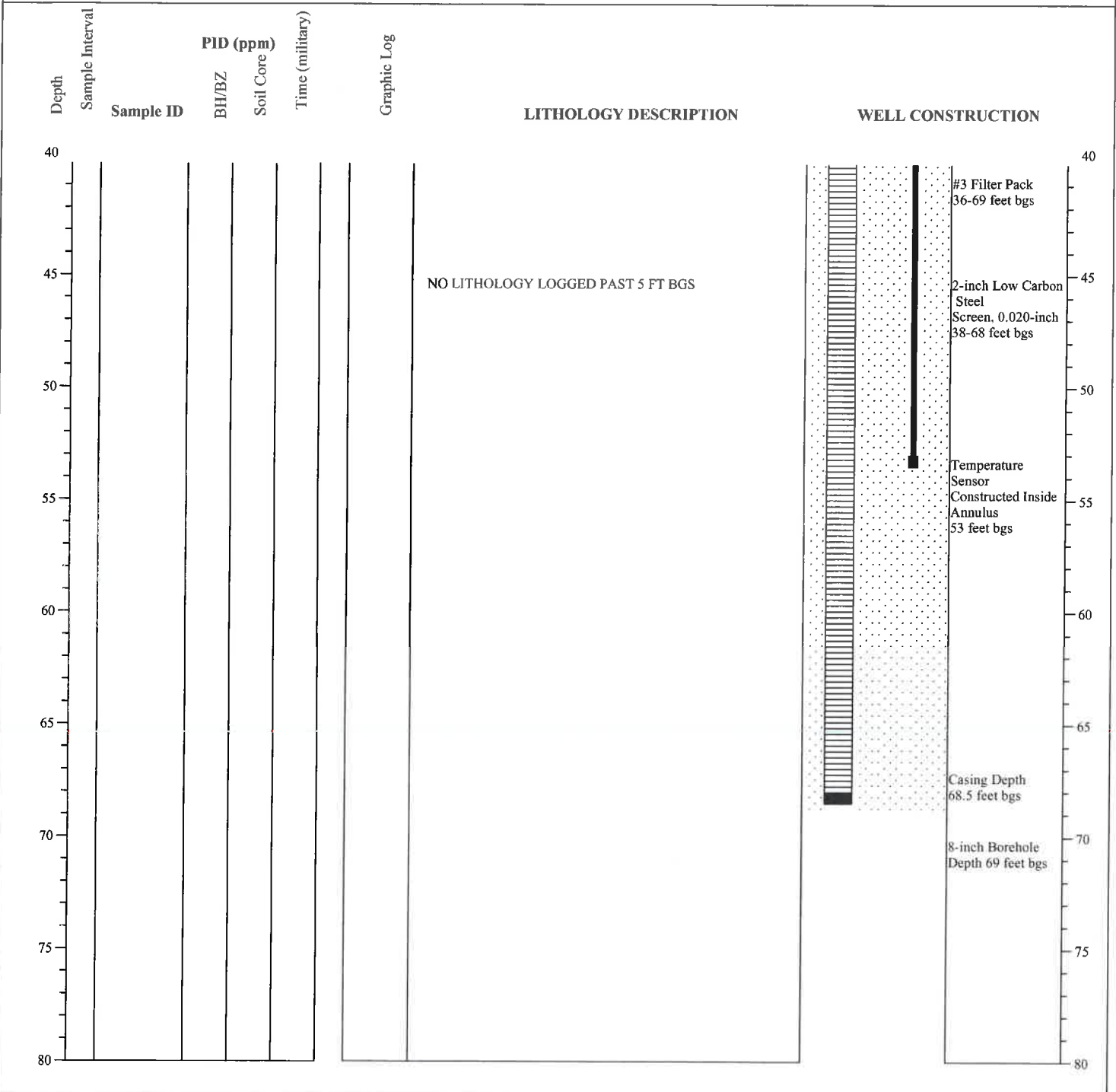

Project: OU D XSVE

Log of SVE Well:

Location: McClellan Park, Sacramento, CA

Project: 17327101

EW 503

Drilling Contractor: National	Drilled by: James Freitas	Borehole Name: OUDSB-XSVE1	Logged By: J. Brandon
Drilling Method: HSA	Dates Drilled: 09/22/14-09/23/14	Well Construction: 09/25/14	Checked By: T. Cruzilo P.G. 4472 <i>T. Cruzilo</i>
Borehole Diameter: 10-inch	Casing Diameter: 4-inch	Casing Type: Low Carbon Steel	QC Initial: K. Touchi
Total Depth Drilled: 75 feet bgs	Screen Interval: 38 - 68	Slot Size: 0.020-inch	Ground Surface Elevation: NM
Sampling Method: Discrete/Continuous Core	Top of Casing Elevation: NM	Northing: 2006919.311 Easting: 6728137.861	

Comments: Discrete sampling every 5 feet from 5-35 feet bgs. Continuous core from 35 to 75 feet bgs. GPS from center of borehole.

Depth (Vertical Feet) Sample Interval	Core Run/ Recovery	Sample ID	PID (ppm)		Time (military)	Graphic Log	LITHOLOGY DESCRIPTION	WELL CONSTRUCTION
			BH/BZ	Soil Core				
0								
0-5						<p>Silty Sand with Gravels (SM). Brown (7.5Y 4/3), very fine to medium grained sand, poorly graded, trace gravels, 20% fines, loose to medium density, dry.</p> <p>Liner (Landfill Cap)</p> <p>Bentonite Cap (Landfill Cap)</p>	<p>2-foot stick-up to be tied into SVE system</p> <p>Bentonite 0-4 feet bgs</p>	
5-10			0.0	0.0	1304	<p>Silty Sandy Gravel (GM). Brown (7.5 YR 4/2), very fine to medium grained sand, poorly graded, sub-rounded gravels, 20% fines, damp to moist.</p>	<p>Cement Grout 4-31 feet bgs</p>	
10-15			0.0	0.0	1310	<p>Silty Sand (SM). Brown (10YR4/3), very fine to fine grained sand, poorly graded, trace gravels, damp.</p>		
15-20			0.0	1.2	1315	<p>Silty Sand (SM). Gray (10YR 5/1), very fine to fine grained sand, poorly graded, 15-20% fines, trace clays, medium density, damp.</p>	<p>4-inch Low Carbon steel Blank Casing 0-38 feet bgs</p>	
20-25			3.6	38	1320	<p>Silty Clayey Sand (SC). Dark grayish brown (10YR 4/2), very fine grained sand, trace fine to medium grained sand, firm consistency, damp to moist.</p>		
25-30			3.7	38	1324			
30-35			4.5	33.1	1333	<p>Silty Sand with Clay (SM). Dark grayish brown (10YR 4/2), very fine to fine grained sand, poorly graded, trace clays, medium to dense, moist.</p>		
35-40			4.2	352	1345	<p>Silty Sand (SM). Dark grayish brown (10YR4/2) very fine to fine grained sand, poorly graded, medium to dense, moist.</p> <p>Sand (SP). Grayish brown (10YR5/2), very fine to fine grained sand, poorly graded, loose to medium density, dry.</p>	<p>Bentonite Seal 31-34 feet bgs</p>	
40-45			2.7	818	1355	<p>Silty Sand (SM). Light olive brown (2.5Y 5/2), very fine to fine grained sand, poorly graded, 15% fines, loose to medium density, damp.</p> <p>Color change to light brownish gray (2.5Y 6/2) at 35 feet bgs.</p>	<p>#30 Transition Sand 34-36 feet bgs</p>	
45-50						<p>Sand (SP). Grayish brown (10YR 5/2), very fine to fine grained sand, poorly graded, loose to medium density, damp.</p>		

Project: OUD XSVE

Log of SVE Well: EW 503

Location: McClellan Park, Sacramento, CA

Project: 17327101

Drilling Contractor: National	Drilled by: James Freitas	Borehole Name: OUDSB-XSVE1	Logged By: J. Brandon
Drilling Method: HSA	Dates Drilled: 09/22/14-09/23/14	Well Construction: 09/25/14	Checked By: T. Cudzilo P.G. 4473
Borehole Diameter: 10-inch	Casing Diameter: 4-inch	Casing Type: Low Carbon Steel	QC Initial: K. Touchi
Total Depth Drilled: 75 feet bgs	Screen Interval: 38 - 68	Slot Size: 0.020-inch	Ground Surface Elevation: NM
Sampling Method: Discrete/Continuous Core	Top of Casing Elevation: NM	Northing: 2006919.311 Easting: 6728137.861	

Comments: Discrete sampling every 5 feet from 5-35 feet bgs. Continuous core from 35 to 75 feet bgs. GPS from center of borehole.

Depth (Vertical Feet) Sample Interval	Core Run/ Recovery	PID (ppm)		Time (military)	Graphic Log	LITHOLOGY DESCRIPTION	WELL CONSTRUCTION
		Soil BH/BZ	Core				
40		1.2	285	0830		Clayey Silt (ML). Gray (10YR 5/1), trace very fine grained sand, firm to hard consistency, slow dilatancy, low to medium plasticity, Fe staining at 42 ft bgs, dry to damp.	#3 Filter Pack 36-69 feet bgs
		1.5	136				
45		1.3	200	0850		Sandy Silt (ML). Brown (10YR5/3), very fine grained sand, trace fine grained sand, poorly graded, firm consistency, slow dilatancy, no to low plasticity, Fe staining at 42 to 45 ft bgs, damp.	
		1.4	125				
50		1.3	54.6	0920		Sand (SP). Brown (7.5YR 5/2), very fine to fine grained sand, poorly graded, trace medium grained sand, loose density, dry to damp.	4-inch Low Carbon Steel Screen, 0.020-inch 38-68 feet bgs
		1.6	18.1				
55		1.4	20.3	0955		Silt (ML). Yellowish brown (10YR 5/4), trace very fine grained sand, hard consistency, slow dilatancy, low to medium plasticity, Fe staining throughout, dry.	
		1.3	15.2				
60		1.3	20.1	1030		Silty Sand (SM). Brown (10YR 5/3), very fine grained sand, trace fine grained sand, poorly graded, loose to medium density, Fe staining throughout, damp.	Casing Depth 68.5 feet bgs
		1.2	10.1				
65		1.1	8.9	1100		Silt (ML). Brown (7.5 YR 4/4). Trace very fine grained sand, firm consistency, slow dilatancy, low to medium plasticity, Fe staining throughout, damp.	10-inch Borehole Depth 69 feet bgs
		1.0	8.6	1115			
70		0.8	3.6			Sand with Silt (SP). Brown, (7.5YR 4/2). very fine to fine grained sand, poorly graded, trace medium grained sand, loose density, damp.	8-inch Borehole Depth 75 feet bgs
		0.9	2.4	1140			
75						Sandy Silt (ML). Brown (10YR 5/3), very fine grained sand, firm to hard consistency, slow dilatancy, low to medium plasticity, Fe staining throughout, dry to damp.	

Project: OU D XSVE

Log of SVE Well:

Location: McClellan Park, Sacramento, CA

Project: 17327101

EW 503

Drilling Contractor: National	Drilled by: James Freitas	Borehole Name: OUDSB-XSVE1	Logged By: J. Brandon
Drilling Method: HSA	Dates Drilled: 09/22/14-09/23/14	Well Construction: 09/25/14	Checked By: T. Cruzilo P.G. 4472 <i>T. Cruzilo</i>
Borehole Diameter: 10-inch	Casing Diameter: 4-inch	Casing Type: Low Carbon Steel	QC Initial: K. Touchi
Total Depth Drilled: 75 feet bgs	Screen Interval: 38 - 68	Slot Size: 0.020-inch	Ground Surface Elevation: NM
Sampling Method: Discrete/Continuous Core	Top of Casing Elevation: NM	Northing: 2006919.311 Easting: 6728137.861	

Comments: Discrete sampling every 5 feet from 5-35 feet bgs. Continuous core from 35 to 75 feet bgs. GPS from center of borehole.

Depth (Vertical Feet) Sample Interval	Core Run/ Recovery	Sample ID	PID (ppm)		Time (military)	Graphic Log	LITHOLOGY DESCRIPTION	WELL CONSTRUCTION
			BH/BZ	Soil Core				
0								
0-5						<p>Silty Sand with Gravels (SM). Brown (7.5Y 4/3), very fine to medium grained sand, poorly graded, trace gravels, 20% fines, loose to medium density, dry.</p> <p>Liner (Landfill Cap)</p> <p>Bentonite Cap (Landfill Cap)</p>	<p>2-foot stick-up to be tied into SVE system</p> <p>Bentonite 0-4 feet bgs</p>	
5-10			0.0	0.0	1304	<p>Silty Sandy Gravel (GM). Brown (7.5 YR 4/2), very fine to medium grained sand, poorly graded, sub-rounded gravels, 20% fines, damp to moist.</p>	<p>Cement Grout 4-31 feet bgs</p>	
10-15			0.0	0.0	1310	<p>Silty Sand (SM). Brown (10YR4/3), very fine to fine grained sand, poorly graded, trace gravels, damp.</p>		
15-20			0.0	1.2	1315	<p>Silty Sand (SM). Gray (10YR 5/1), very fine to fine grained sand, poorly graded, 15-20% fines, trace clays, medium density, damp.</p>	<p>4-inch Low Carbon steel Blank Casing 0-38 feet bgs</p>	
20-25			3.6	38	1320	<p>Silty Clayey Sand (SC). Dark grayish brown (10YR 4/2), very fine grained sand, trace fine to medium grained sand, firm consistency, damp to moist.</p>		
25-30			3.7	38	1324			
30-35			4.5	33.1	1333	<p>Silty Sand with Clay (SM). Dark grayish brown (10YR 4/2), very fine to fine grained sand, poorly graded, trace clays, medium to dense, moist.</p>		
35-40			4.2	352	1345	<p>Silty Sand (SM). Dark grayish brown (10YR4/2) very fine to fine grained sand, poorly graded, medium to dense, moist.</p> <p>Sand (SP). Grayish brown (10YR5/2), very fine to fine grained sand, poorly graded, loose to medium density, dry.</p>	<p>Bentonite Seal 31-34 feet bgs</p>	
40-45			2.7	818	1355	<p>Silty Sand (SM). Light olive brown (2.5Y 5/2), very fine to fine grained sand, poorly graded, 15% fines, loose to medium density, damp.</p> <p>Color change to light brownish gray (2.5Y 6/2) at 35 feet bgs.</p> <p>Sand (SP). Grayish brown (10YR 5/2), very fine to fine grained sand, poorly graded, loose to medium density, damp.</p>	<p>#30 Transition Sand 34-36 feet bgs</p>	

Project: OUD XSVE

Log of SVE Well: EW 503

Location: McClellan Park, Sacramento, CA

Project: 17327101

Drilling Contractor: National	Drilled by: James Freitas	Borehole Name: OUDSB-XSVE1	Logged By: J. Brandon
Drilling Method: HSA	Dates Drilled: 09/22/14-09/23/14	Well Construction: 09/25/14	Checked By: T. Cudzilo P.G. 4473
Borehole Diameter: 10-inch	Casing Diameter: 4-inch	Casing Type: Low Carbon Steel	QC Initial: K. Touchi
Total Depth Drilled: 75 feet bgs	Screen Interval: 38 - 68	Slot Size: 0.020-inch	Ground Surface Elevation: NM
Sampling Method: Discrete/Continuous Core	Top of Casing Elevation: NM	Northing: 2006919.311 Easting: 6728137.861	

Comments: Discrete sampling every 5 feet from 5-35 feet bgs. Continuous core from 35 to 75 feet bgs. GPS from center of borehole.

Depth (Vertical Feet) Sample Interval	Core Run/ Recovery	PID (ppm)		Time (military)	Graphic Log	LITHOLOGY DESCRIPTION	WELL CONSTRUCTION
		Soil BH/BZ	Core				
40		1.2	285	0830		Clayey Silt (ML). Gray (10YR 5/1), trace very fine grained sand, firm to hard consistency, slow dilatancy, low to medium plasticity, Fe staining at 42 ft bgs, dry to damp.	#3 Filter Pack 36-69 feet bgs
		1.5	136				
45		1.3	200	0850		Sandy Silt (ML). Brown (10YR5/3), very fine grained sand, trace fine grained sand, poorly graded, firm consistency, slow dilatancy, no to low plasticity, Fe staining at 42 to 45 ft bgs, damp.	
		1.4	125				
50		1.3	54.6	0920		Sand (SP). Brown (7.5YR 5/2), very fine to fine grained sand, poorly graded, trace medium grained sand, loose density, dry to damp.	4-inch Low Carbon Steel Screen, 0.020-inch 38-68 feet bgs
		1.6	18.1				
55		1.4	20.3	0955		Silt (ML). Yellowish brown (10YR 5/4), trace very fine grained sand, hard consistency, slow dilatancy, low to medium plasticity, Fe staining throughout, dry.	
		1.3	15.2				
60		1.3	20.1	1030		Silty Sand (SM). Brown (10YR 5/3), very fine grained sand, trace fine grained sand, poorly graded, loose to medium density, Fe staining throughout, damp.	Casing Depth 68.5 feet bgs
		1.2	10.1				
65		1.1	8.9	1100		Silt (ML). Brown (7.5 YR 4/4). Trace very fine grained sand, firm consistency, slow dilatancy, low to medium plasticity, Fe staining throughout, damp.	10-inch Borehole Depth 69 feet bgs
		1.0	8.6	1115			
70		0.8	3.6			Sand with Silt (SP). Brown, (7.5YR 4/2). very fine to fine grained sand, poorly graded, trace medium grained sand, loose density, damp.	8-inch Borehole Depth 75 feet bgs
		0.9	2.4	1140			
75						Sandy Silt (ML). Brown (10YR 5/3), very fine grained sand, firm to hard consistency, slow dilatancy, low to medium plasticity, Fe staining throughout, dry to damp.	

Project: OUD XSVE

Location: McClellan Park, Sacramento, CA

Project: 17327101

Log of Vapor Monitoring Wells: MW-686, MW-687

Drilling Contractor: National	Drilled by: James Freitas	Borehole Name: OUD-SB-XVMW1S/D	Logged By: J. Brandon
Drilling Method: HSA	Dates Drilled: 09/26/14-09/29/14	Well Construction: 09/30/14	QC: K. Touchi
Borehole Diameter: 10-inch	Casing Dia.: 0.5-inch	Casing Type: CPVC	Checked by: T. Cudzilo P.G.4473 <i>TC</i>
Total Depth Drilled: 76 feet	Screen Intervals: 47-48/ 62-63	Slot Size: 0.020-inch	
Sampling Method: Continuous Core	Top of Casing Elevations: NM	Ground Surface Elevation: NM	

Northing: 2006915.504 Easting: 6728134.851

Comments: Continuous core from 35 to 76 feet bgs. GPS Northing and Easting data collected from center of borehole.

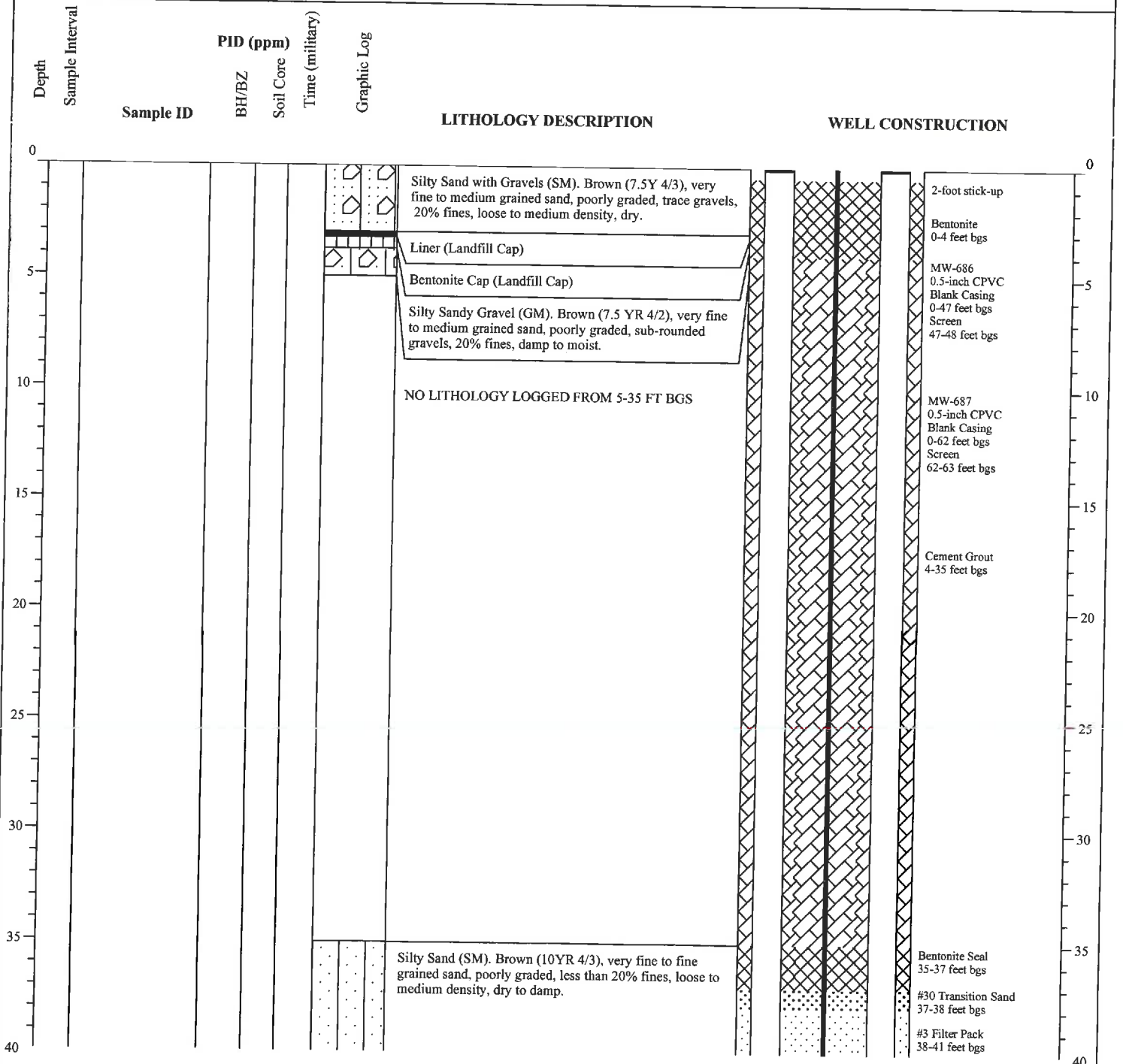

Project: OUD XSVE

Location: McClellan Park, Sacramento, CA

Project: 17327101

Log of Vapor Monitoring Wells:

MW-686, MW-687

Drilling Contractor: National	Drilled by: James Freitas	Borehole Name: OUD-SB-XVMW1S/D	Logged By: J. Brandon
Drilling Method: HSA	Dates Drilled: 09/26/14-09/29/14	Well Construction: 09/30/14	QC: K. Touchi
Borehole Diameter: 10-inch	Casing Dia.: 0.5-inch	Casing Type: CPVC	Checked by: T. Cudzilo P.G.4473
Total Depth Drilled: 76 feet	Screen Intervals: 47-48/ 62-63		Slot Size: 0.020-inch
Sampling Method: Continuous Core	Top of Casing Elevations: NM		Ground Surface Elevation: NM

Northing: 2006915.504 Easting: 6728134.851

Comments: Continuous core from 35 to 76 feet bgs. GPS Northing and Easting data collected from center of borehole.

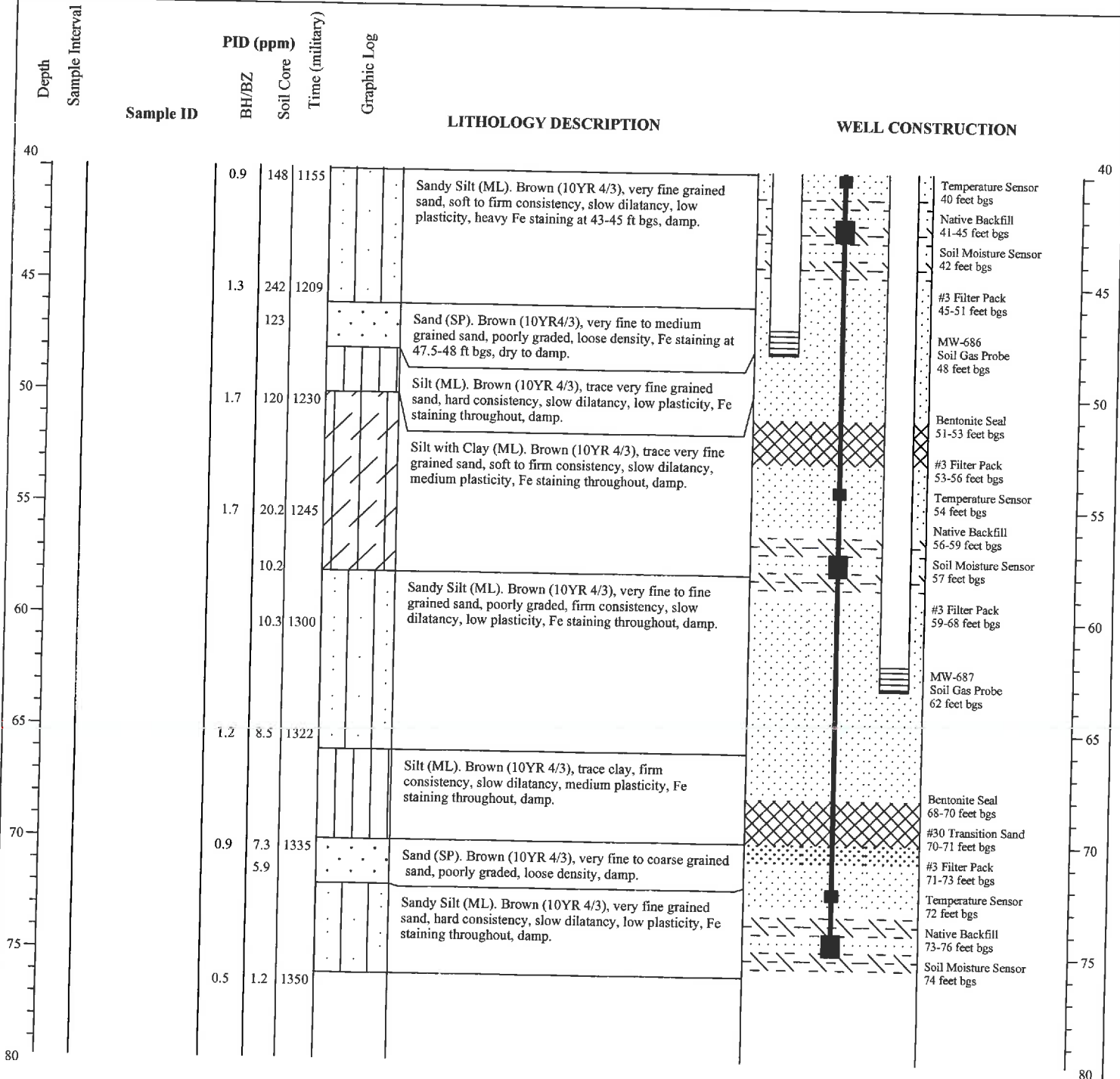

Project: OUD XSVE

Location: McClellan Park, Sacramento, CA

Project: 17327101

Log of Vapor Monitoring Wells:

MW-688, MW-689

Drilling Contractor: National	Drilled by: James Freitas	Borehole Name: OUD-SB-XVMW2S/D	Logged By: J. Brandon
Drilling Method: HSA	Dates Drilled: 10/01/14-10/03/14	Well Construction: 10/03/14	QC: K. Touchi
Borehole Diameter: 10-inch	Casing Dia.: 0.5-inch	Casing Type: CPVC	Checked by: T. Cudzilo P.G.4473 <i>TCE</i>
Total Depth Drilled: 77 feet	Screen Intervals: 47-48/ 62-63	Slot Size: 0.020-inch	
Sampling Method: Continuous Core	Top of Casing Elevations: NM	Ground Surface Elevation: NM	

Northing: 2006913.711 Easting: 6728145.811

Comments: Continuous core from 35 to 77 feet bgs. GPS Northing and Easting data collected from center of borehole.

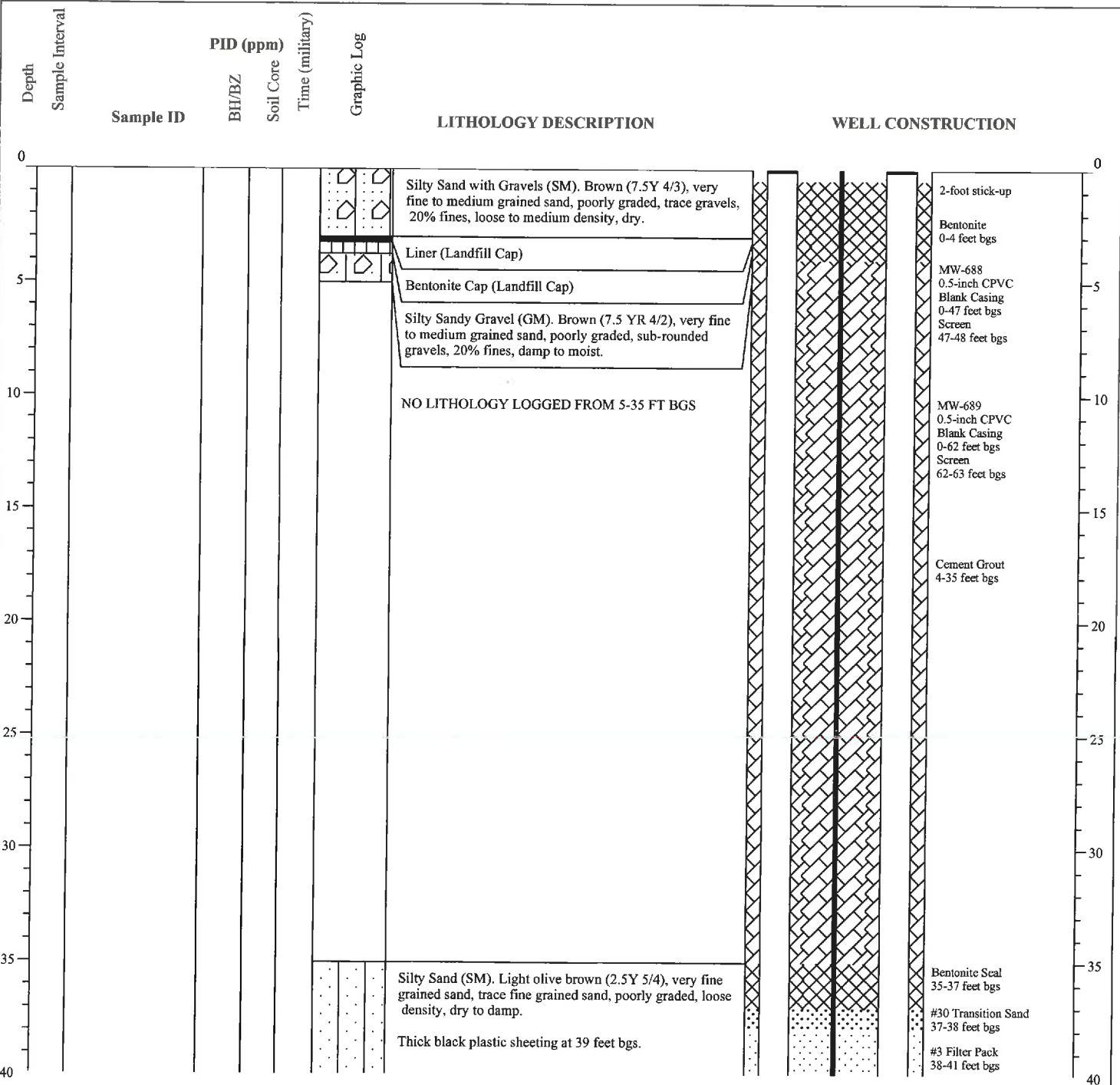

Drilling Contractor: National	Drilled by: James Freitas	Borehole Name: OUD-SB-XVMWZS/D	Logged By: J. Brandon
Drilling Method: HSA	Dates Drilled: 10/01/14-10/03/14	Well Construction: 10/03/14	QC: K. Touchi
Borehole Diameter: 10-inch	Casing Dia.: 0.5-inch	Casing Type: CPVC	Checked by: T. Cudzilo P.G.4473
Total Depth Drilled: 77 feet	Screen Intervals: 47-48/ 62-63	Slot Size: 0.020-inch	
Sampling Method: Continuous Core	Top of Casing Elevations: NM	Ground Surface Elevation: NM	

Northing: 2006913.711 Easting: 6728145.811

Comments: Continuous core from 35 to 77 feet bgs. GPS Northing and Easting data collected from center of borehole.

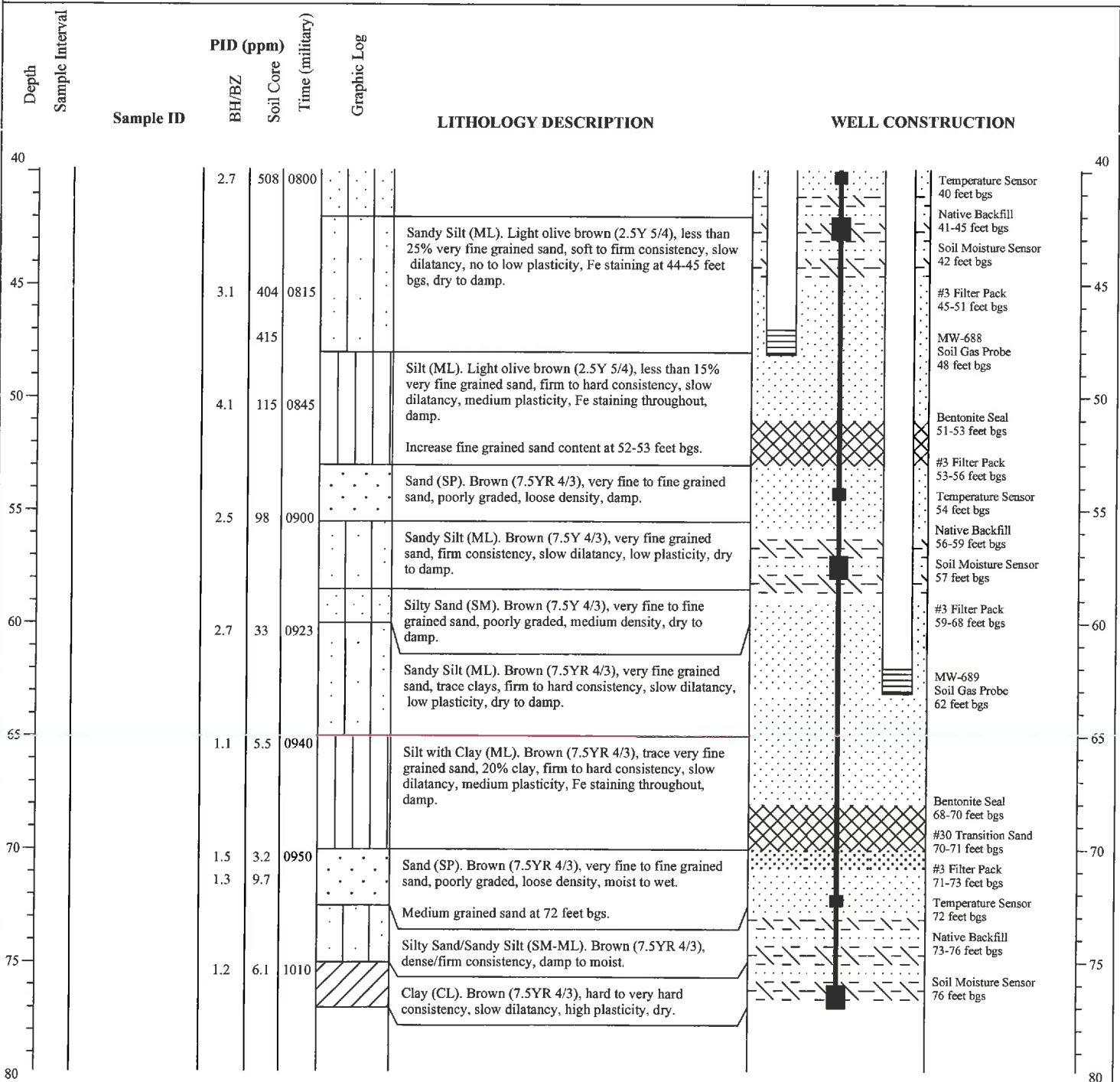

Drilling Contractor: National	Drilled by: James Freitas	Borehole Name: OUD-SB-XVMW3S/D	Logged By: J. Brandon
Drilling Method: HSA	Dates Drilled: 09/26/14-09/29/14	Well Construction: 10/01/14	QC: K. Touchi
Borehole Diameter: 10-inch	Casing Dia.: 0.5-inch	Casing Type: CPVC	Checked by: T. Cudzilo P.G.4473 <i>TJC</i>
Total Depth Drilled: 77 feet	Screen Intervals: 47-48/ 62-63		Slot Size: 0.020-inch
Sampling Method: Continuous Core	Top of Casing Elevations: NM		Ground Surface Elevation: NM

Northing: 2006922.532 Easting: 6728140.881

Comments: Continuous core from 35 to 77 feet bgs. GPS Northing and Easting data collected from center of borehole.

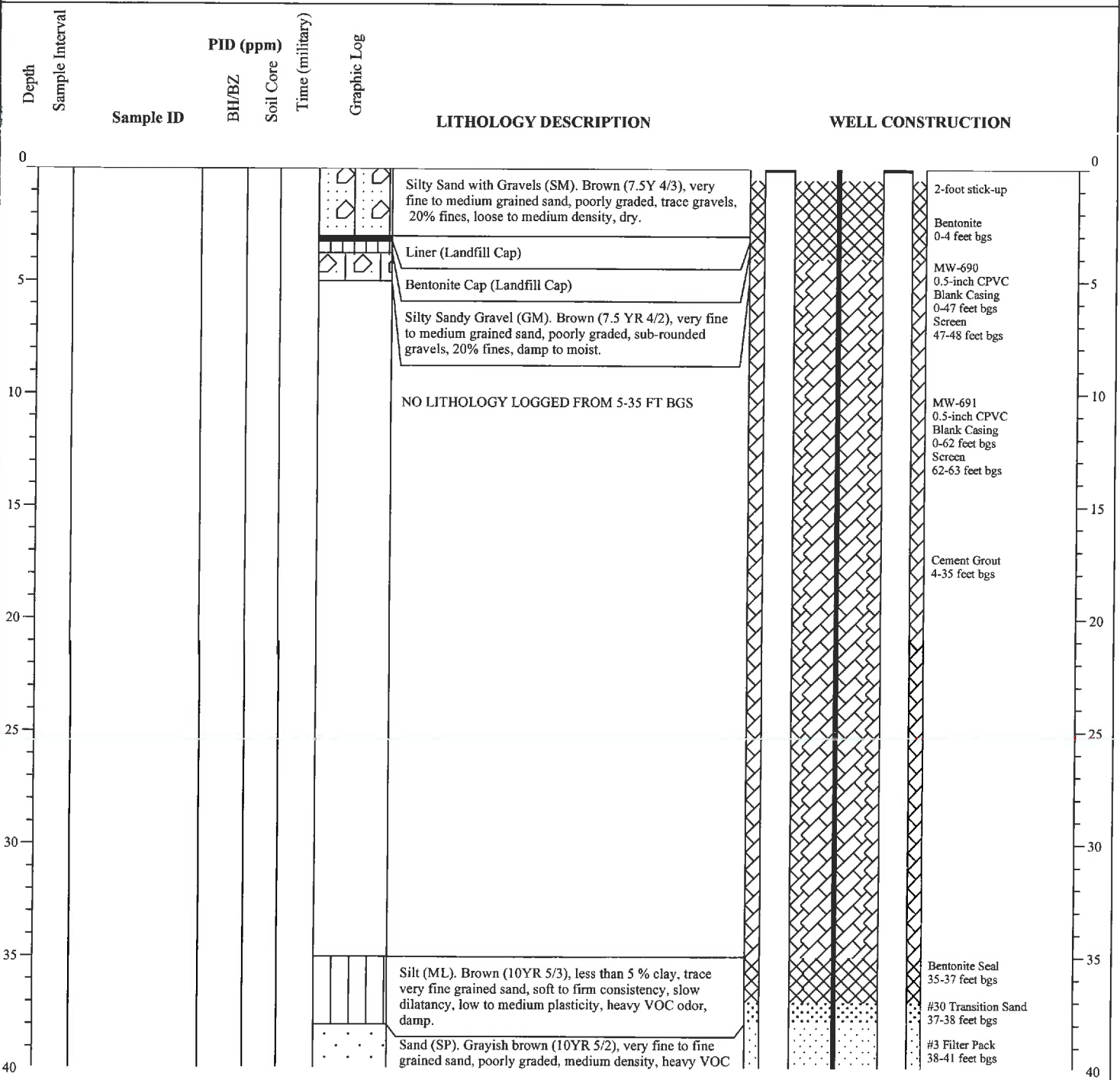

Drilling Contractor: National	Drilled by: James Freitas	Borehole Name: OUD-SB-XVMW3S/D	Logged By: J. Brandon
Drilling Method: HSA	Dates Drilled: 09/26/14-09/29/14	Well Construction: 10/01/14	QC: K. Touchi
Borehole Diameter: 10-inch	Casing Dia.: 0.5-inch	Casing Type: CPVC	Checked by: T. Cudzilo P.G.4473
Total Depth Drilled: 77 feet	Screen Intervals: 47-48/ 62-63		Slot Size: 0.020-inch
Sampling Method: Continuous Core	Top of Casing Elevations: NM		Ground Surface Elevation: NM

Northing: 2006922.532 Easting: 6728140.881

Comments: Continuous core from 35 to 77 feet bgs. GPS Northing and Easting data collected from center of borehole.

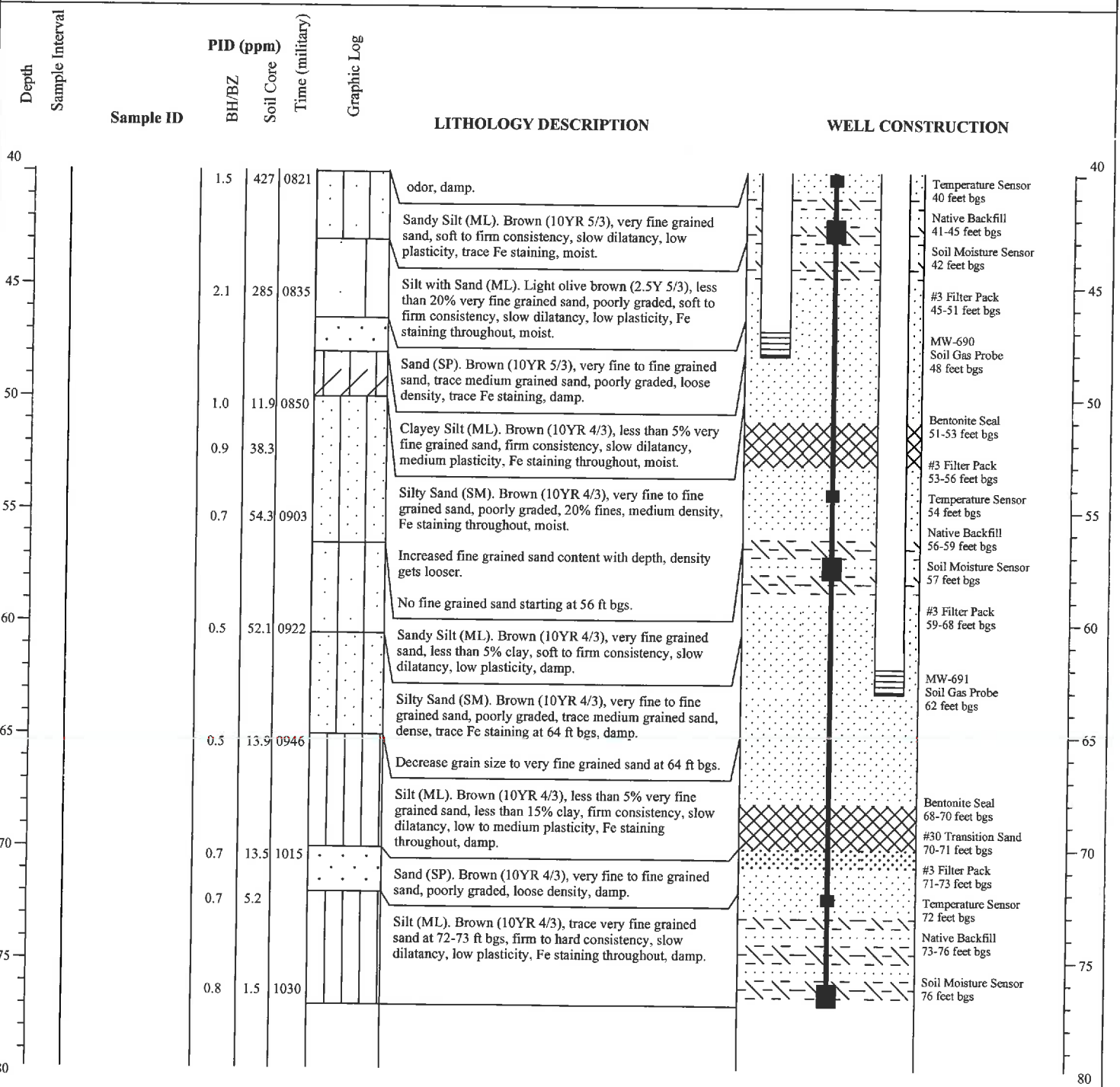

Project: OUD XSVE

Location: McClellan Park, Sacramento, CA

Project: 17327101

Log of Vapor Monitoring Wells:

MW-692, MW-693

Drilling Contractor: National	Drilled by: James Freitas	Borehole Name: OUD-SB-XVMW4S/D	Logged By: J. Brandon
Drilling Method: HSA	Dates Drilled: 10/01/14-10/02/14	Well Construction: 10/03/14	QC: K. Touchi
Borehole Diameter: 10-inch	Casing Dia.: 0.5-inch	Casing Type: CPVC	Checked by: T. Cudzilo P.G.4473 <i>TTC</i>
Total Depth Drilled: 77 feet	Screen Intervals: 47-48/ 62-63		Slot Size: 0.020-inch
Sampling Method: Continuous Core	Top of Casing Elevations: NM		Ground Surface Elevation: NM

Northing: 2006925.200 Easting: 6728130.255

Comments: Continuous core from 35 to 77 feet bgs. GPS Northing and Easting data collected from center of borehole.

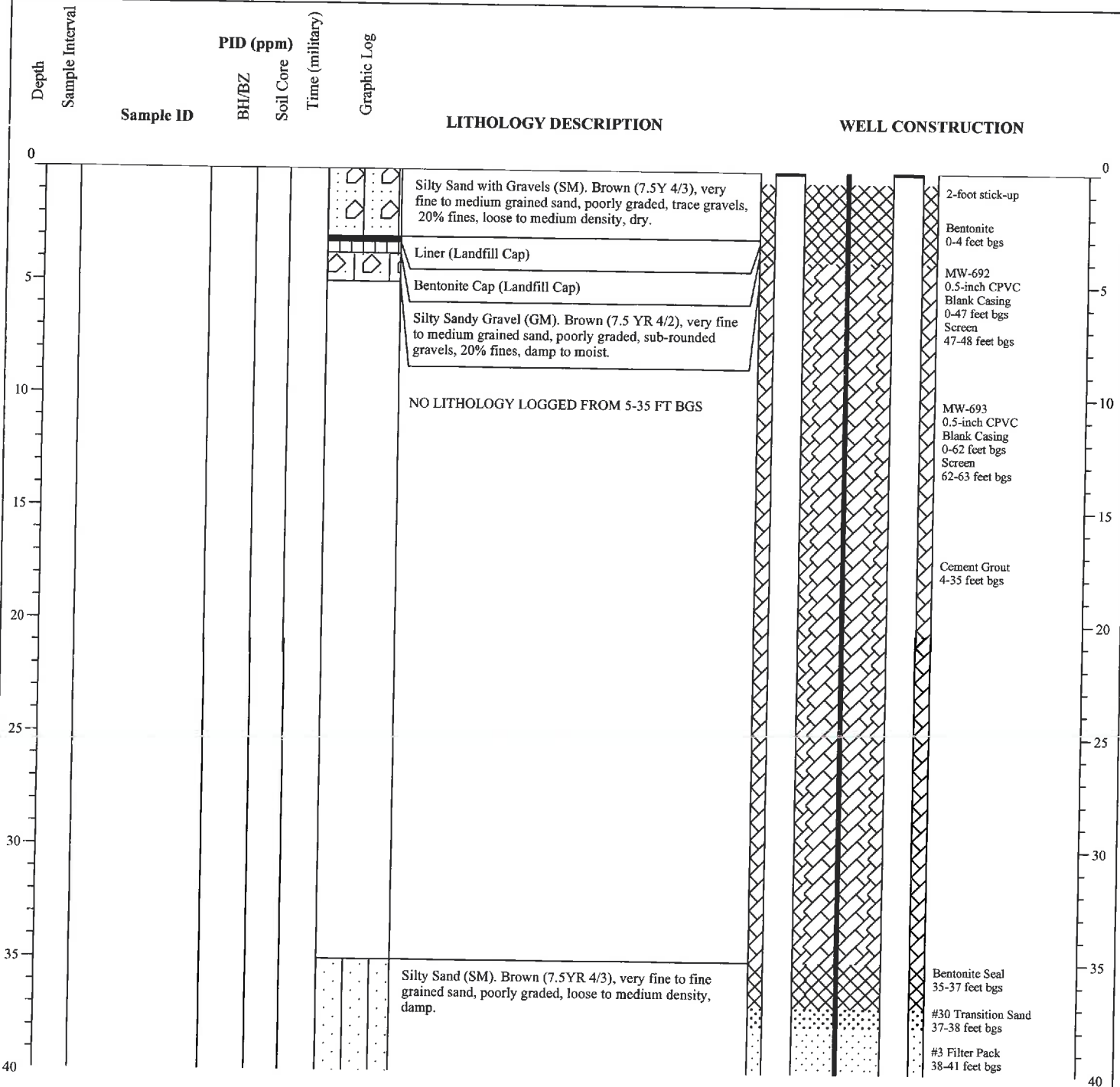

Drilling Contractor: National	Drilled by: James Freitas	Borehole Name: OUD-SB-XVMW4SD	Logged By: J. Brandon
Drilling Method: HSA	Dates Drilled: 10/01/14-10/02/14	Well Construction: 10/03/14	QC: K. Touchi
Borehole Diameter: 10-inch	Casing Dia.: 0.5-inch	Casing Type: CPVC	Checked by: T. Cudzilo P.G.4473
Total Depth Drilled: 77 feet	Screen Intervals: 47-48/ 62-63		Slot Size: 0.020-inch
Sampling Method: Continuous Core	Top of Casing Elevations: NM		Ground Surface Elevation: NM

Northing: 2006925.200 Easting: 6728130.255

Comments: Continuous core from 35 to 77 feet bgs. GPS Northing and Easting data collected from center of borehole.

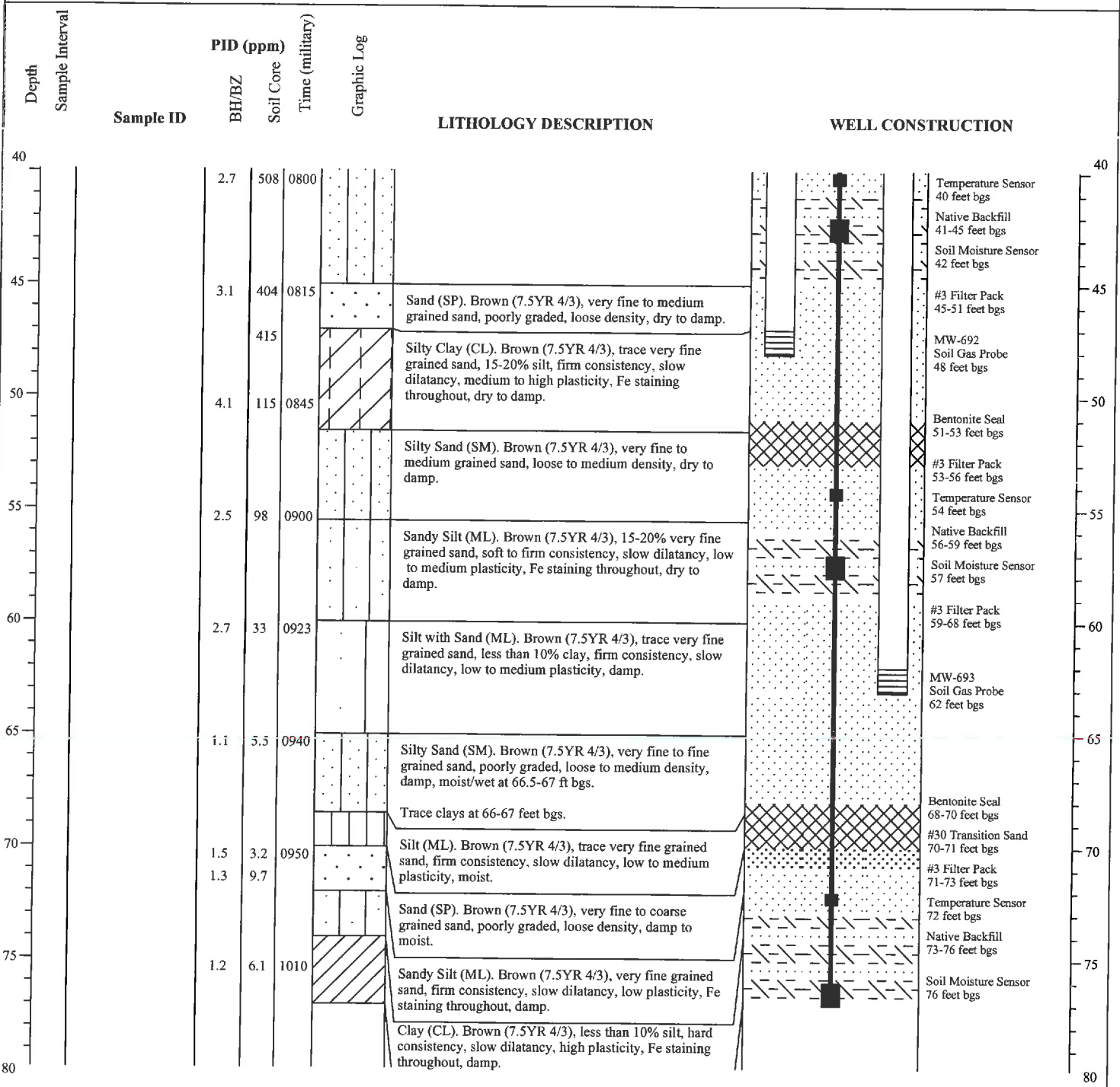

URS Log of Drilling Operations

Boring ID: 00DSB - POST 5

Installation: McClellan Project: X SVE Event: CONFIRMATION BORING

Total Depth (ft bgs): 75 Start Date: 12/8/15 Finish Date: 12/9/15

Geologist: J. Brandon Instrument/Units: _____

Drilling Company: NATIONAL EWP Driller: GARY WHITLEY

Drilling Method: HSA Rig Type: _____

Drill Bit Type and Size: 8"

Boring Location (Street Address or Description): _____

Depth Below Surface (ft)	Sample Interval	Core Run/ Recovery	Field Sample ID	BH/BZ (PID/FID)	Soil Core PID (ppm)	Time (Military)	Drilling Notes	Lithology	Depth Below Surface (ft)
0							DEAD HEAD TO 33 FT bgs		0
1									1
2									2
3									3
4									4
5									5
6									6
7									7
8									8
9									9
10									10

URS Log of Drilling Operations

Boring ID: 0UDSB-POST 5

Start Date: 12/8/15 Geologist: J. Brandon

Depth Below Surface (ft)	Sample Interval	Core Run/ Recovery	Field Sample ID	BH/BZ (PID/FID)	Soil Core PID (ppm)	Time (Military)	Drilling Notes	Lithology	Depth Below Surface (ft)
10							<p>DEAD HEAD TO 35 ft bgs</p>		10
11								11	
12								12	
13								13	
14								14	
15								15	
16								16	
17								17	
18								18	
19								19	
20								20	

URS Log of Drilling Operations

Boring ID: 0VDSB-Post5

Start Date: 12/8/15 Geologist: J. Brandon

Depth Below Surface (ft)	Sample Interval	Core Run/ Recovery	Field Sample ID	BH/BZ (PID/FID)	Soil Core PID (ppm)	Time (Military)	Drilling Notes	Lithology	Depth Below Surface (ft)
20									20
21									21
22									22
23							DEAD HEAD TO 33 FT bgs		23
24									24
25									25
26									26
27									27
28									28
29									29
30									30

URS Log of Drilling Operations

Boring ID: OUDSB-POST5

Start Date: 12/8/15 Geologist: J. Brandon

12/8

12/9

Depth Below Surface (ft)	Sample Interval	Core Run/ Recovery	Field Sample ID	BH/BZ (PID/FID)	Soil Core PID (ppm)	Time (Military)	Drilling Notes	Lithology	Depth Below Surface (ft)
30									30
31							DEAD HEAD TO 33 FT bgs		31
32									32
33				φ.φ	φ.φ				33
34							SANDY SILT (ML) BROWN (10yr 4/3) very fine to fine grained sand, poorly graded, soft - firm consistency, DAMP	ML	34
35		24/60							35
36									36
37									37
38				φ.φ	φ.φ				38
39							SAND w/ SILT (SP) BROWN (10yr 4/3) very fine to fine grained sand poorly graded, TRACE medium grained sand, loose density, Dry	SP	39
40									40

URS Log of Drilling Operations

Boring ID: OUDSB-Post5

Start Date: 12/9/15 Geologist: J. Brandon

Depth Below Surface (ft)	Sample Interval	Core Run/ Recovery	Field Sample ID	BH/BZ (PID/FID)	Soil Core PID (ppm)	Time (Military)	Drilling Notes	Lithology	Depth Below Surface (ft)
40									40
41		24/ 6φ							41
42							Sandy SILT (ML) Brown (10yr 4/3) very fine grained sand, trace fine grained firm consistency, Dry	ML	42
43				φ.φ	φ.φ				43
44									44
45		44/ 6φ							45
46			POST-5-4L GRAB			8830	Silty SAND (SM) Brown (10yr 4/3) very fine to fine grained sand, poorly graded, trace medium grained sand, Fe STAINING 44-47 ft bgs, DAMP TO moist.	SM	46
47							Decrease fine grained sand content w/depth		47
48				φ.φ	φ.φ				48
49									49
50							SILT (ML) Brown (10yr 4/3) Trace very fine grained sand, trace clays, Dry To DAMP, soft to firm	ML	50

URS Log of Drilling Operations

Boring ID: OVD5B-POST5

Start Date: 12/8/15 Geologist: J. Brandon

Depth Below Surface (ft)	Sample Interval	Core Run/ Recovery	Field Sample ID	BH/BZ (PID/FID)	Soil Core PID (ppm)	Time (Military)	Drilling Notes	Lithology	Depth Below Surface (ft)
50							SILT (ML)	ML	50
51		40/							51
52		60/					INCREASE FINE GRAINED SAND CONTENT @ 52 FT BGS		52
53				0.0	0.0				53
54							SANDY SILT (ML) BROWN (10/42 4/3) VERY FINE TO FINE GRAINED SAND, POORLY GRADED, SOFT TO FIRM CONSISTENCY	ML	54
55		50/	POST-5-55 GLAB			0907	DAMP TO MOIST w/ DEPTH		55
56		60/							56
57									57
58				0.0	0.0				58
59							INCREASE CLAY CONTENT @ 59.5 FT BGS		59
60									60

URS Log of Drilling Operations

Boring ID: 0VDSB-POSTS

Page 7 of 8

Start Date: 12/8/15 Geologist: J. Brandon

Depth Below Surface (ft)	Sample Interval	Core Run/ Recovery	Field Sample ID	BH/BZ (PID/FID)	Soil Core PID (ppm)	Time (Military)	Drilling Notes	Lithology	Depth Below Surface (ft)
60							sandy SILT w/ clay	ml	60
61		48/60							61
62							Fe STAINING Throughout 63-68 interval		62
63				Ø.Ø	Ø.Ø				63
64									64
65									65
66		33/60							66
67								ml	67
68				Ø.Ø	Ø.Ø		SILTY SAND (SM) BROWN (Ø yr 4/3) very fine grained sand, 40% SILT DAMP	SM	68
69							Decrease SILT CONTENT w/ DEPTH		69
70									70

URS Log of Drilling Operations

Boring ID: OUDSB-POST5

Start Date: 8/12/15 Geologist: J. Brandon

Depth Below Surface (ft)	Sample Interval	Core Run/Recovery	Field Sample ID	BH/BZ (PID/FID)	Soil Core PID (ppm)	Time (Military)	Drilling Notes	Lithology	Depth Below Surface (ft)
70									70
71		30/67					SAND (SP) BROWN (10yr 4/3) Very fine to medium grained SAND, poorly graded, loose to medium density, DAMP-WET.	SP	71
72									72
73				φ.φ	φ.φ				73
74	24/24		POST-S-74 GRAB			1055	SANDY SILT (ML) BROWN (10yr 4/3) very fine grained SAND, firm density, WET		74
75				φ.φ	φ.φ		TD = 75 ft bgs		75
76									76
77									77
78									78
79									79
80									80

URS Log of Drilling Operations

Boring ID: OUDSB-POST6

Page 1 of 8

Installation: McClellan Project: XSVE Event: Confirmation Boring
 Total Depth (ft bgs): 75 Start Date: 12/8/15 Finish Date: 12/8/15
 Geologist: J. Brandon Instrument/Units: _____
 Drilling Company: NATIONAL EWP Driller: Gary Whitley
 Drilling Method: HSA Rig Type: _____
 Drill Bit Type and Size: 8"
 Boring Location (Street Address or Description): _____

Depth Below Surface (ft)	Sample Interval	Core Run/ Recovery	Field Sample ID	BH/BZ (PID/FID)	Soil Core PID (ppm)	Time (Military)	Drilling Notes	Lithology	Depth Below Surface (ft)
0							<p style="font-size: 1.2em;">Dead Head To 33 ft bgs</p>		0
1									1
2									2
3									3
4									4
5									5
6									6
7									7
8									8
9									9
10									10

URS Log of Drilling Operations

Boring ID: 0VDSB-Post 6

Start Date: 12/8/15 Geologist: J. Brandon

Depth Below Surface (ft)	Sample Interval	Core Run/ Recovery	Field Sample ID	BH/BZ (PID/FID)	Soil Core PID (ppm)	Time (Military)	Drilling Notes	Lithology	Depth Below Surface (ft)
10									10
11									11
12									12
13							DEAD Head TO 33 FT bgs		13
14									14
15									15
16									16
17									17
18									18
19									19
20									20

URS Log of Drilling Operations

Boring ID: 0VDSB - Post 06

Start Date: 12/8/15

Geologist: J. BRANDON

Page 3 of 8

Depth Below Surface (ft)	Sample Interval	Core Run/ Recovery	Field Sample ID	BH/BZ (PID/FID)	Soil Core PID (ppm)	Time (Military)	Drilling Notes	Lithology	Depth Below Surface (ft)
20									20
21									21
22									22
23							DEAD HEAD TO 33 FT bgs		23
24									24
25									25
26									26
27									27
28									28
29									29
30									30

URS Log of Drilling Operations

Boring ID: 00VDSB-Post 6

Page 4 of 8

Start Date: 12/8/15 Geologist: J. Brandon

Depth Below Surface (ft)	Sample Interval	Core Run/ Recovery	Field Sample ID	BH/BZ (PID/FID)	Soil Core PID (ppm)	Time (Military)	Drilling Notes	Lithology	Depth Below Surface (ft)
30									30
31							DEAD HEAD TO 33 FT BSS		31
32									32
33				∅.∅	∅.∅				33
34		6∅/ 6∅					SANDY SILT (ML) BROWN (1.0 7 4/3) very fine TO fine grained sand, poorly graded, moist.	ml	34
35									35
36									36
37									37
38				∅.∅	∅.∅		Color change to light yellowish brown (2.57 6/3) @ 38 ft bgs Decrease fine grained sand content starting @ 38.5		38
39									39
40									40

URS Log of Drilling Operations

Boring ID: 0VDSB - Post 6

Start Date: 12/8/15 Geologist: J. Brandon

Depth Below Surface (ft)	Sample Interval	Core Run/ Recovery	Field Sample ID	BH/BZ (PID/FID)	Soil Core PID (ppm)	Time (Military)	Drilling Notes	Lithology	Depth Below Surface (ft)
40							Sandy SILT (ML)	ML	40
41		60/							41
42		60							42
43				0.0	0.0		Interbedded very fine to fine grained sand layers, poorly graded 44-48 ft bgs Dry		43
44								SP	44
45		30/							45
46		60							46
47									47
48				0.0	0.0		SALT SAND STARTING @ 48 ft bgs	ML	48
49									49
50									50

URS Log of Drilling Operations

Boring ID: OUDSB- Post 6

Start Date: 12/8/15 Geologist: J. Brandon

Depth Below Surface (ft)	Sample Interval	Core Run/ Recovery	Field Sample ID	BH/BZ (PID/FID)	Soil Core PID (ppm)	Time (Military)	Drilling Notes	Lithology	Depth Below Surface (ft)
50									50
51		60/60							51
52									52
53				∅-∅	∅-∅		SILTY SAND (SM) BROWN (10YR 4/3) very fine to fine grained sand, poorly graded, medium Density, DAME	SM	53
54									54
55	40/60		POST-6-55 Grab			1120			55
56									56
57									57
58				∅-∅	∅-∅				58
59									59
60									60

URS Log of Drilling Operations

Boring ID: 00DSB-Post 6

Start Date: 12/8/15 Geologist: J. Brandon

Depth Below Surface (ft)	Sample Interval	Core Run/ Recovery	Field Sample ID	BH/BZ (PID/FID)	Soil Core PID (ppm)	Time (Military)	Drilling Notes	Lithology	Depth Below Surface (ft)
60									60
61		50/60					S.A.A EXCEPT Day		61
62									62
63				Ø.Ø	Ø.Ø				63
64							SILTY SAND, DAMP TO MOIST		64
65		40/40							65
66			POST-6-66 GRAB			1145			66
67									67
68				Ø.Ø	Ø.Ø				68
69									69
70									70

URS Log of Drilling Operations

Boring ID: OUPSB-POST6

Start Date: 12/8/15 Geologist: J. Brandon

Depth Below Surface (ft)	Sample Interval	Core Run/ Recovery	Field Sample ID	BH/BZ (PID/FID)	Soil Core PID (ppm)	Time (Military)	Drilling Notes	Lithology	Depth Below Surface (ft)
70							SILTY SAND (SM)	SM	70
71		30 40 / 60					- DAME		71
72									72
73				∅.∅	∅.∅				73
74		24 / 24					SANDY SILT (ML) BROWN (18y24/3) very fine cased SAND, poorly graded, firm consistency, DAMP TO MOIST Fe STAINING THROUGHOUT	ML	74
75				∅.∅	∅.∅		TD = 75 ft bgs		75
76									76
77									77
78									78
79									79
80									80

URS Log of Drilling Operations

Boring ID: 0VDSB-Post7

Page 1 of 8

Installation: McClellan Project: XSVE Event: Confirmation Boring

Total Depth (ft bgs): 75 Start Date: 12/9/15 Finish Date: 12/9/15

Geologist: J. Brandon Instrument/Units: _____

Drilling Company: NATIONAL EWP Driller: GARY WHITLEY

Drilling Method: HSA Rig Type: _____

Drill Bit Type and Size: 8"

Boring Location (Street Address or Description): _____

Depth Below Surface (ft)	Sample Interval	Core Run/ Recovery	Field Sample ID	BH/BZ (PID/FID)	Soil Core PID (ppm)	Time (Military)	Drilling Notes	Lithology	Depth Below Surface (ft)
0									0
1									1
2									2
3							DEAD HEAD		3
4							TO 33 FT BGS		4
5									5
6									6
7									7
8									8
9									9
10									10

URS Log of Drilling Operations

Boring ID: 0VDSB - Post 7

Start Date: 12/9/15 Geologist: J. BRANDON

Depth Below Surface (ft)	Sample Interval	Core Run/ Recovery	Field Sample ID	BH/BZ (PID/FID)	Soil Core PID (ppm)	Time (Military)	Drilling Notes	Lithology	Depth Below Surface (ft)
10									10
11									11
12									12
13									13
14							DEAD HEAD TO 33 FT bgs		14
15									15
16									16
17									17
18									18
19									19
20									20

URS Log of Drilling Operations

Boring ID: 0UDSB-Post 7

Page 3 of 8

Start Date: 12/9/15 Geologist: J. Brandon

Depth Below Surface (ft)	Sample Interval	Core Run/ Recovery	Field Sample ID	BH/BZ (PID/FID)	Soil Core PID (ppm)	Time (Military)	Drilling Notes	Lithology	Depth Below Surface (ft)
20									20
21									21
22									22
23									23
24							DEAD HEAD TO 33 FT bgs		24
25									25
26									26
27									27
28									28
29									29
30									30

URS Log of Drilling Operations

Boring ID: OUDSB-Post 7

Page 4 of 8

Start Date: 12/9/15 Geologist: J. Brandon

Depth Below Surface (ft)	Sample Interval	Core Run/ Recovery	Field Sample ID	BH/BZ (PID/FID)	Soil Core PID (ppm)	Time (Military)	Drilling Notes	Lithology	Depth Below Surface (ft)
30									30
31							DEAD HEAD TO 33 FT bgs		31
32									32
33				Ø.Ø	Ø.Ø				33
34							SILTY SAND (SM) BROWN (1042 4/3) very fine to fine grained sand, poorly graded, medium to dense, MOIST, TRACE Fe STAINING	SM	34
35	4Ø /6Ø								35
36									36
37									37
38				Ø.Ø	Ø.Ø				38
39							SAND (SP) BROWN (1042 4/3) Very fine to fine grained sand, trace silt, dense, dry	SP	39
40									40

URS Log of Drilling Operations

Boring ID: OUDSB-POST 7

Start Date: 12/9/15 Geologist: J. Brandon

Depth Below Surface (ft)	Sample Interval	Core Run/ Recovery	Field Sample ID	BH/BZ (PID/FID)	Soil Core PID (ppm)	Time (Military)	Drilling Notes	Lithology	Depth Below Surface (ft)
40									40
41		35/16φ					SILTY SAND (SM) BROWN (10ye 4/3) very fine grained sand, Dense, Dry	SM	41
42									42
43				φ.φ	φ.φ				43
44									44
45		25/16φ							45
46									46
47							very fine grained, TRACE fine grained sand lenses 46 - 48 FT bgs		47
48				φ.φ	φ.φ				48
49							SILTY SAND AS ABOVE		49
50									50

URS Log of Drilling Operations

Boring ID: OUDSB-Post7

Start Date: 12/9/15 Geologist: J. Brandon

Depth Below Surface (ft)	Sample Interval	Core Run/Recovery	Field Sample ID	BH/BZ (PID/FID)	Soil Core PID (ppm)	Time (Military)	Drilling Notes	Lithology	Depth Below Surface (ft)
50									50
51		3p/6p					SAND (SP) BROWN (10YR 4/3) VERY FINE TO FINE GRAINED SAND, TRACE MEDIUM GRAINED, TRACE SILTS, DENSE, DAMP, TRACE Fe STAINING.	SP	51
52									52
53				Ø.Ø	Ø.Ø				53
54		5p/6p					SANDY SILT (ML) BROWN (10YR 4/3) VERY FINE GRAINED SAND, FIRM TO HARD CONSISTENCY, DAMP TO MOIST. Fe STAINING	ML	54
55									55
56							TRACE CLAY 56.5-58		56
57									57
58				Ø.Ø	Ø.Ø				58
59									59
60									60

URS Log of Drilling Operations

Boring ID: OUDSB-Post 7

Start Date: 12/9/15 Geologist: J. Brandon

Depth Below Surface (ft)	Sample Interval	Core Run/ Recovery	Field Sample ID	BH/BZ (PID/FID)	Soil Core PID (ppm)	Time (Military)	Drilling Notes	Lithology	Depth Below Surface (ft)
60									60
61		46/					SANDY SILT AS ABOVE	ML	61
62		60							62
63				φ.φ	φ.φ				63
64							SILTY SAND (SM) BROWN (10yr 4/3) VERY FINE TO FINE GRAINED SAND, TRACE MEDIUM, POORLY GRADED, DENSE, Fe STAINING THROUGHOUT, DAMP-MOIST	SM	64
65		35/							65
66		60							66
67									67
68				φ.φ	φ.φ				68
69									69
70									70

URS Log of Drilling Operations

Boring ID: OVD SB- Post 7

Start Date: 12/9/15 Geologist: J. Brandon

Depth Below Surface (ft)	Sample Interval	Core Run/ Recovery	Field Sample ID	BH/BZ (PID/FID)	Soil Core PID (ppm)	Time (Military)	Drilling Notes	Lithology	Depth Below Surface (ft)
70									70
71		29/6φ					Decrease silt content @ 7φ.5		71
72							SAND (SP) BROWN (10yr 4/3) very fine to medium grained sand, poorly graded, low density, Fe staining, DAMP-WET	SP	72
73				φ.φ	φ.φ		SANDY SILT (ML) BROWN (10yr 4/3) very fine grained sand, firm, wet	ML	73
74		24/24					CLAY (CL) BROWN (10yr 4/3) Trace fine grained sand mod plast, Hard consistency, DAMP-WET	CL	74
75				φ.φ	φ.φ				75
76							TD = 75 FT bgs		76
77									77
78									78
79									79
80									80

URS Log of Drilling Operations

Boring ID: 0VDSB-POST8

Page 1 of 3

Installation: McClellan Project: XSVE Event: Confirmation Borings

Total Depth (ft bgs): 78.5 Start Date: 12/7/15 Finish Date: 12/7/15

Geologist: J. Brandon Instrument/Units: _____

Drilling Company: NATIONAL EWP Driller: GARY WHITLEY

Drilling Method: HSA Rig Type: _____

Drill Bit Type and Size: 8"

Boring Location (Street Address or Description): _____

Depth Below Surface (ft)	Sample Interval	Core Run/Recovery	Field Sample ID	BH/BZ (PID/FID)	Soil Core PID (ppm)	Time (Military)	Drilling Notes	Lithology	Depth Below Surface (ft)
0									0
1									1
2									2
3									3
4									4
5									5
6									6
7									7
8									8
9									9
10									10

DEAD HEAD
TO 33.5 FTbgs

URS Log of Drilling Operations

Boring ID: 0VDSB-Post 8

Start Date: 12/7/15 Geologist: J. Brandon

Depth Below Surface (ft)	Sample Interval	Core Run/ Recovery	Field Sample ID	BH/BZ (PID/FID)	Soil Core PID (ppm)	Time (Military)	Drilling Notes	Lithology	Depth Below Surface (ft)
10							<p>Dead Head To 33.5 ft bgs</p>		10
11								11	
12								12	
13								13	
14								14	
15								15	
16								16	
17								17	
18								18	
19								19	
20							20		

URS Log of Drilling Operations

Boring ID: 0UDSB-POST8

Start Date: 12/7/15 Geologist: J. BRANDON

Depth Below Surface (ft)	Sample Interval	Core Run/ Recovery	Field Sample ID	BH/BZ (PID/FID)	Soil Core PID (ppm)	Time (Military)	Drilling Notes	Lithology	Depth Below Surface (ft)
20									20
21									21
22									22
23							DEAD HEAD TO 33.5 FT bgs		23
24									24
25									25
26									26
27									27
28									28
29									29
30									30

URS Log of Drilling Operations

Boring ID: 0VDSB-Post8

Start Date: 12/2/15 Geologist: J-Brandon

Page 4 of 8

Depth Below Surface (ft)	Sample Interval	Core Run/Recovery	Field Sample ID	BH/BZ (PID/FID)	Soil Core PID (ppm)	Time (Military)	Drilling Notes	Lithology	Depth Below Surface (ft)
30									30
31							DEAD HEAD TO 33.5 FT bgs		31
32									32
33									33
34				0.0	0.0		SANDY SILT (ML) BROWN (10yr 4/3) very fine to fine grained sand, Poorly graded, firm consistency, Dry to DAMP	ML	34
35		37/60							35
36									36
37									37
38									38
39			POST-8-38.5 GRAB			13 00	MOIST @ 38.5', collect grab sample		39
40							Color change to light yellowish brown (2.57 6/3) @ 39 FT bgs		40

URS Log of Drilling Operations

Boring ID: OUDSB-POST 8

Page 5 of 8

Start Date: 12/7/15 Geologist: J. BRANCON

Depth Below Surface (ft)	Sample Interval	Core Run/Recovery	Field Sample ID	BH/BZ (PID/FID)	Soil Core PID (ppm)	Time (Military)	Drilling Notes	Lithology	Depth Below Surface (ft)
40							SANDY SILT (ML) Dry	ML	40
41									41
42									42
43									43
44				Ø.Ø	Ø.Ø		slight moisture @ 43.5'		44
45									45
46									46
47							SAND (SP) BROWN (10 yr 4/3) Very fine to medium grained SAND, poorly graded, loose	SP	47
48			POST-8-48 GRAB			1340	Density		48
49				Ø.Ø	Ø.Ø		SANDY SILT (ML) light yellowish BROWN (2.57 6/3) V. fine grained SAND, poorly graded, TRACE fine grained SAND, Dry		49
50									50

URS Log of Drilling Operations

Boring ID: QVDSB-Post8

Start Date: 12/7/15 Geologist: J. BRANDON

Depth Below Surface (ft)	Sample Interval	Core Run/Recovery	Field Sample ID	BH/BZ (PID/FID)	Soil Core PID (ppm)	Time (Military)	Drilling Notes	Lithology	Depth Below Surface (ft)
50									50
51		43/68					Very fine to fine grained sand lens from 51.5 - 52.5 FT bgs. Dry		51
52						52			
53						53			
54									54
55		68/68							55
56									56
57									57
58									58
59			Post-8-58.5 GRAB	Ø.Ø	Ø.Ø	1435	DAMP @ 58.5, collect grab sample		59
60									60

URS Log of Drilling Operations

Boring ID: ND5B-Post8

Start Date: 12/7/15 Geologist: J. Brandon

Depth Below Surface (ft)	Sample Interval	Core Run/ Recovery	Field Sample ID	BH/BZ (PID/FID)	Soil Core PID (ppm)	Time (Military)	Drilling Notes	Lithology	Depth Below Surface (ft)
60							SANDY SILT (ML)	ML	60
61		32/ 60							61
62									62
63							DAMP @ 63-63.5 ft bgs Collect grab sample		63
64				Ø.Ø	Ø.Ø		SILT w/ SAND (ML) yellowish BROWN (10yr 5/6) TRACE V. FINE GRAINED SAND, FIRM CONSISTENCY, DAMP TO MOIST THROUGHOUT.	ML	64
65									65
66		Ø/ 60							66
67									67
68									68
69				Ø.Ø	Ø.Ø		SANDY SILT (ML) BROWN (10yr 4/3) V. FINE GRAINED SAND, TRACE FINE GRAINED, POORLY GRADED, FIRM, DAMP	ML	69
70									70

URS Log of Drilling Operations

Boring ID: 00DSB-Post8

Start Date: 12/7/15 Geologist: J. Brandon

Depth Below Surface (ft)	Sample Interval	Core Run/ Recovery	Field Sample ID	BH/BZ (PID/FID)	Soil Core PID (ppm)	Time (Military)	Drilling Notes	Lithology	Depth Below Surface (ft)
70							Sandy SILT (ML)	ML	70
71		41/68							71
72									72
73									73
74			POST8-73.5 GRAB	Ø.Ø	Ø.Ø	1517			74
75							Fe STAINING 75.5-78.5		75
76		36/68					MOIST		76
77									77
78									78
79							TD = 78.5 FT bgs		79
80									80

URS Log of Drilling Operations

Boring ID: 00D-SB-PSVE1

Page 1 of 3

Installation: McClellan Project: XSVE Event: Confirmation sampling

Total Depth (ft bgs): 75 Start Date: 12/10/15 Finish Date: 12/10/15

Geologist: J. BRANDON Instrument/Units: _____

Drilling Company: NATIONAL RWP Driller: Gary Whitley

Drilling Method: HSA Rig Type: _____

Drill Bit Type and Size: 8"

Boring Location (Street Address or Description): _____

Depth Below Surface (ft)	Sample Interval	Core Run/ Recovery	Field Sample ID	BH/BZ (PID/FID)	Soil Core PID (ppm)	Time (Military)	Drilling Notes	Lithology	Depth Below Surface (ft)
0									0
1									1
2									2
3							DEAD HEAD TO 33 FT bgs		3
4									4
5									5
6									6
7									7
8									8
9									9
10									10

URS Log of Drilling Operations

Boring ID: 0VDSB-PSVE1

Start Date: 12/18/15 Geologist: J. Brandon

Depth Below Surface (ft)	Sample Interval	Core Run/ Recovery	Field Sample ID	BH/BZ (PID/FID)	Soil Core PID (ppm)	Time (Military)	Drilling Notes	Lithology	Depth Below Surface (ft)
10									10
11									11
12									12
13									13
14							DEAD Head To 33 ft bgs		14
15									15
16									16
17									17
18									18
19									19
20									20

URS Log of Drilling Operations

Boring ID: 00DSB-PSVE1

Start Date: 12/10/15 Geologist: J. Brandon

Depth Below Surface (ft)	Sample Interval	Core Run/ Recovery	Field Sample ID	BH/BZ (PID/FID)	Soil Core PID (ppm)	Time (Military)	Drilling Notes	Lithology	Depth Below Surface (ft)
20									20
21									21
22									22
23									23
24							DEAD HEAD		24
25							TO 33 FT bgs		25
26									26
27									27
28									28
29									29
30									30

URS Log of Drilling Operations

Boring ID: OUDSB-PSVE1

Start Date: 12/10/15 Geologist: J. Brandon

Depth Below Surface (ft)	Sample Interval	Core Run/ Recovery	Field Sample ID	BH/BZ (PID/FID)	Soil Core PID (ppm)	Time (Military)	Drilling Notes	Lithology	Depth Below Surface (ft)
30									30
31							DEAD HEAD TO 33 FTBGS		31
32									32
33				φ.φ	φ.φ				33
34	33/66		PSVE1-34 GRAB			1104	SILT (ML) BROWN (10y2 1/3) TRACE very fine grained sand, firm consistency, DAMP	ML	34
35									35
36									36
37									37
38				φ.φ	φ.φ				38
39							SANDY SILT (ML) BROWN (10y2 1/3) very fine grained sand, poorly graded, firm Dry	ML	39
40									40

URS Log of Drilling Operations

Boring ID: 0VDSB-PSVE1

Page 5 of 8

Start Date: 12/10/15 Geologist: J. Brandon

Depth Below Surface (ft)	Sample Interval	Core Run/ Recovery	Field Sample ID	BH/BZ (PID/FID)	Soil Core PID (ppm)	Time (Military)	Drilling Notes	Lithology	Depth Below Surface (ft)
40							SANDY SILT (ML)	ml	40
41		27/60							41
42									42
43				∅-∅	∅-∅		SILTY SAND (SM) BROWN (∅ ₄₂ & 4/3) VERY FINE TO FINE GRAINED SAND, POORLY GRADED, LOW DENSITY, DRY	SM	43
44									44
45		30/60							45
46							DECREASE in FINE GRAINED SAND CONTENT @ 46 FT LGS		46
47									47
48				∅-∅	∅-∅		SANDY SILT (ML) BROWN (∅ ₄₇ & 4/3) VERY FINE GRAINED SAND, FIRM, TRACE Fe STAINING, DAMP	ml	48
49									49
50									50

URS Log of Drilling Operations

Boring ID: OUDSB-PSVE1

Page 6 of 8

Start Date: 12/18/15 Geologist: J. BRANDON

Depth Below Surface (ft)	Sample Interval	Core Run/ Recovery	Field Sample ID	BH/BZ (PID/FID)	Soil Core PID (ppm)	Time (Military)	Drilling Notes	Lithology	Depth Below Surface (ft)
50									50
51		36/ 60					SANDY SILT AS ABOVE, EXCEPT TRACE CLAYS @ 51 FT		51
52									52
53				Ø.Ø	Ø.Ø				53
54									54
55		37/ 60							55
56							S. A. A		56
57									57
58				Ø.Ø	Ø.Ø				58
59			PSVE1-59 GRAB			1233	SILTY SAND (SM) BROWN (10 YR 4/3) VERY FINE TO FINE GRAINED SAND, POORLY GRADED, MEDIUM DENSITY, DAMP TO MOIST	SM	59
60									60

URS Log of Drilling Operations

Boring ID: OUPSB-PSVE1

Start Date: 12/18/15 Geologist: J. BRANDON

Depth Below Surface (ft)	Sample Interval	Core Run/ Recovery	Field Sample ID	BH/BZ (PID/FID)	Soil Core PID (ppm)	Time (Military)	Drilling Notes	Lithology	Depth Below Surface (ft)
60									60
61	40/60						Sandy SILT (ML) Brown (10y2 4/3) very fine grained sand, firm consistency, Trace Fe staining, moist	ML	61
62									62
63				φ-φ	φ-φ				63
64							SILT w/ SAND (ML) Brown (10y2 4/3) very fine grained sand, firm consistency, Fe staining throughout	ML	64
65	32/60						MOIST.		65
66									66
67							Trace clays 67-68 ft bgs		67
68				φ-φ	φ-φ				68
69							SAND (SP) Brown (10y2 4/3) v. fine to medium grained sand, poorly graded, low density, dense	SO	69
70									70

URS Log of Drilling Operations

Boring ID: OUDSB-PSVE1

Start Date: 12/18/15 Geologist: J. Brandon

Depth Below Surface (ft)	Sample Interval	Core Run/Recovery	Field Sample ID	BH/BZ (PID/FID)	Soil Core PID (ppm)	Time (Military)	Drilling Notes	Lithology	Depth Below Surface (ft)
70								SS	70
71		36/ 160							71
72							SANDY SILT (ML) BROWN (10 yr 4/3) v. FINE GRAINED SAND, FIRM CONSISTENCY.	ML	72
73				∅.∅	∅.∅		DAMP		73
74		24/ 24							74
75							TD = 75 FT bgs		75
76									76
77									77
78									78
79									79
80									80

URS Well Construction Details

Well ID: MW-698

Boring ID: OUDSB-PSVE1

Supervised by: J. BRANSON Date Installed: 12/10/15

Installation: McClellan Project: XSVE Event: CONFIRMATION BORING

Drilling Company: NATIONAL EWP Location Proximity: _____ Location Description: OUD XSVE
 On Depot / Off Depot: _____

Construction Method: HSA

Drilling Method (if different): _____

Well Owner: _____

Well Owner's Address: _____

Well Owner's Telephone: _____

Survey Data
 Northing: _____

Easting: _____

Units for Coordinates: _____

Coordinate System: _____

Measuring Point Elevation/Units: _____

Surveyor/Survey Company: _____

Survey Date: _____

- Geohydrologic Zone**
- Aquifer
 - Confining Layer or Aquiclude
 - Lower or Confined Aquifer
 - Perched Aquifer
 - Surface Aquifer
 - Unsaturated Zone
 - Water Table Aquifer

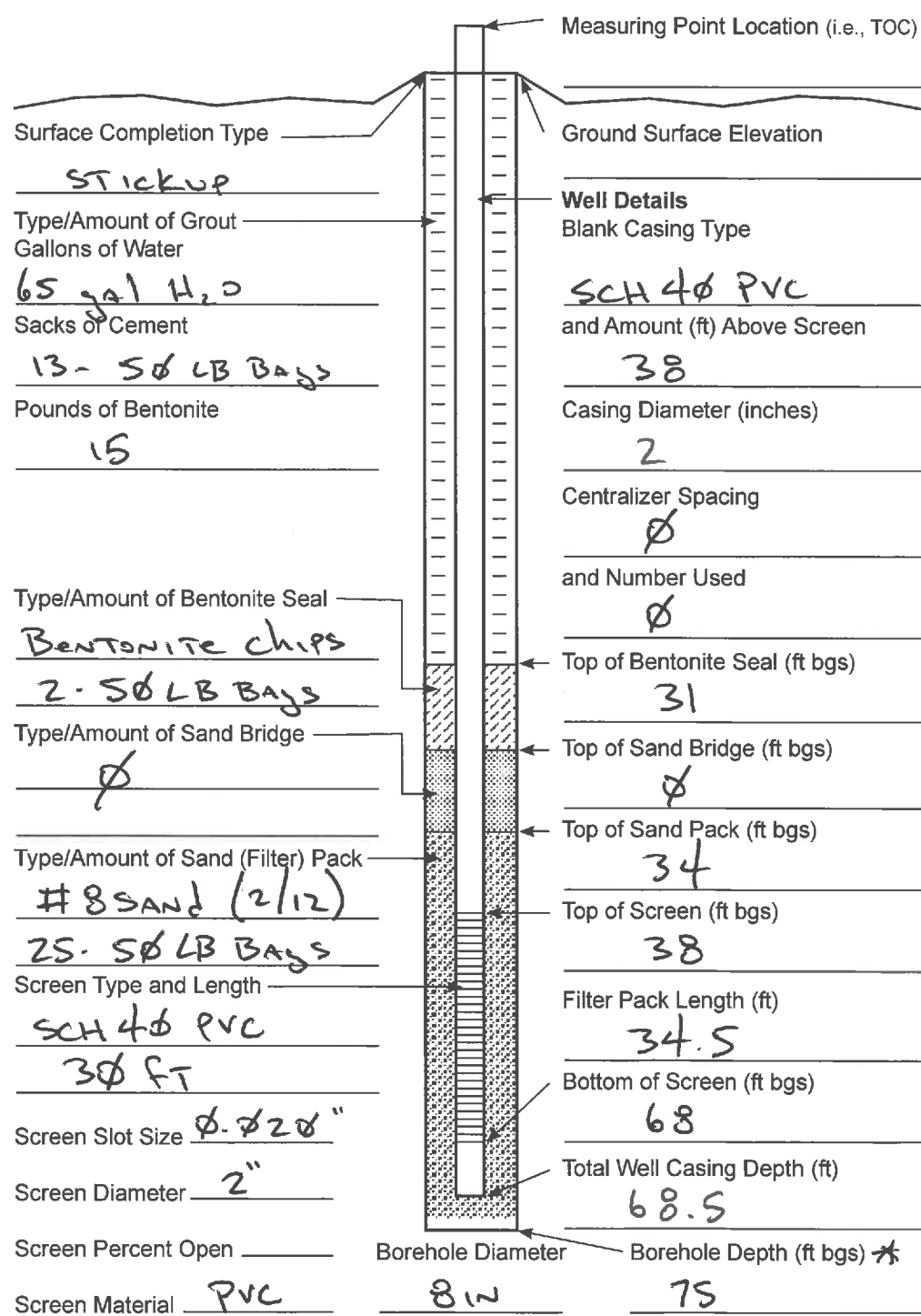

H:\Graphics\Data Mgmt\Tracy-Sharp\02-14-Sharp-Well-Construction-Data-Sheet.indd - VMG 02/21/14 SAC

* Borehole BACKfilled w/ BENTONITE 68.5 - 75 ft bgs

Page Intentionally Left Blank

**APPENDIX B AECOM, 2016, OPERABLE UNIT D LANDFILL CAP
INSPECTION AND MAINTENANCE REPORT**



**DEPARTMENT OF THE AIR FORCE
AIR FORCE CIVIL ENGINEER CENTER**

FEB 22 2016

MEMORANDUM FOR SEE DISTRIBUTION

**FROM: AFCEC/CIBW
3411 Olson Street
McClellan, CA 95652-1003**

SUBJECT: 2015 Annual Operable Unit (OU) D Landfill Cap Inspection and Maintenance Report, Former McClellan Air Force Base, California

The Air Force is pleased to submit the *2015 Annual Operable Unit D Landfill Cap Inspection and Maintenance Report, Former McClellan Air Force Base, California*. As previously agreed, the quarterly reports were submitted electronically.

This submission includes the completed OU D Cap Inspection form documenting the inspection findings for all four quarters in 2015.

If you have any questions or concerns regarding this report, please contact Mr. Ken Smarke at (916) 643-0830, ext. 235.

STEVEN K. MAYER, PMP, P.E.
BRAC Environmental Coordinator

**Attachment:
2015 Annual Operable Unit D Landfill Cap Inspection and Maintenance Report, Former McClellan Air Force Base, California**

DISTRIBUTION LIST

<u>Address</u>	<u>Number of Copies</u>
AFCEC/CIBW	
Attn: Administrative Record	1
Mr. Mike Swart	1
Mr. Ken Smarkel (Noblis)	1
3411 Olson Street	
McClellan, CA 95652-1003	
U.S. Environmental Protection Agency, Region IX	
Attn: Mr. Charnjit Bhullar (Mailstop S82)	1
75 Hawthorne Street	
San Francisco, CA 94105	
Dept. of Toxic Substances Control	
Attn: Mr. Stephen Pay	1
Ms. Lora Jameson	1
8800 Cal Center Drive	
Sacramento, CA 95826-3200	
Regional Water Quality Control Board	
Attn: Mr. James Taylor	
Mr. Walter Floyd	1
11020 Sun Center Drive #200	
Rancho Cordova, CA 95670-6114	
TechLaw Inc.	
Attn: Ms. Karla Brasaemle	1 CD
90 New Montgomery St., Ste. 710	
San Francisco, CA 94105	



60425195.18600784.40015

22 February 2016

AFCEC/CIBW
Attn: Mr. Joseph Ebert
3515 S. General McMullen
San Antonio, TX 78226-2018

SUBJECT: 2015 Annual Operable Unit D Landfill Cap Inspection and Maintenance Report, Former McClellan Air Force Base, California (Contract FA8903-09-D-85870004, PRJY 20127251A)

Dear Mr. Ebert:

URS is pleased to submit this *2015 Annual Operable Unit D Landfill Cap Inspection and Maintenance Report* for the former McClellan Air Force Base. The report summarizes 2015 cap inspection and maintenance activities and compiles information from the four quarterly cap inspection events documented by email only. Because this report includes factual information and observations, no comments are expected and it is being submitted as a final version.

This inspection report includes tabulated inspection results, details the inspection areas, any identified areas of deterioration or areas of repair, and the status of those repairs.

As agreed in the 24 January 2013 Base Closure Team meeting, quarterly inspection results and repairs for are documented by email only. Then this quarterly information is included in this Annual Report, which also includes photographs of the repair areas identified during inspections throughout the year.

Should you have any questions or need additional information, please call Steve Mayer at (916) 643-0830, ext. 224, or me at (916) 643-1818.

Sincerely,

Paul Graff
Project Manager

Enclosure

c: Kenneth Smarkel, Noblis, w/encl.
Steve Mayer, AFCEC, w/encl.
URS Group, Inc., Project File, w/encl.

REPORT DOCUMENTATION PAGEForm Approved
OMB No. 0704-0188

Public reporting burden for this collection of information is estimated to average 1 hour per response, including the time for reviewing instructions, searching existing data sources, gathering and maintaining the data needed, and completing and reviewing the collection of information. Send comments regarding this burden estimate or any other aspect of this collection of information, including suggestions for reducing this burden, to Washington Headquarters Services, Directorate for information Operations and Reports, 1215 Jefferson Davis Highway, Suite 1204, Arlington, VA 22202-4302, and to the Office of Management and Budget, Paperwork Reduction Project (0704-0188), Washington, DC 20503.

1. AGENCY USE ONLY (Leave blank)	2. REPORT DATE 22 February 2016	3. REPORT TYPE AND DATES COVERED Annual 2015/Fourth Quarter 2015	
4. TITLE AND SUBTITLE 2015 Annual Operable Unit D Landfill Cap Inspection and Maintenance Report		5. FUNDING NUMBERS Contract Delivery Order FA8903-09-D-8587/0004	
6. AUTHOR(S) URS Group, Inc.			
7. PERFORMING ORGANIZATION NAME(S) AND ADDRESS(ES) URS Group, Inc. 2870 Gateway Oaks Drive, Suite 150 Sacramento, CA 95833		8. PERFORMING ORGANIZATION REPORT NUMBER	
9. SPONSORING/MONITORING AGENCY NAME(S) AND ADDRESS(ES) AFCEC 2261 Hughes Avenue, Suite 155 Lackland AFB, TX 78236-9853		10. SPONSORING/MONITORING AGENCY REPORT NUMBER	
11. SUPPLEMENTARY NOTES			
12a. DISTRIBUTION/AVAILABILITY STATEMENT Unclassified/Unlimited		12b. DISTRIBUTION CODE	
13. ABSTRACT (Maximum 200 words) This report documents 2015 cap inspection and maintenance activities and compiles information from the first three quarterly cap inspection events.			
14. SUBJECT TERMS		15. NUMBER OF PAGES 44	
17. SECURITY CLASSIFICATION OF REPORT Unclassified	18. SECURITY CLASSIFICATION OF THIS PAGE Unclassified	17. SECURITY CLASSIFICATION OF REPORT Unclassified	18. SECURITY CLASSIFICATION OF THIS PAGE Unclassified

60425195.18600784.40015

Final

**OPERABLE UNIT D LANDFILL CAP INSPECTION
AND
MAINTENANCE REPORT
(Annual Report 2015)**

Prepared for:
Air Force Civil Engineer Center
(AFCEC)

Prepared by:

URS

URS Group, Inc.
2870 Gateway Oaks Dr., Suite 150
Sacramento, California 95833

Contract FA8903-09-D-8587

February 2016

NOTICE

This report was prepared by the staff of URS Group, Inc. (URS) under the supervision of registered professionals. The data interpretation, conclusions, and recommendations presented in the report were governed by URS' experience and professional judgment. This report has been prepared based on data current at the time of preparation. Assumptions based on this data, although believed reasonable and appropriate based on the data provided herein, may not prove to be true in the future as new data are collected. The conclusions and recommendations of URS are conditioned upon these assumptions.

TABLE OF CONTENTS

	<u>Page</u>
1.0 INTRODUCTION.....	1
1.1 Inspection Summary and Maintenance Update	1
2.0 OU D LANDFILL CAP INSPECTION.....	1
2.1 OU D Landfill Cap Inspection for 1Q15	2
2.2 OU D Landfill Cap Inspection for 2Q15	2
2.3 OU D Landfill Cap Inspection for 3Q15	3
2.4 OU D Landfill Cap Inspection for 4Q15	3
3.0 CONCLUSIONS.....	3
4.0 REFERENCES.....	4

TABLES

Table 2-1. Identified Repairs from the 1Q15 Inspection, January – March 2015.....	2
Table 2-2. Identified Repairs from the 2Q15 Inspection, May – June 2015.....	2
Table 2-3. Identified Repairs from the 3Q15 Inspection, 25 August 2015.....	3
Table 2-4. Identified Repairs from the 4Q15 Inspection, 15 November 2015.....	3

FIGURES

Figure 1. OU D Location Map and Quarterly Inspection Findings	2
Figure 2. OU D Landfill Cap Photographs, 3Q15	3

APPENDICES

- APPENDIX A – 1Q15 OU D Landfill Cap Inspection Forms
- APPENDIX B – 2Q15 OU D Landfill Cap Inspection Form
- APPENDIX C – 3Q15 OU D Landfill Cap Inspection Form
- APPENDIX D – 4Q15 OU D Landfill Cap Inspection Form
- APPENDIX E – OU D Landfill Cap Liner Repair

This page intentionally left blank

ABBREVIATIONS AND ACRONYMS

AFCEC	Air Force Civil Engineer Center
McClellan	former McClellan Air Force Base
OU	operable unit
O&M	operation and maintenance
SVE	soil vapor extraction
URS	URS Group, Inc.
1Q15	first quarter 2015

This page intentionally left blank

1.0 INTRODUCTION

URS Group, Inc. (URS) prepared this report for the Air Force Civil Engineer Center (AFCEC) under Contract FA4890-06-D-0006-0008. This report documents 2015 Operable Unit (OU) D landfill cap inspection and maintenance activities. The OU D site (DP178) is on the northwest side of the former McClellan Air Force Base (McClellan). Figure 1 presents the McClellan site map and OU D landfill site location.

As agreed in the 24 January 2013 Base Closure Team meeting, quarterly inspection results and repairs are documented by email only. All quarterly information for 2015 is included in this Annual Report; this report also includes photographs of the repair areas identified during inspections throughout the year.

Operation and maintenance (O&M) requirements of the OU D landfill cap are addressed in the *Final Operations and Maintenance Manual, Area D Cap* (O&M Manual) (CH2M HILL, 1986.)

The OU D landfill consists of 11 former disposal pits. Following landfill closure in 1995, a 10-acre, double-liner system cap was constructed using a layer of low-permeability clay covered with a 40-millimeter-thick, high-density polyethylene geomembrane to prevent infiltration of stormwater migrating through the waste and leaching potential contaminants to groundwater. The landfill cap was finished with a 2-foot-thick soil vegetation and drainage layer. The landfill drainage system consists of 1,900 feet of surface ditches and 1,000 feet of subsurface (slotted) collection and discharge pipeline. Remedial actions are ongoing with the use of a groundwater extraction system installed in 1986 and a soil vapor extraction (SVE) system installed in 1993. O&M of the groundwater and SVE systems is not included as part of this report.

1.1 Inspection Summary and Maintenance Update

To maintain the integrity and protectiveness of the cap, the cap and drainage systems were inspected on a monthly basis during the first quarter of 2015 (1Q15) and quarterly during 2Q15, 3Q15, and 4Q15 to identify any indications of deterioration due to aging or weathering, as well as signs of cap failure. Access roads, fences, surface runoff ditches, ground surface monuments, gas collection vents, and aboveground and overhead utilities were visually inspected. The landfill cap was inspected for signs of damage, unwanted vegetation growth, cracks, settling, and erosion as a result of weathering and events that may cause surface water run on and runoff to erode or otherwise damage the final cover system. Any noted locations exhibiting any of the previously mentioned failures require repair of the cap and drainage system, as needed, in accordance with the requirements in the O&M manual.

Also included in this 2015 Annual Report are the details of repairs made to the OUD cap liner conducted on 17 December 2015 (Appendix E). Repairs to 16 areas were conducted as part of the McClellan extreme soil vapor extraction (XSVE) project activities.

2.0 OU D LANDFILL CAP INSPECTION

This section presents notable findings from the 2015 inspections. Tables 2-1, 2-2, 2-3, and 2-4 list inspection findings, corresponding inspection area number, and status of the repairs for 1Q15, 2Q15, 3Q15, and 4Q15, respectively. Figure 1 shows each identified repair by inspection area number. Much of this information was already submitted in the quarterly inspection emails.

2.1 OU D Landfill Cap Inspection for 1Q15

The monthly 2015 (throughout 1Q15) inspections of the OU D Landfill cap occurred on 14 January, 11 February, and 12 March 2015. The inspections were performed by Erik Withey (URS) and attended by the McClellan Field Team representatives Gary Yuki (CNTS, on behalf of AFCEC), and/or Ken Smarkel (Noblis, on behalf of AFCEC). The inspection consisted of walking the entire site and examining the condition of the landfill cap. The landfill cap was inspected for signs of damage, subsidence, rodent burrows, proper drainage, roadway and fencing conditions, and other conditions that might cause damage to the landfill cap features or hinder its performance. Areas of concern were noted during the inspection and discussed with the McClellan Field Team representatives to determine the appropriate remedy. Table 2-1 summarizes housekeeping and repair activities performed during 1Q15. The inspection team used a Field Inspection Checklist form to document the inspection and track the status of issues identified during site inspections. Appendix A includes a copy of the Field Inspection Checklists used during the OU D landfill cap inspection. No photographs were taken during the 1Q15 OU D landfill cap inspection, as no findings were noted.

Table 2-1.
Identified Repairs from the 1Q15 Inspection, January – March 2015

Inspection Finding	Identified Repair/Housekeeping	Action	Repair Status
-	No findings noted.	-	-

1Q15 = first quarter 2015

2.2 OU D Landfill Cap Inspection for 2Q15

The 2Q15 inspections of the OU D landfill cap was conducted on 13 May 2015, with a follow-up inspection on 17 June 2015. Both inspections were conducted by Erik Withey (URS) and attended by McClellan Air Force representatives Gary Yuki (CNTS, on behalf of AFCEC) and Ken Smarkel (Noblis, on behalf of AFCEC). The inspection consisted of walking the entire site and examining the condition of the landfill cap. The landfill cap was inspected for signs of damage, subsidence, rodent burrows, proper drainage, roadway and fencing conditions, and other conditions that might cause damage to the landfill cap features or hinder its performance. Table 2-2 summarizes housekeeping and repair activities performed during the 2Q15 period. The inspection team used a Field Inspection Checklist form to document the inspection and ensure that all significant inspection issues were addressed. Appendix B includes a copy of the Field Inspection Checklist form used during the OU D landfill cap inspection. No photographs were taken during the 2Q15 OU D landfill cap inspection, as the only finding was to perform annual mowing.

Table 2-2.
Identified Repairs from the 2Q15 Inspection, May – June 2015

Inspection Finding	Identified Repair/Housekeeping	Action	Repair Status
14-01	Grass overgrown	Mow	Mowing completed on 15 June 2015.

2Q15 = second quarter 2015

2.3 OU D Landfill Cap Inspection for 3Q15

The 3Q15 inspection of the OU D landfill cap was conducted on 25 August 2015 by Erik Withey (URS), and was attended by McClellan Air Force representatives Gary Yuki (CNTS, on behalf of AFCEC) and Ken Smarkel (Noblis, on behalf of AFCEC). The inspection consisted of walking the entire site and examining the condition of the landfill cap. The landfill cap was inspected for signs of damage, subsidence, rodent burrows, proper drainage, roadway and fencing conditions, and other conditions that might cause damage to the landfill cap features or hinder its performance. Table 2-3 summarizes housekeeping and repair activities performed during the 3Q15 period. The inspection team used a Field Inspection Checklist form to document the inspection and ensure that all significant inspection issues were addressed. Appendix C includes a copy of the Field Inspection Checklist form used during the OU D landfill cap inspection. Figures 2 includes photographs taken during the 3Q15 OU D landfill cap inspection as well as photographs of maintenance performed.

Table 2-3.
Identified Repairs from the 3Q15 Inspection, 25 August 2015

Inspection Finding	Identified Repair/Housekeeping	Action	Repair Status
14-02	Trees growing at northeast end of OU D, along northern fence line	Remove trees	Completed 27 August 2015

OU = operable unit
3Q15 = third quarter 2015

2.4 OU D Landfill Cap Inspection for 4Q15

The 4Q15 inspection of the OU D landfill cap was conducted on 10 November 2015 by Erik Withey (URS), and was attended by McClellan Air Force representative Gary Yuki (CNTS, on behalf of AFCEC). The inspection consisted of walking the entire site and examining the condition of the landfill cap. The landfill cap was inspected for signs of damage, subsidence, rodent burrows, proper drainage, roadway and fencing conditions, and other conditions that might cause damage to the landfill cap features or hinder its performance. Table 2-4 summarizes housekeeping and repair activities performed during the 4Q15 period. The inspection team used a Field Inspection Checklist form to document the inspection and ensure that all significant inspection issues were addressed. Appendix D includes a copy of the Field Inspection Checklist form used during the OU D landfill cap inspection. No photographs taken during the 4Q15 OU D landfill cap inspection as no findings were noted.

Table 2-4.
Identified Repairs from the 4Q15 Inspection, 15 November 2015

Inspection Finding	Identified Repair/Housekeeping	Action	Repair Status
-	No findings noted.	-	-

4Q15 = fourth quarter 2015

3.0 CONCLUSIONS

The OU D cap was inspected each quarter in 2015; These inspections concluded that only minor maintenance is required. The cap appears to be functioning as designed. O&M of the cap will continue as required by the *Focused Strategic Sites Record of Decision* (CH2M HILL, 2012).

4.0 REFERENCES

CH2M HILL, 1986. *Operations and Maintenance Manual, Area D Cap, McClellan Air Force Base*.
December.

CH2M HILL, 2012. *Focused Strategic Sites Record of Decision*. February.

FIGURES

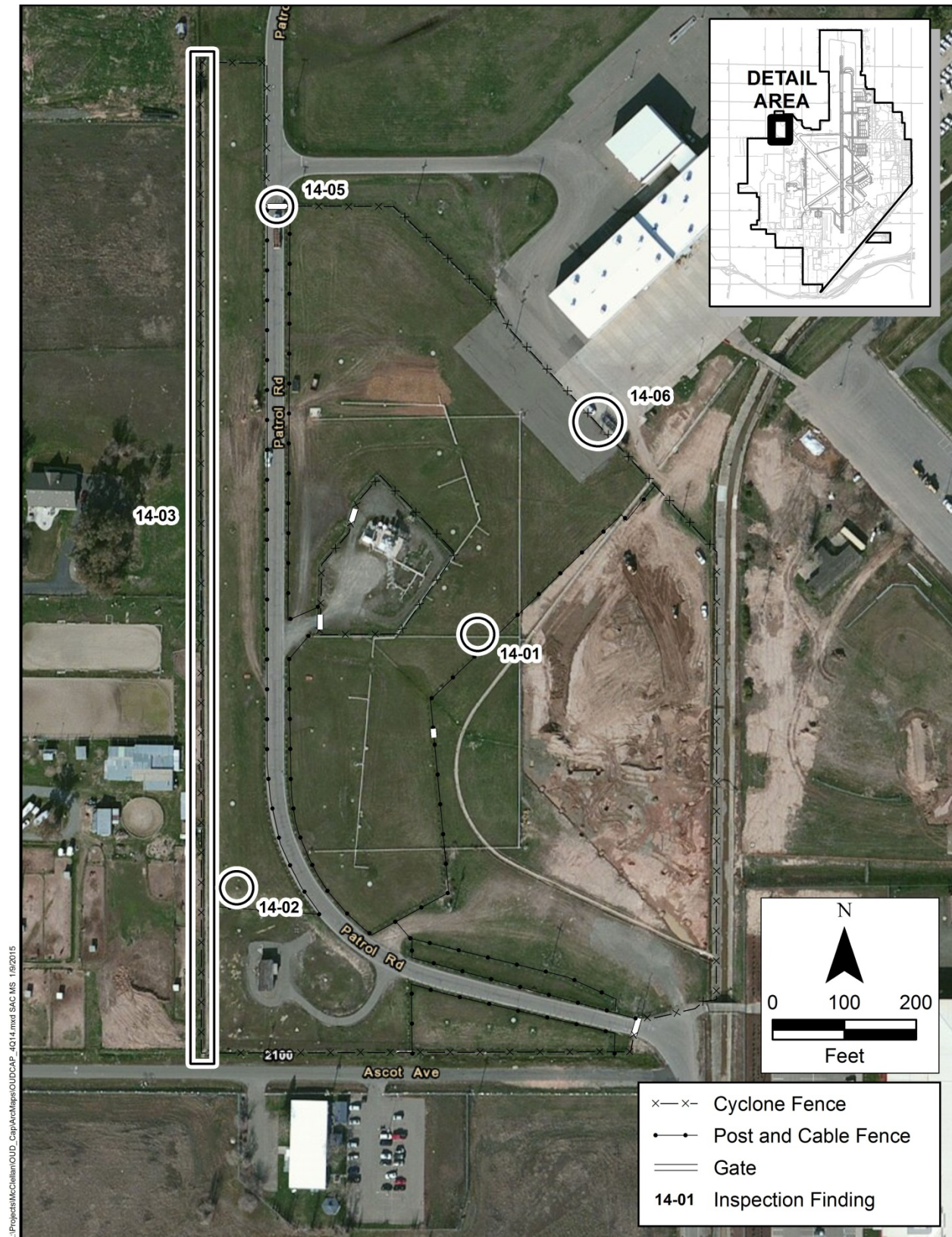

Figure 1. OU D Location Map and Quarterly Inspection Findings



Finding 14-02 Tree Removal Along Northern Fence line



Finding 14-02 Tree Removal Along Northern Fenceline

Figure 2. OU D Landfill Cap Photographs, 3Q15

APPENDIX A

1Q15 OU D Landfill Cap Inspection Forms

**Former McClellan AFB
OU D Landfill Cap Inspection**

Date: 14, JAN. 2015

Attendees: Keith Gary Kern

	Yes	No	Comments
1. Cap Condition - Damaged?		X	
- Subsidence?		X	
- Other corrective actions?		X	None
2. Bait Stations Maintained?	-	-	N/A
3. Drainage Channels Free?	X		
4. Slot Drainage Free?	X		
5. Annual Mowing Needed?		X	
6. Reseeding Needed?		X	
7. Herbicide Needed?		X	
8. Corrosion Control Needed?		X	
9. Fence/Gate Maintenance Needed?		X	

Other Comments: _____

There were NO FINDINGS - NO ACTION ITEMS AT THIS TIME.

Signed: Keith Gary Kern
[Signature]
[Signature]

Date: 1-14-15
1-14-15
1-14-15

Affiliation: NECOM
No 6145
OWTS

**Former McClellan AFB
OU D Landfill Cap Inspection**

Date: 2-11-15
Attendees: CARY Y. KEN S. ERIC W.

	Yes	No	Comments
1. Cap Condition - Damaged?		X	
- Subsidence?		X	
- Other corrective actions?			
2. Bait Stations Maintained?	X		
3. Drainage Channels Free?	X		
4. Slot Drainage Free?	X		
5. Annual Mowing Needed?		X	
6. Reseeding Needed?		X	
7. Herbicide Needed?		X	
8. Corrosion Control Needed?		X	
9. Fence/Gate Maintenance Needed?		X	

Other Comments: Cap is in good shape. No action items

Signed: Eric W.
Kenn S.
Cary Y.

Date: 2-11-15
2/11/15
2/11/15

Affiliation: AECOM
Noblis
CMS/AECC

**Former McClellan AFB
OU D Landfill Cap Inspection**

Date: 3-12-15
 Attendees: Gary Y. Erik W.

	Yes	No	Comments
1. Cap Condition - Damaged?		X	
- Subsidence?		X	No additional besides what it has been documented
- Other corrective actions?		X	
2. Bait Stations Maintained?	X		
3. Drainage Channels Free?	X		
4. Slot Drainage Free?	X		
5. Annual Mowing Needed?		X	MAY / JUNE
6. Reseeding Needed?		X	
7. Herbicide Needed?		X	
8. Corrosion Control Needed?		X	
9. Fence/Gate Maintenance Needed?		X	

Other Comments: NO ACTION ITEMS AT THIS TIME

Signed: Erik Witting
Erik W.

Date: 3-12-15
3-12-15

Affiliation: URS / AECOM
CWTS AFCEC

APPENDIX B

2Q15 OU D Landfill Cap Inspection Forms

**Former McClellan AFB
OU D Landfill Cap Inspection**

Date: 5-13-15
 Attendees: GARY - KPN - EIK

	Yes	No	Comments
1. Cap Condition - Damaged? <i>NO DAMAGE</i>		<input checked="" type="checkbox"/>	<i>Good</i>
- Subsidence? <i>NO SUBSIDENCE</i>		<input checked="" type="checkbox"/>	
- Other corrective actions? <i>SCHEDULE ANNUAL MOWING</i>			<i>MOWING - 1 CLEAN DRAINS</i>
2. Bait Stations Maintained?	<input checked="" type="checkbox"/>		
3. Drainage Channels Free?	<input checked="" type="checkbox"/>		
4. Slot Drainage Free?	<input checked="" type="checkbox"/>		
5. Annual Mowing Needed?	<input checked="" type="checkbox"/>		
6. Reseeding Needed?		<input checked="" type="checkbox"/>	
7. Herbicide Needed?		<input checked="" type="checkbox"/>	
8. Corrosion Control Needed?		<input checked="" type="checkbox"/>	
9. Fence/Gate Maintenance Needed?		<input checked="" type="checkbox"/>	

Other Comments: NO ACTION ITEMS (EXCEPT FOR ANNUAL MOWING)

Signed: *[Signature]*
[Signature]
[Signature]

Date: 5-13-15
5-13-15
5-13-15

Affiliation: ASCOM
Noblis
CNTS

**Former McClellan AFB
OU D Landfill Cap Inspection**

Date: 6-17-15

Attendees: ERIC, KEN S. GARY Y.

	Yes	No	Comments
1. Cap Condition - Damaged?		✓	
- Subsidence?		✓	
- Other corrective actions?		✓	
2. Bait Stations Maintained?	N/A	-	GONE/NO ACTIVITY
3. Drainage Channels Free?	✓		
4. Slot Drainage Free?	✓		
5. Annual Mowing Needed?		✓	mowed 6/15
6. Reseeding Needed?		✓	
7. Herbicide Needed?		✓	
8. Corrosion Control Needed?		✓	
9. Fence/Gate Maintenance Needed?		✓	

Other Comments: NO ACTION ITEMS AT THIS TIME -

Signed: *[Signature]*
[Signature]
[Signature]

Date: 6-17-15
6-17-15
6-17-15

Affiliation: ACCUM
Nobles
CNTS

APPENDIX C

3Q15 OU D Landfill Cap Inspection Form

**Former McClellan AFB
OU D Landfill Cap Inspection**

Date: 8-25-15
 Attendees: GARY Y. KEN S. SPURK W.

	Yes	No	Comments
1. Cap Condition - Damaged?		✓	
- Subsidence? NO		✓	NO NEW Subsidence
- Other corrective actions?	✓		TWO TREES ALONG FENCE
2. Bait Stations Maintained?	✓		
3. Drainage Channels Free?	✓		
4. Slot Drainage Free?	✓		
5. Annual Mowing Needed?		✓	
6. Reseeding Needed?		✓	
7. Herbicide Needed?		✓	
8. Corrosion Control Needed?		✓	
9. Fence/Gate Maintenance Needed?		✓	

Other Comments: ACTION ITEMS:
THERE ARE TWO TREES AT THE NORTH EAST
END ALONG THE FENCE THAT NEED TO BE REMOVED

Signed: Gary Y. Ken S. Spurk W. Date: 8-25-15 Affiliation: ASCOM
Ken S. Spurk W. 8-25-15 Nobles
[Signature] 8-25-15 CNSO

APPENDIX D

4Q15 OU D Landfill Cap Inspection Form

**Former McClellan AFB
OU D Landfill Cap Inspection**

Date: Nov. 10, 2015
 Attendees: Greg C. Erik W.

	Yes	No	Comments
1. Cap Condition - Damaged?		X	
- Subsidence?		X	
- Other corrective actions?		X	NONE AT THIS TIME
2. Bait Stations Maintained?	X		N/A
3. Drainage Channels Free?	X		
4. Slot Drainage Free?	X		
5. Annual Mowing Needed?		X	
6. Reseeding Needed?		X	
7. Herbicide Needed?		X	
8. Corrosion Control Needed?		X	
9. Fence/Gate Maintenance Needed?		X	

Other Comments: NO FINDINGS

Signed: Erik W.
DK

Date: 11-10-15
11-10-15

Affiliation: AECOM
CNTS

APPENDIX E

OU D Landfill Cap Liner Repair

Appendix E details repairs to the OUD cap liner conducted on 17 December 2015. Repairs to 16 areas of the liner were conducted as part of the McClellan extreme soil vapor extraction (XSVE) project field activities.

The XSVE project, conducted from 2014 to 2015, included the installation of a number of wells and soil borings which penetrated the OUD cap. Wells no longer required for continued remediation of the OUD site were decommissioned and details of the well decommissioning activities, conducted from 7 to 16 December 2015, will be detailed in the forthcoming decommissioning report, which will be included in the 2015 SVE Report (URS, pending). Site preparation for the mushroom cap part of the decommissioning work and the liner repair work was conducted from 14 to 16 December 2015.

Two types of liner repair were performed: 14 repairs were patches and 2 repairs. Boots were placed around well casing penetrations that will continue to operate as part of OUD SVE operations. The descriptions of the patch and boot repairs are provided in Table E-1. The locations of the proposed patches are shown on Figure E-1. The actual patches were performed on four vapor injection wells, four dual-completion vapor monitoring wells, SVE well VES-105 (abandoned prior to the start of XSVE operations), four confirmation soil borings, and an area of the liner near IW-21 that was damaged during excavation activities to repair the liner (see as-built drawing in Attachment E2-4). The boots sealed the liner around the two wells that remain in use (EW-503 and MW-698).

Repairs were performed by Wolf Environmental Lining Systems, Sutter Creek, California. Photos are provided in Attachment 1 and illustrate the patching and booting process, examples of completed patches and boots, vacuum testing of a patch repair, and the restored site. The test reports and associated as-built drawing, provided in Attachment E2-4, indicate that the liner was successfully repaired. The 14 patches passed the vacuum test and the 2 boots passed the spark test. After successful completion of the liner repair, the cap soils were replaced and compacted on 18 December 2015.

References:

URS Group Inc., pending. *2015 Soil Vapor Extraction/Bioventing Annual Monitoring Report. Sites 23C, 29/71, 37/39/54, 57, and 59.*

**Table E-1.
Liner Repair Summary
McClellan XSVE**

Liner Repair Location	Type of Liner Repair	GPS Coordinates		ID number (as-built drawing)	
		Northing	Easting		
Injection Wells installed for XSVE					
IW-21	Patch	2006912.228	6728129.306	P-13	
IW-22	Patch	2006915.536	6728149.786	P-9	
IW-23	Patch	2006934.071	6728147.019	P-13	
IW-24	Patch	2006931.750	6728127.661	P-6	
Dual-completion vapor monitoring wells installed for XSVE					
VMW-1	MW-686 / MW-687	Patch	2006920.042	6728135.443	P-10
VMW-2	MW-688 / MW-689	Patch	2006917.177	6728146.553	P-8
VMW-3	MW-690 / MW-691	Patch	2006926.487	6728141.093	P-3
VMW-4	MW-692 / MW-693	Patch	2006928.587	6728131.475	P-5
Extraction well abandoned for XSVE					
VES-105	Patch	2006907.228	6728144.731	P-12	
Soil confirmation boring installed post XSVE					
Post-5	Patch	2006921.438	6728143.079	P-7	
Post-6	Patch	2006915.913	6728132.474	P-11	
Post-7	Patch	2006925.447	6728134.000	P-4	
Post-8	Patch	2006929.234	6728145.151	P-2	
Area damaged by backhoe while clearing liner					
Damaged	Patch			P-14	
Extraction Well installed for XSVE					
EW-503	Boot	2006923.651	6728138.818	Boot1	
Vapor monitoring well installed post XSVE					
MW-698	Boot	2006923.628	6728136.057	Boot 2	

EW = extraction well
GPS = global positioning system
ID = identification
IW = injection well
MW = monitoring well
VES = vapor extraction well
VMW = vapor monitoring well
XSVE = extreme soil vapor extraction well

ATTACHMENT 1

XSVE Liner Repair Photographs



Photo 1. Roughing up surfaces of the high-density polyethylene liner.



Photo 1. Welding process.



Photo 3. Adding the bead.



Photo 4. Vacuum Test on a patch.



Photo 5. Boot installation.



Photo 6. Example patches and boots.



Photo 7. Backfill and compaction.



Photo 8. Site after cap restoration.

ATTACHMENT 2

XSVE Liner Repair

Attachment E2-1: Wolf ELS - Geosynthetic Material and Installation Acceptance

WOLF ELS

Geosynthetic Material and Installation Acceptance

Project Name: McClellan XSVE	Customer: AECOM (URS Group)
Project Number: 60424105.17327101.14001 PRSC15S1045	Date: December 17, 2015
Location: McClellan, CA	Area 50 sq. ft.

This Acceptance Certificate will accurately define the Scope of Work, which has been completed by Wolf ELS in compliance with Project Plans and Specifications. By completing this Scope of Work, Wolf ELS will transfer Title to the Owner, so that additional work and use of it can proceed. Other documents may be submitted after completion.

Description of Geosynthetic Materials and Area Accepted by Owner

Extrusion Welded and Tested 40-mil HDPE Smooth Liner – 14 Patches and 2 Boots

Rental Equipment Returned:	Yes ✓	No	Return Date: December 17, 2015	Release No. 1
Material Left on-Site:	Yes	No ✓	Returned to Wolf ELS:	Yes Date: December 17, 2015
Clean-Up Complete:	Yes ✓	No		

Wolf ELS:	Owner:

Acceptance Number: "1" Area Accepted: 50 sq ft

Attachment E2-2: Wolf ELS - Trial Weld Log

Trial welds ensure that vendor's new material will thermo-weld to the OUD liner material.

Temperatures are in units of degree Fahrenheit (°F) for the following:

- Ambient Air
- Wedge Temp or mass Temp
- Speed or Preheat Temp

ppi = Pound Per Inch

Attachment E2-3: Wolf ELS – Non-Destructive Test/Repair Log

Test locations are shown on the as-built drawing; patch IDs are shown on Table E-1

Testing conducted on the 14 Patches:

A= Air Test

V=Vacuum Test

All tests conducted by vacuum test

Testing conducted on the 2 Boots:

All tests conducted by spark test

WOLF ELS

Non-Destructive Test/Repair Log

Project Name: McClellan XSVE	Sheet Thickness/mil: 40 MIL
Job Number: 60424105.17327101.14001 PRSC151045	
Location: McClellan, CA	
Wolf ELS Technician: Wolfgang Voelcker	

Patch No.	Date of Test	Type Test (A or V)	QA/QC Technician	5 Minute Air Pressure Test		Or 15 Sec. Test Vacuum	No. of Repairs	Repair Locations	Acceptance Date
				p.s.i. Before	p.s.i. After				
1	Dec 17/15	V	W.V.	N/A	N/A	v	0		Dec 17/15
2	Dec 17/15	V	W.V.			v	0		Dec 17/15
3	Dec 17/15	V	W.V.			v	0		Dec 17/15
4	Dec 17/15	V	W.V.			v	0		Dec 17/15
5	Dec 17/15	V	W.V.			v	0		Dec 17/15
6	Dec 17/15	V	W.V.			v	0		Dec 17/15
7	Dec 17/15	V	W.V.			v	0		Dec 17/15
8	Dec 17/15	V	W.V.			v	0		Dec 17/15
9	Dec 17/15	V	W.V.			v	0		Dec 17/15
10	Dec 17/15	V	W.V.			v	0		Dec 17/15
11	Dec 17/15	V	W.V.			v	0		Dec 17/15
12	Dec 17/15	V	W.V.			v	0		Dec 17/15
13	Dec 17/15	V	W.V.			v	0		Dec 17/15
14	Dec 17/15	V	W.V.			v	0		Dec 17/15
Boot 1	Dec 17/15	Spark Test							Dec 17/15
Boot 2	Dec 17/15	Spark Test							Dec 17/15

Attachment E2-4: As-Built Drawing

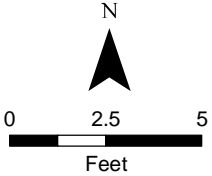
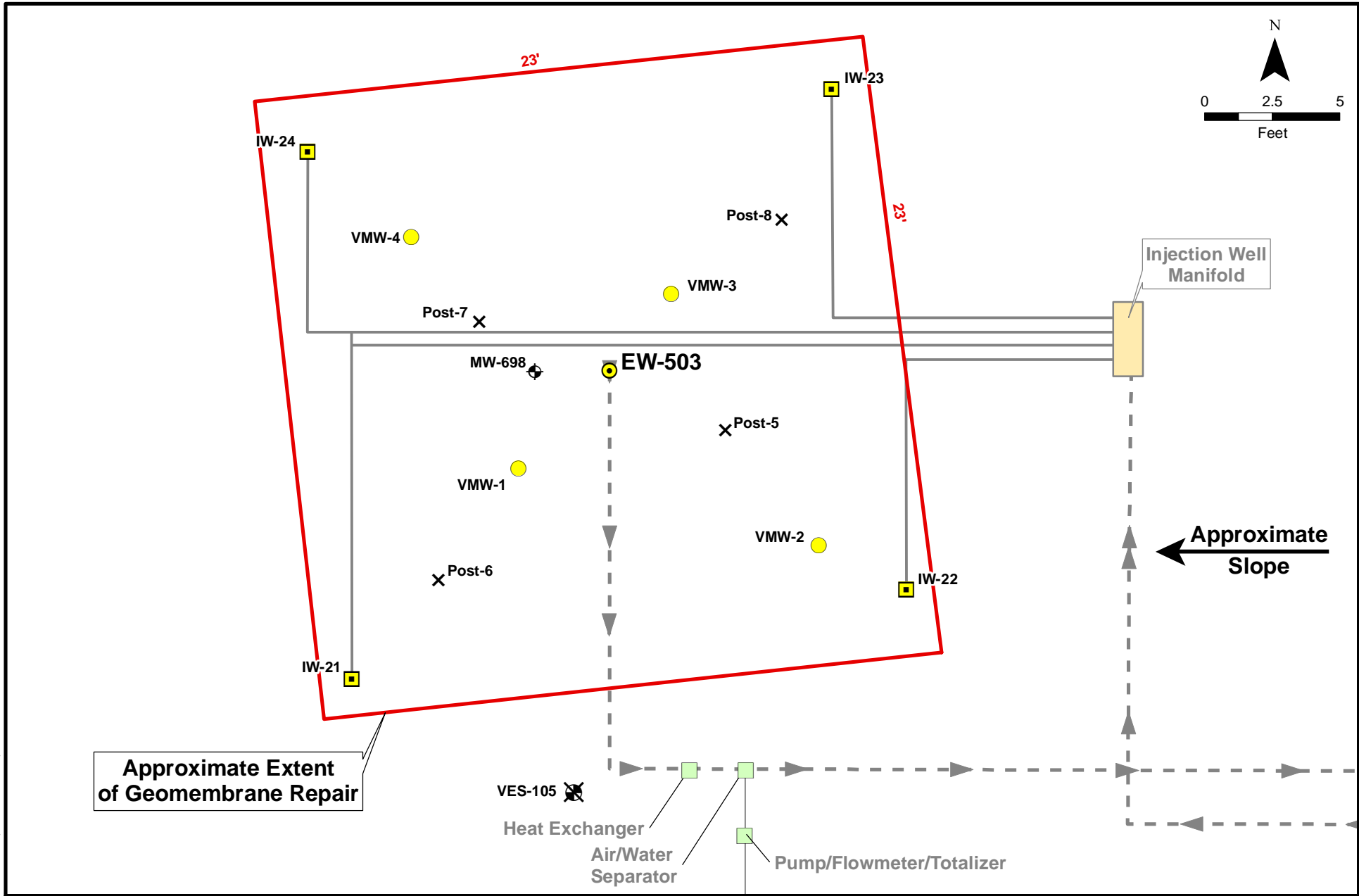

Approximate Extent of Geomembrane Repair

Approximate Slope

- Extraction Well
- Decommissioned Injection Well
- Decommissioned Vapor Monitoring Well
- ✕ Confirmation Soil Boring
- ✕ Decommissioned SVE Well
- ⊕ Monitoring Well



**XSVE Liner Repair
OU D**

Former McClellan AFB

Figure E-1

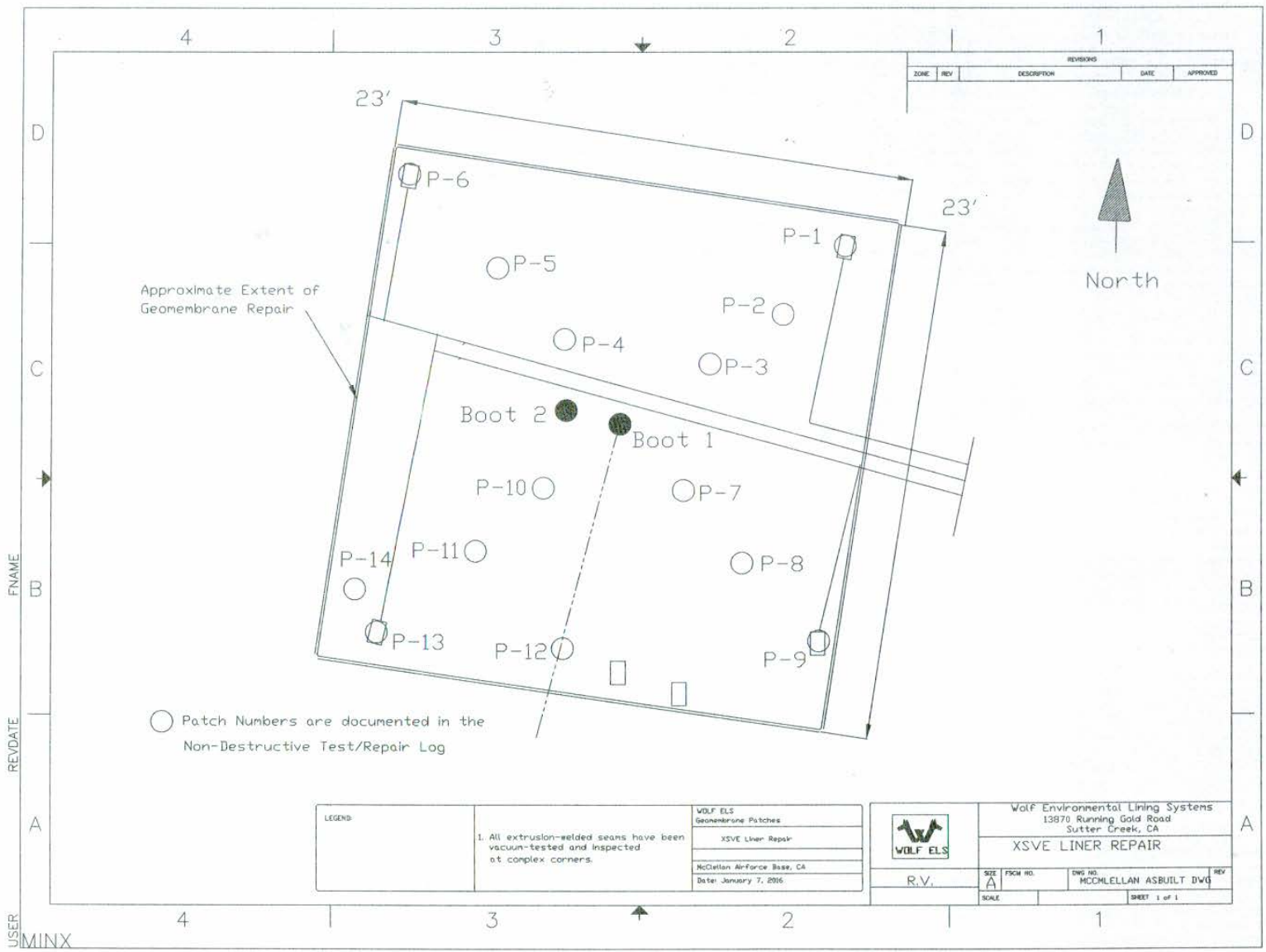

USER
MINX